

# FLEX I/O 220V AC Digital Input and Output Modules

Catalog Numbers 1794-IM8, 1794-OM8

<b>Topic</b>	<b>Page</b>
Important User Information	2
Environment and Enclosure	3
North American Hazardous Location Approval	4
Prevent Electrostatic Discharge	5
Installing Your 220V AC Digital Input or Output Module	7
Configure Your AC Module	10
Specifications	12
Derating Curves	17

## Important User Information

Solid-state equipment has operational characteristics differing from those of electromechanical equipment. Safety Guidelines for the Application, Installation and Maintenance of Solid-state Controls (Publication [SGL-1.1](#) available from your local Rockwell Automation sales office or online at <http://www.rockwellautomation.com/literature/>) describes some important differences between solid-state equipment and hard-wired electromechanical devices. Because of this difference, and also because of the wide variety of uses for solid-state equipment, all persons responsible for applying this equipment must satisfy themselves that each intended application of this equipment is acceptable.

In no event will Rockwell Automation, Inc. be responsible or liable for indirect or consequential damages resulting from the use or application of this equipment.

The examples and diagrams in this manual are included solely for illustrative purposes. Because of the many variables and requirements that are associated with any particular installation, Rockwell Automation, Inc. cannot assume responsibility or liability for actual use based on the examples and diagrams.

No patent liability is assumed by Rockwell Automation, Inc. with respect to use of information, circuits, equipment, or software described in this manual.

Reproduction of the contents of this manual, in whole or in part, without written permission of Rockwell Automation, Inc., is prohibited.

Throughout this manual, when necessary, we use notes to make you aware of safety considerations.

	<b>WARNING:</b> Identifies information about practices or circumstances that can cause an explosion in a hazardous environment, which may lead to personal injury or death, property damage, or economic loss.
	<b>ATTENTION:</b> Identifies information about practices or circumstances that can lead to personal injury or death, property damage, or economic loss. Attentions help you identify a hazard, avoid a hazard and recognize the consequences.
	<b>SHOCK HAZARD:</b> Labels may be on or inside the equipment (for example, drive or motor) to alert people that dangerous voltage may be present.
	<b>BURN HAZARD:</b> Labels may be on or inside the equipment (for example, drive or motor) to alert people that surfaces may reach dangerous temperatures.
<b>IMPORTANT</b>	Identifies information that is critical for successful application and understanding of the product.

## Environment and Enclosure

---



**ATTENTION:** This equipment is intended for use in a Pollution Degree 2 industrial environment, in overvoltage Category II applications (as defined in EN/IEC 60664-1), at altitudes up to 2000 m (6562 ft) without derating.

This equipment is not intended for use in residential environments and may not provide adequate protection to radio communication services in such environments.

This equipment is supplied as open-type equipment for indoor use. It must be mounted within an enclosure that is suitably designed for those specific environmental conditions that will be present and appropriately designed to prevent personal injury resulting from accessibility to live parts. The enclosure must have suitable flame-retardant properties to prevent or minimize the spread of flame, complying with a flame spread rating of 5V A or be approved for the application if nonmetallic. The interior of the enclosure must be accessible only by the use of a tool. Subsequent sections of this publication may contain more information regarding specific enclosure type ratings that are required to comply with certain product safety certifications.

In addition to this publication, see the following:

- Industrial Automation Wiring and Grounding Guidelines, publication [1770-4.1](#), for additional installation requirements.
  - NEMA Standard 250 and EN/IEC 60529, as applicable, for explanations of the degrees of protection provided by enclosures.
- 





**ATTENTION:** Read this document and the documents listed in the Additional Resources section about installation, configuration, and operation of this equipment before you install, configure, operate, or maintain this product. Users are required to familiarize themselves with installation and wiring instructions in addition to requirements of all applicable codes, laws, and standards.

Installation, adjustments, putting into service, use, assembly, disassembly, and maintenance are required to be carried out by suitably trained personnel in accordance with applicable code of practice. In case of malfunction or damage, no attempts at repair should be made. The module should be returned to the manufacturer for repair. Do not dismantle the module.

---

## North American Hazardous Location Approval

The following modules are North American Hazardous Location approved:  
1794-IM8, 1794-OM8.

The Following Information Applies When Operating This Equipment In Hazardous Locations.	Informations sur l'utilisation de cet équipement en environnements dangereux.
<p>Products marked "CL I, DIV 2, GP A, B, C, D" are suitable for use in Class I Division 2 Groups A, B, C, D, Hazardous Locations and nonhazardous locations only. Each product is supplied with markings on the rating nameplate indicating the hazardous location temperature code. When combining products within a system, the most adverse temperature code (lowest "T" number) may be used to help determine the overall temperature code of the system. Combinations of equipment in your system are subject to investigation by the local Authority Having Jurisdiction at the time of installation.</p>	<p>Les produits marqués "CL I, DIV 2, GP A, B, C, D" ne conviennent qu'à une utilisation en environnements de Classe I Division 2 Groupes A, B, C, D dangereux et non dangereux. Chaque produit est livré avec des marquages sur sa plaque d'identification qui indiquent le code de température pour les environnements dangereux. Lorsque plusieurs produits sont combinés dans un système, le code de température le plus défavorable (code de température le plus faible) peut être utilisé pour déterminer le code de température global du système. Les combinaisons d'équipements dans le système sont sujettes à inspection par les autorités locales qualifiées au moment de l'installation.</p>
<div style="display: flex; align-items: center;">  <div> <p><b>WARNING:</b> <b>Explosion Hazard –</b></p> <ul style="list-style-type: none"> <li>• Do not disconnect equipment unless power has been removed or the area is known to be nonhazardous.</li> <li>• Do not disconnect connections to this equipment unless power has been removed or the area is known to be nonhazardous. Secure any external connections that mate to this equipment by using screws, sliding latches, threaded connectors, or other means provided with this product.</li> <li>• Substitution of components may impair suitability for Class I, Division 2.</li> </ul> </div> </div>	<div style="display: flex; align-items: center;">  <div> <p><b>AVERTISSEMENT:</b> <b>Risque d'Explosion –</b></p> <ul style="list-style-type: none"> <li>• Couper le courant ou s'assurer que l'environnement est classé non dangereux avant de débrancher l'équipement.</li> <li>• Couper le courant ou s'assurer que l'environnement est classé non dangereux avant de débrancher les connecteurs. Fixer tous les connecteurs externes reliés à cet équipement à l'aide de vis, loquets coulissants, connecteurs filetés ou autres moyens fournis avec ce produit.</li> <li>• La substitution de composants peut rendre cet équipement inadapté à une utilisation en environnement de Classe I, Division 2.</li> </ul> </div> </div>



**WARNING:** When used in a Class I, Division 2, hazardous location, this equipment must be mounted in a suitable enclosure with proper wiring method that complies with the governing electrical codes.

## Prevent Electrostatic Discharge

---



**ATTENTION:** This equipment is sensitive to electrostatic discharge, which can cause internal damage and affect normal operation. Follow these guidelines when you handle this equipment:

- Touch a grounded object to discharge potential static.
  - Wear an approved grounding wriststrap.
  - Do not touch connectors or pins on component boards.
  - Do not touch circuit components inside the equipment.
  - Use a static-safe workstation, if available.
  - Store the equipment in appropriate static-safe packaging when not in use.
- 

## Special Conditions for Safe Use

---



**ATTENTION:**

- This product is grounded through the DIN rail to chassis ground. Use zinc plated chromate-passivated steel DIN rail to assure proper grounding. The use of other DIN rail materials (for example, aluminum or plastic) that can corrode, oxidize, or are poor conductors, can result in improper or intermittent grounding. Secure DIN rail to mounting surface approximately every 200 mm (7.8 in.) and use end-anchors appropriately. Be sure to ground the DIN rail properly. Refer to Industrial Automation Wiring and Grounding Guidelines, publication [1770-4.1](#), for more information.
  - Do not remove or replace an Adapter Module while power is applied. Interruption of the backplane can result in unintentional operation or machine motion.
  - Do not remove or replace a terminal base unit while power is applied. Interruption of the backplane can result in unintentional operation or machine motion.
  - If this equipment is used in a manner not specified by the manufacturer, the protection provided by the equipment may be impaired.
-



**WARNING:**

- When you insert or remove the module while backplane power is on, an electric arc can occur. This could cause an explosion in hazardous location installations.  
Be sure that power is removed or the area is nonhazardous before proceeding. Repeated electric arcing causes excessive wear to contacts on both the module and its mating connector. Worn contacts may create electrical resistance that can affect module operation.
  - If you insert or remove the module while backplane power is on, an electric arc can occur. This could cause an explosion in hazardous location installations.  
Be sure that power is removed or the area is nonhazardous before proceeding.
- 

**Electrical Safety Considerations**

---



**ATTENTION:**

- This equipment is certified for use only within the surrounding air temperature range of 0...55 °C (32...131 °F). The equipment must not be used outside of this range.
  - Use only a soft dry anti-static cloth to wipe down equipment. Do not use any cleaning agents.
- 



At the end of its life, this equipment should be collected separately from any unsorted municipal waste.

---

## Installing Your 220V AC Digital Input or Output Module

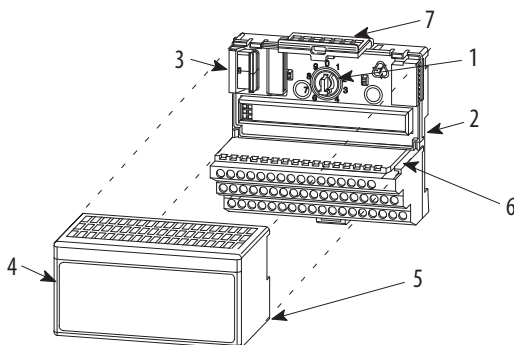

	Description		Description
1	Keyswitch	5	Alignment bar
2	Terminal base	6	Groove
3	Flexbus connector	7	Latching mechanism
4	Module		

The module mounts on a 1794 terminal base.



**ATTENTION:** During mounting of all devices, be sure that all debris (metal chips, wire strands, etc.) is kept from falling into the module. Debris that falls into the module could cause damage on power up.

1. Rotate the keyswitch (1) on the terminal base (2) clockwise to position [8](#) as required for this type of module.
2. Ensure that the Flexbus connector (3) is pushed all the way to the left to connect with the neighboring terminal base/adapter. **You cannot install the module unless the connector is fully extended.**
3. Make sure the pins on the bottom of the module are straight so they will align properly with the connector in the terminal base.

4. Position the module (4) with its alignment bar (5) aligned with the groove (6) on the terminal base.
5. Press firmly and evenly to seat the module in the terminal base unit. The module is seated when the latching mechanism (7) is locked into the module.

## Connecting Wiring for your 1794-IM8 and 1794-OM8 Module

1. Connect individual input or output wiring to numbered terminals on row (B) as indicated in the [Wiring Connections for 1794-IM8 and 1794-OM8](#) table.
2. **1794-IM8** – Connect the associated 220V AC L1 power lead of the input device to the corresponding odd-numbered terminal (C-1, 3, 5, 7, 9, 11, 13, or 15) on row (C) for each input as indicated in the [Wiring Connections for 1794-IM8 and 1794-OM8](#) table. (The 220V L1 power terminals of row (C) are internally connected together.)  
  
**1794-OM8** – Connect the associated 220V AC common L2 lead of the output device to the corresponding odd-numbered terminal (C-1, 3, 5, 7, 9, 11, 13, or 15) on row (C) as indicated in the [Wiring Connections for 1794-IM8 and 1794-OM8](#) table. (The 220V L2 commons of odd-numbered terminals on row (C) are internally connected together.)
3. Connect 220V AC power (L1) to terminal 34 on the row (C).
4. Connect 220V AC common (L2) to terminal 16 on the row (B).
5. If daisy chaining L1 power to the next terminal base, connect a jumper from terminal 51 (220V AC L1) on this base unit to terminal 34 on the next base unit.
6. If continuing 220V AC common (L2) to the next base unit, connect a jumper from terminal 33 (220V common L2) on this base unit to terminal 16 on the next base unit.



## Wiring Connections for 1794-IM8 and 1794-OM8

1794-IM8			1794-OM8		
Input <sup>(1)</sup>	1794-TBN		Output	1794-TBN, 1794-TBNF	
	Input Terminal	220V AC Supply		Output Terminal	Common
Input 0	B-0	C-1 <sup>(1)</sup>	Output 0	B-0	C-1 <sup>(2)</sup>
Input 1	B-2	C-3 <sup>(1)</sup>	Output 1	B-2	C-3 <sup>(2)</sup>
Input 2	B-4	C-5 <sup>(1)</sup>	Output 2	B-4	C-5 <sup>(2)</sup>
Input 3	B-6	C-7 <sup>(1)</sup>	Output 3	B-6	C-7 <sup>(2)</sup>
Input 4	B-8	C-9 <sup>(1)</sup>	Output 4	B-8	C-9 <sup>(2)</sup>
Input 5	B-10	C-11 <sup>(1)</sup>	Output 5	B-10	C-11 <sup>(2)</sup>
Input 6	B-12	C-13 <sup>(1)</sup>	Output 6	B-12	C-13 <sup>(2)</sup>
Input 7	B-14	C-15 <sup>(1)</sup>	Output 7	B-14	C-15 <sup>(2)</sup>
B = Even-numbered Input terminals 0...14, AC common terminals 16 and 33 C = Power terminals C-34 and C-51, and odd-numbered input terminals 1...15			B = Even-numbered Output terminals 0...14, AC common terminals 16 and 33 C = Power terminals C-34 and C-51, and odd- numbered terminals 1...15 on row C.		

(1) C-1, 3, 5, 7, 9, 11, 13, and 15 on the 1794-TBN are internally connected in the module to 220V AC L1.

(2) C-1, 3, 5, 7, 9, 11, 13, and 15 on the 1794-TBN are internally connected in the module to 220V AC common L2.

### 1794-TBN Terminal Base Wiring for 1794-IM8 and 1794-OM8

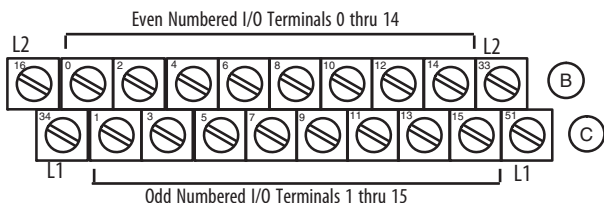

L1 = 220V AC power - Connect to terminal C-34

(1794-TBN shown)

L2 = 220V AC common - Connect to terminal B-16

Use B-33 and C-51 for daisy chaining to the next terminal base unit

## Configure Your AC Module

### Image Table Memory Map for the 1794-IM8 Module

Dec	15	14	13	12	11	10	9	8	7	6	5	4	3	2	1	0
Oct	17	16	15	14	13	12	11	10	7	6	5	4	3	2	1	0
Read	Not used – set to 0								17	16	15	14	13	12	11	10
Write	Not used – set to 0												Filter time FT			

Where I = Input status  
FT = Input filter time

### Image Table Memory Map for the 1794-OM8 Module

Dec	15	14	13	12	11	10	9	8	7	6	5	4	3	2	1	0
Oct	17	16	15	14	13	12	11	10	7	6	5	4	3	2	1	0
Read	Not used – set to 0															
Write	Not used – set to 0								07	06	05	04	03	02	01	00

Where 0 = Output

### Set the Input Filter Time for the 1794-IM8 Module

To select your input filter time (FT) for channels 00...07, set the corresponding bits in the output image table (complementary word) for the module.

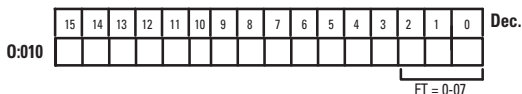

### Input Filter Time for the 1794-IM8 Module

Bits			Description	Selected Filter Time	Maximum Filter Time (ms)	
02	01	00	Filter Time for Inputs 00...07		Off to On	On to Off
0	0	0	Filter time 0 (default)	256 $\mu$ s	7.5	26.5
0	0	1	Filter time 1	512 $\mu$ s	8	27
0	1	0	Filter time 2	1 ms	9	28
0	1	1	Filter time 3	2 ms	10	29
1	0	1	Filter time 4	4 ms	12	31
1	0	1	Filter time 5	8 ms	16	35
1	1	0	Filter time 6	16 ms	24.5	44
1	1	1	Filter time 7	32 ms	42	60.5

For example, setting bits 00, 01, and 02 as shown below sets the off-to-on filter time for inputs 00...07 to 12 ms. For other settings, refer to the [Input Filter Time for the 1794-IM8 Module](#) table.

Write filter time on system startup.

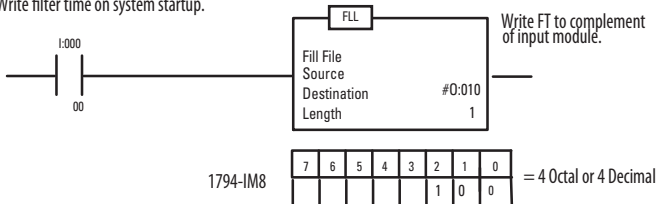

## Specifications

### Specifications – 220V AC Input Module 1794-IM8

Attribute	Value
Number of inputs	8, nonisolated
Recommended terminal base unit	1794-TBN, 1794-TBNK
Module mounting	See <a href="#">Derating Curve for 1794-IM8</a>
On-state voltage, min	159V AC
On-state voltage, nom	240V AC
On-state voltage, max	264V AC
On-state current, min	5.27 mA
On-state current, max	13.21 mA
Off-state voltage, max	40V AC
Off-state current, max	2.6 mA
Nominal input impedance	22.3 k $\Omega$
Nominal input current	12 mA @ 240V AC
Isolation voltage	250V (continuous), Basic Insulation Type, field side to backplane Type tested @ 1530V AC for 60 s No isolation between individual channels
Input filter time <sup>(1)</sup> Off to On On to Off	See <a href="#">Input Filter Time for the 1794-IM8 Module</a> table
Flexbus current	30 mA @ 5V DC
Power dissipation, max	4.7 W @ 264V AC
Thermal dissipation, max	16.2 BTU/hr @ 264V AC

- (1) Input off-to-on filter time is the time from a valid input signal to recognition by the module. Input on-to-off filter time is time from the input signal dropping below the valid level to recognition by the module.

**Specifications – 220V AC Output Module 1794-0M8**

Attribute	Value
Number of outputs	8, nonisolated
Recommended terminal base unit	1794-TBN, 1794-TBNF, 1794-TBNK, 1794-TBNFK
Module mounting	See <a href="#">Derating Curve for 1794-0M8</a>
Output voltage, min	159V AC
Output voltage, nom	240V AC
Output voltage, max	264V AC
Output current rating	4.0 A (8 outputs @ 500 mA)
On-state current, min	50 mA per output
On-state current, max	500 mA per output @ 55 °C
On-state voltage drop, max	1.5V AC @ 0.5 A
Surge current	7 A for 40 ms each, repeatable every 8 seconds
Off-state leakage, max	2.5 mA
Isolation voltage	250V (continuous), Basic Insulation Type, field side to backplane Type tested @ 1530V AC for 60 s No isolation between individual channels
Output signal delay <sup>(1)</sup> Off to On On to Off	1/2 cycle max 1/2 cycle max
Flexbus current	60 mA @ 5V DC
Power dissipation, max	5.0 W @ 0.5 A
Thermal dissipation, max	17.1 BTU/hr @ 0.5 A
Fusing (when using the 1794-TBNF) <sup>(2)</sup>	0.8 A, 250 slow-blow fuse (5 X 20 mm SAN-O MQ4-800 mA)

(1) Delay time is the time from the receipt of an output on or off command to the output actually turning on or off.

(2) Module outputs are not fused. We recommend that outputs be fused. If not using the 1794-TBNF, and fusing is desired, it must be provided externally.

**General Specifications**

Attribute	1794-IM8	1794-OM8
Terminal base screw torque	Determined by installed terminal base	
Dimensions, approx. (H x W x D)	94 x 94 x 69 mm (3.7 x 3.7 x 2.7 in.)	
Indicators (field side indication)	8 yellow status indicators (customer device driven)	8 yellow status indicators (logic driven)
External AC power supply voltage, nom	240V AC	
External AC power supply input frequency	47...63 Hz	
External AC power voltage range	159...264V AC (See <a href="#">Derating Curves</a> )	
North American temp code	T4	T4A
Keyswitch position	8	
Enclosure type rating	None (open-style)	
Weight, approx.	100 g (3.53 oz)	85 g (3.00 oz)
Wire size	Determined by installed terminal base	
Wiring category <sup>(1)</sup>	2 - on signal ports	

- (1) Use this Conductor Category information for planning conductor routing as described in the appropriate System Level Installation Manual. Also refer to Industrial Automation Wiring and Grounding Guidelines, publication [1770-4.1](#), for more information.

**Environmental Specifications**

Attribute	Value
Operating temperature	IEC 60068-2-1 (Test Ad, operating cold), IEC 60068-2-2 (Test Bd, operating dry heat), IEC 60068-2-14 (Test Nb, operating thermal shock): 0...55 °C (32...131 °F)
Storage temperature	IEC 60068-2-1 (Test Ab, unpackaged nonoperating cold), IEC 60068-2-2 (Test Bb, unpackaged nonoperating dry heat), IEC 60068-2-14 (Test Na, unpackaged nonoperating thermal shock): -40...85 °C (-40...185 °F)
Temperature, surrounding air, max	55 °C (131 °F)

**Environmental Specifications**

<b>Attribute</b>	<b>Value</b>
Relative humidity	IEC 60068-2-30 (Test Db, unpackaged damp heat): 5...95% noncondensing
Vibration	IEC60068-2-6 (Test Fc, operating): 5 g @ 10...500 Hz
Shock, operating	IEC60068-2-27 (Test Ea, unpackaged shock): 30 g
Shock, nonoperating	IEC60068-2-27 (Test Ea, unpackaged shock): 50 g
Emissions	IEC 61000-6-4
ESD immunity	IEC 61000-4-2: 6 kV contact discharges 8 kV air discharges
Radiated RF immunity	IEC 61000-4-3: 10V/m with 1 kHz sine-wave 80% AM from 80...2000 MHz 10V/m with 200 Hz 50% Pulse 100% AM @ 900 MHz 10V/m with 200 Hz 50% Pulse 100% AM @ 1890 MHz 1V/m with 1 kHz sine-wave 80% AM from 2000...2700 MHz
EFT/B immunity	IEC 61000-4-4: $\pm 2$ kV @ 5 kHz on power ports $\pm 2$ kV @ 5 kHz on signal ports
Surge transient immunity	IEC 61000-4-5: $\pm 1$ kV line-line(DM) and $\pm 2$ kV line-earth(CM) on signal ports
Conducted RF immunity	IEC 61000-4-6: 10V rms with 1 kHz sine-wave 80% AM from 150 kHz...80 MHz

## Certifications

Certifications (When Product is Marked) <sup>(1)</sup>	Value
c-UL-us	UL Listed Industrial Control Equipment, certified for US and Canada. See UL File E322657. UL Listed for Class I, Division 2 Group A,B,C,D Hazardous Locations, certified for U.S. and Canada. See UL File E334470.
CSA	CSA Certified Process Control Equipment. See CSA File LR93701. CSA Certified Process Control Equipment for Class I, Division 2 Group A,B,C,D Hazardous Locations. See CSA File LR93701.
CE	European Union 2014/30/EU EMC Directive, compliant with: <ul style="list-style-type: none"> <li>• EN 61326-1; Meas./Control/Lab., Industrial Requirements</li> <li>• EN 61000-6-4; Industrial Emissions</li> <li>• EN 61131-2; Programmable Controllers (Clause 8, Zone A &amp; B)</li> </ul> European Union 2014/35/EU LVD, compliant with: <ul style="list-style-type: none"> <li>• EN 61131-2; Programmable Controllers (Clause 11)</li> </ul> European Union 2011/65/EU RoHS, compliant with: <ul style="list-style-type: none"> <li>• EN 50581; Technical documentation</li> </ul>
KC	Korean Registration of Broadcasting and Communications Equipment, compliant with: <ul style="list-style-type: none"> <li>• Article 58-2 of Radio Waves Act, Clause 3</li> </ul>
EAC	<ul style="list-style-type: none"> <li>• Russian Customs Union TR CU 020/2011 EMC Technical Regulation</li> <li>• Russian Customs Union TR CU 004/2011 LV Technical Regulation</li> </ul>
RCM	Australian Radiocommunications Act, compliant with: <ul style="list-style-type: none"> <li>• EN 61000-6-4; Industrial Emissions</li> </ul>

(1) See the Product Certification link at <http://www.rockwellautomation.com/global/certification/overview.page> for Declaration of Conformity, Certificates, and other certification details.



## Derating Curves

### Derating Curve for 1794-IM8

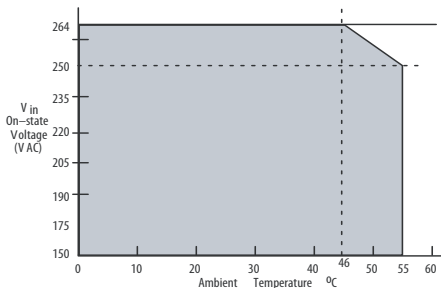

The area within the curve represents the safe operating range for the module under various conditions of user supplied 220V AC supply voltages and ambient temperatures.



 = All mounting positions (including normal horizontal, vertical, inverted horizontal) safe operating range

Voltage (maximum)	Temperature (maximum)
264	46
250	55

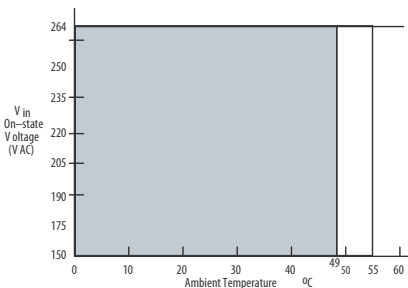
### Derating Curve for 1794-OM8



The area within the curve represents the safe operating range for the module under various conditions of user supplied 220V AC supply voltages and ambient temperatures.

 = Normal mounting safe operating range. Includes   
 = Other mounting positions (including inverted horizontal, vertical) safe operating range

Mounting	Temperature (maximum)
normal horizontal	55
Other mounting positions (including inverted horizontal, vertical)	49

**Notes:**

## Rockwell Automation Support

Use the following resources to access support information.

<b>Technical Support Center</b>	Knowledgebase Articles, How-to Videos, FAQs, Chat, User Forums, and Product Notification Updates.	<a href="http://www.rockwellautomation.com/knowledgebase">www.rockwellautomation.com/knowledgebase</a>
<b>Local Technical Support Phone Numbers</b>	Locate the phone number for your country.	<a href="http://www.rockwellautomation.com/global/support/get-support-now.page">www.rockwellautomation.com/global/support/get-support-now.page</a>
<b>Direct Dial Codes</b>	Find the Direct Dial Code for your product. Use the code to route your call directly to a technical support engineer.	<a href="http://www.rockwellautomation.com/global/support/direct-dial.page">www.rockwellautomation.com/global/support/direct-dial.page</a>
<b>Literature Library</b>	Installation Instructions, Manuals, Brochures, and Technical Data.	<a href="http://www.rockwellautomation.com/literature">www.rockwellautomation.com/literature</a>
<b>Product Compatibility and Download Center (PCDC)</b>	Get help determining how products interact, check features and capabilities, and find associated firmware.	<a href="http://www.rockwellautomation.com/global/support/pcdc.page">www.rockwellautomation.com/global/support/pcdc.page</a>

## Documentation Feedback

Your comments will help us serve your documentation needs better. If you have any suggestions on how to improve this document, complete the How Are We Doing? form at [http://literature.rockwellautomation.com/idc/groups/literature/documents/du/ra-du002\\_-en-e.pdf](http://literature.rockwellautomation.com/idc/groups/literature/documents/du/ra-du002_-en-e.pdf).

Rockwell Automation maintains current product environmental information on its website at <http://www.rockwellautomation.com/rockwellautomation/about-us/sustainability-ethics/product-environmental-compliance.page>.

Allen-Bradley, Rockwell Automation, FLEX I/O, Rockwell Software, and TechConnect are trademarks of Rockwell Automation, Inc. Trademarks not belonging to Rockwell Automation are property of their respective companies.

Rockwell Otomasyon Ticaret A.Ş., Kar Plaza İş Merkezi E Blok Kat:6 34752 İçerenköy, İstanbul, Tel: +90 (216) 5698400

[www.rockwellautomation.com](http://www.rockwellautomation.com)

**Power, Control and Information Solutions Headquarters**

Americas: Rockwell Automation, 1201 South Second Street, Milwaukee, WI 53204-2496 USA, Tel: (1) 414.382.2000, Fax: (1) 414.382.4444  
Europe/Middle East/Africa: Rockwell Automation NV, Pegasus Park, De Kleitlaan 12a, 1831 Diegem, Belgium, Tel: (32) 2 663 0600, Fax: (32) 2 663 0640  
Asia Pacific: Rockwell Automation, Level 14, Core F, Cyberport 3, 100 Cyberport Road, Hong Kong, Tel: (852) 2887 4788, Fax: (852) 2508 1846

**Publication 1794-IN104C-EN-P - July 2018**

Supersedes Publication 1794-IN104B-EN-P - July 2015

Copyright © 2018 Rockwell Automation, Inc. All rights reserved.