

# ControlLogix System

1756 Series Catalog Numbers

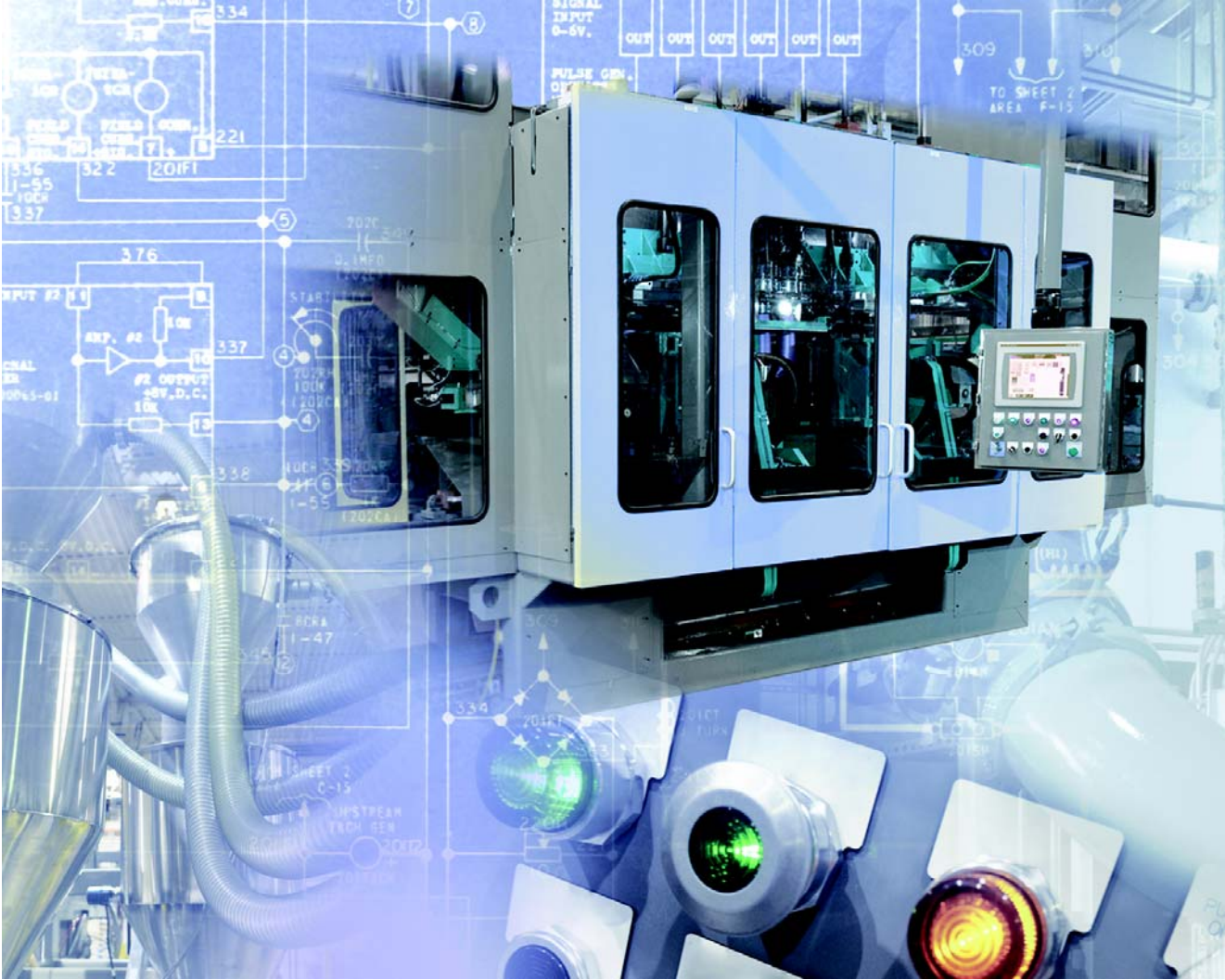

LISTEN.  
THINK.  
SOLVE.®

# Logix Controllers Comparison

Characteristic	ControlLogix® 1756-L81E, 1756-L82E, 1756-L83E, 1756-L84E, 1756-L85E	ControlLogix 1756-L71, 1756-L72, 1756-L73, 1756-L73XT, 1756-L74, 1756-L75  GuardLogix® 1756-L71S, 1756-L72S, 1756-L73S	Armor™ ControlLogix 1756-L72EROM  Armor™ GuardLogix® 1756-L72EROMS	CompactLogix™ 1769-L30ER, 1769-L30ER-NSE, 1769-L30ERM, 1769-L33ER, 1769-L33ERM, 1769-L36ERM  Compact GuardLogix 1769-L30ERMS, 1769-L33ERMS, 1769-L36ERMS	CompactLogix 1769-L24ER-BB1B, 1769-L24ER-QBFC1B, 1769-L27ERM-QBFC1B	CompactLogix 1769-L16ER-BB1B, 1769-L18ER-BB1B, 1769-L18ERM-BB1B, 1769-L19ER-BB1B
Controller tasks: • Continuous • Periodic • Event	• 32 • 1000 programs/task	• 32 • 100 programs/task (with V23 and earlier) • 1000 programs/task (with V24 and later)	• 32 • 100 programs/task (with V23 and earlier) • 1000 programs/task (with V24 and later)	• 32 • 100 programs/task	• 32 • 100 programs/task	• 32 • 100 programs/task
Event tasks	Consumed tag, EVENT instruction triggers, Module Input Data changes, and motion events	Consumed tag, EVENT instruction triggers, Module Input Data changes, and motion events	Consumed tag, EVENT instruction triggers, Module Input Data changes, and motion events	Consumed tag, EVENT instruction triggers and motion events	Consumed tag, EVENT instruction triggers and motion events	Consumed tag, EVENT instruction triggers and motion events
User memory	• 1756-L81E: 3 MB • 1756-L82E: 5 MB • 1756-L83E: 10 MB • 1756-L84E: 20 MB • 1756-L85E: 40 MB	• 1756-L71: 2 MB • 1756-L72: 4 MB • 1756-L73, 1756-L73XT: 8 MB • 1756-L74: 16 MB • 1756-L75: 32 MB • 1756-L71S: 2 MB + 1 MB safety • 1756-L72S: 4 MB + 2 MB safety • 1756-L73S: 8 MB + 4 MB safety	• 1756-L72EROM: 4 MB • 1756-L72EROMS: 4 MB + 2 MB safety	• 1769-L30ER, 1769-L30ER-NSE, 1769-L30ERM: 1 MB • 1769-L33ER, 1769-L33ERM: 2 MB • 1769-L36ERM: 3 MB • 1769-L30ERMS: 1 MB + 0.5 MB safety • 1769-L33ERMS: 2 MB + 1 MB safety • 1769-L36ERMS: 3 MB + 1.5 MB safety	• 1769-L24ER: 750 KB • 1769-L27ERM: 1 MB	• 1769-L16ER: 384 KB • 1769-L18ER, 1769-L18ERM: 512 KB • 1769-L19ER-BB1B: 1 MB
Built-in ports	• Single-port EtherNet/IP™ • 1 port USB client	1 port USB Client	• Dual-port EtherNet/IP • 1 port USB client	• Dual-port EtherNet/IP • 1 port USB Client	• Dual-port EtherNet/IP • 1 port USB Client	• Dual-port EtherNet/IP • 1 port USB Client
Communication options	• EtherNet/IP • ControlNet™ • DeviceNet™ • Data Highway Plus™ • Remote I/O • SynchLink™ • USB Client	• EtherNet/IP • ControlNet • DeviceNet • Data Highway Plus • Remote I/O • SynchLink • USB Client	• EtherNet/IP	• EtherNet/IP – Embedded switch – Single IP address • DeviceNet • USB Client	• EtherNet/IP – Embedded switch – Single IP address • DeviceNet • USB Client	• EtherNet/IP – Embedded switch – Single IP address • USB Client
Controller connections	N/A	500 connections	500 connections	256 connections	256 connections	256 connections
Network nodes	• 1756-L81E: 60 • 1756-L82E: 80 • 1756-L83E: 100 • 1756-L84E: 150 • 1756-L85E: 300	N/A	N/A	N/A	N/A	N/A
Controller redundancy	Future	Full support	None	Backup via DeviceNet	Backup via DeviceNet	None
Integrated motion	EtherNet/IP	• EtherNet/IP • SERCOS • Analog	EtherNet/IP	EtherNet/IP	EtherNet/IP	EtherNet/IP
Conformal coating	Standard <sup>(1)</sup>	Standard <sup>(1)</sup>	Standard <sup>(1)</sup>	Custom <sup>(2)</sup>	Custom <sup>(2)</sup>	Custom <sup>(2)</sup>

(1) Available when you select the K version of the controller.

(2) Contact the Rockwell Automation specialty products group for availability.

# Select a ControlLogix System

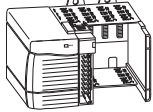

Step 1  
[ControlLogix I/O Modules](#)  
  
[Page 10](#)

- Select:
- I/O modules—Some modules have field-side diagnostics, electronic fusing, or individually isolated inputs/outputs
  - A remote terminal block (RTB) or wiring system for each I/O module

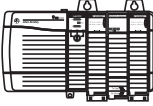

Step 2  
[ControlLogix Integrated Motion](#)  
  
[Page 18](#)

- Select:
- An EtherNet/IP communication module for Integrated Motion
  - Associated cables
  - Select drives, motors, and accessories (use the Motion Analyzer software)

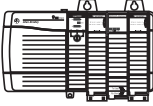

Step 3  
[ControlLogix Communication Modules](#)  
  
[Page 19](#)

- Select:
- Networks
  - Communication modules
  - Associated cables and network equipment
  - Sufficient modules and cables if you are planning a redundant system

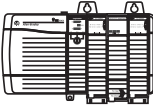

Step 4  
[ControlLogix Controllers](#)  
  
[Page 24](#)

- Select a controller:
- Standard ControlLogix controller
  - Redundant ControlLogix controller
  - Safety GuardLogix controller
  - Extreme environment ControlLogix controller
  - Standard Armor ControlLogix controller
  - Safety Armor GuardLogix controller

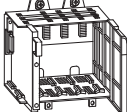
Step 5  
[ControlLogix Chassis](#)  
  
[Page 30](#)

- Select:
- A chassis with sufficient slots
  - Slot fillers for empty slots

Step 6  
[ControlLogix Power Supplies](#)  
  
[Page 31](#)

- Select:
- One power supply for each chassis, if you are using standard power supplies
  - A power supply bundle if you are planning a redundant power supply system

# ControlLogix System Overview

The ControlLogix system provides discrete, drives, motion, process, and safety control together with communication and state-of-the-art I/O in a small, cost-competitive package. The system is modular, so you can design, build, and modify it efficiently with significant savings in training and engineering.

## Example Configuration—ControlLogix System

A simple ControlLogix system consists of a standalone controller and I/O modules in one chassis. For a more comprehensive system, use the following:

- Multiple controllers in one chassis
- Multiple controllers joined across networks
- I/O in multiple platforms that are distributed in many locations and connected over multiple I/O links

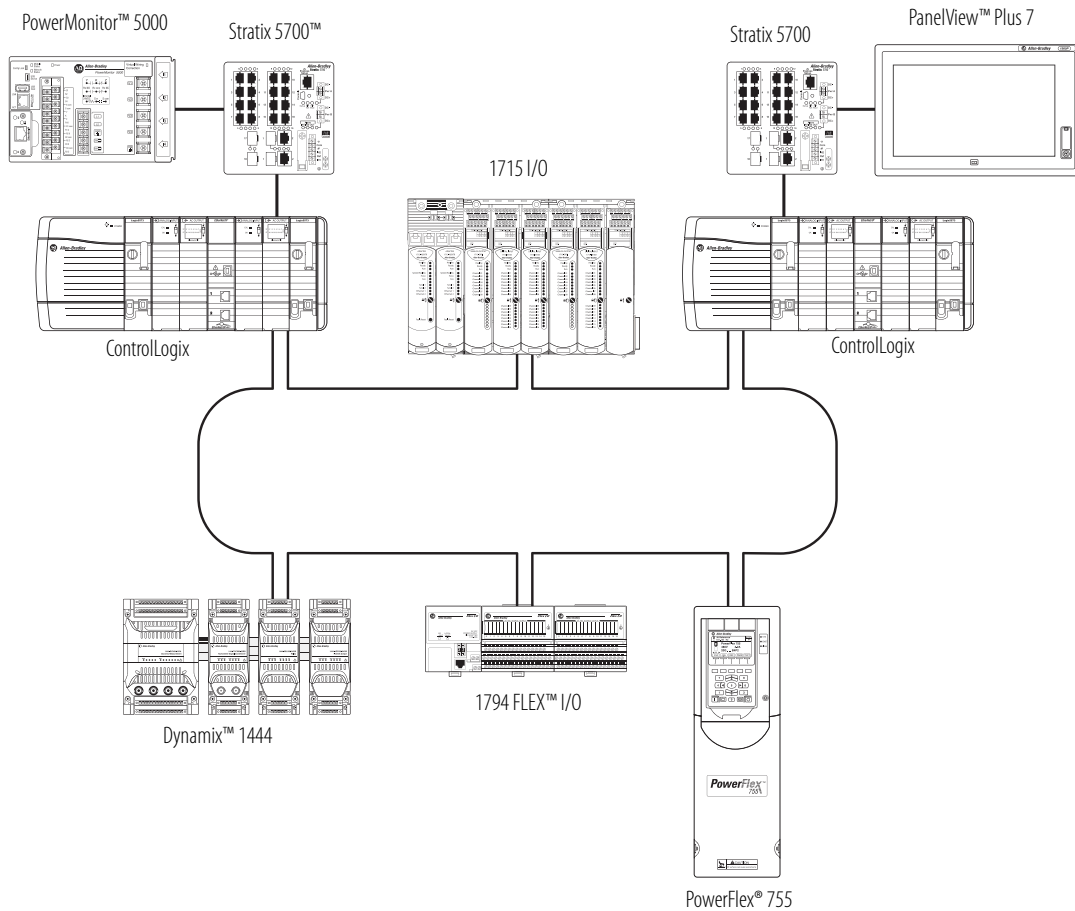

## Conformal Coating

A conformal coating solution is offered on select ControlLogix products. Conformal coating helps protect the assembly by providing a layer of protection against contaminants and humidity to extend product life in harsh, corrosive environments. Conformally coated products have a 'K' suffix at the end of the catalog number, such as 1756-A4K. Conformally coated, Allen-Bradley® products meet or exceed these requirements:

- ANSI/ISA 71.04.2013 G3 Environment (10-year exposure)
- IEC 61086-3-1 Class 2
- IPC-CC-830
- MIL-I-46058C
- EN600068-2-52 salt mist test, severity level 3

The most current list of conformally coated products can be found by contacting your local Rockwell Automation distributor, sales office, or at the following location:

<http://www.ab.com/en/epub/catalogs/12762/2181376/2416247/360807/ControlLogix-System.html>

## ControlLogix-XT System

ControlLogix-XT™ (Extended Temperature) controllers function the same way as traditional ControlLogix controllers with an extended temperature range. The ControlLogix-XT products include control and communication system components that are conformally coated to extend product life in harsh, corrosive environments:

- The standard ControlLogix system can withstand temperature ranges from 0...60 °C (33...140 °F).
- When used independently, the ControlLogix-XT system can withstand temperature ranges from -25...70 °C (-13...158 °F).



## Example Configuration—Redundant I/O System

The 1715 redundant I/O system lets a 1756-L7 ControlLogix controller communicate to a remote, redundant I/O chassis over an EtherNet/IP network. The 1715 redundant I/O system provides fault tolerance and redundancy for critical processes by using a redundant adapter pair and redundant I/O module pairs.

The redundant I/O system must be connected to a 1756-L7 ControlLogix system via an EtherNet/IP network. All connections are established via the Ethernet network by using the topologies that the 1756-EN2TR communication bridge supports.

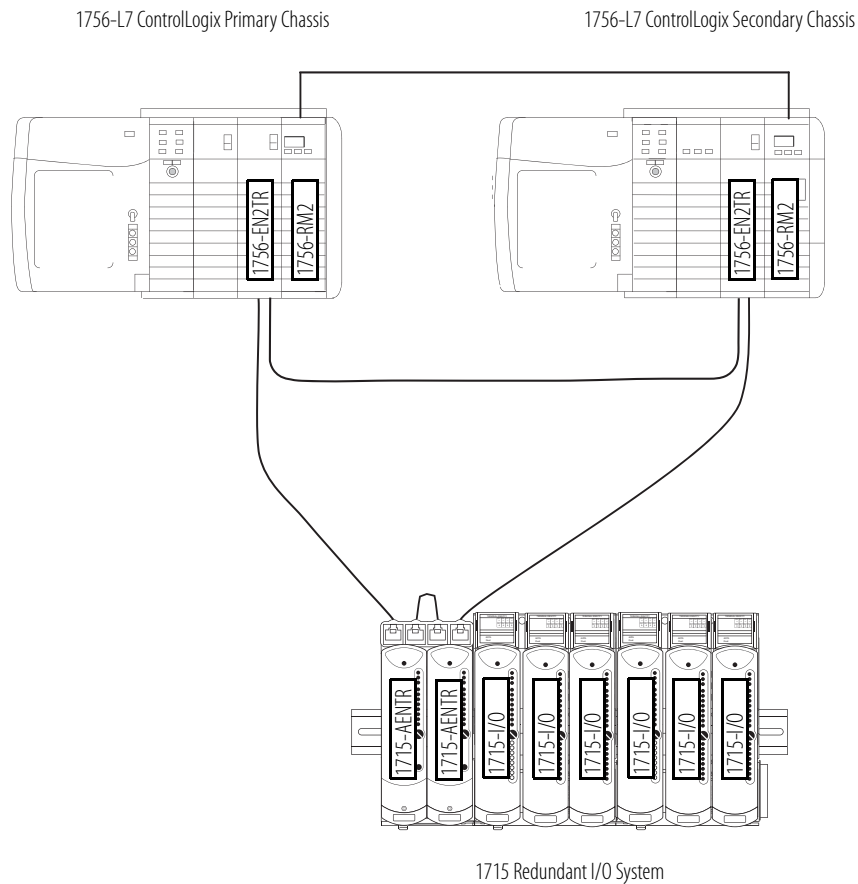

For detailed specifications, see the 1715 Redundant I/O System Specifications Technical Data, publication [1715-TD001](#).

## GuardLogix Safety System

A GuardLogix controller is a ControlLogix controller that also provides safety control. The GuardLogix system is a dual controller solution—you must use a GuardLogix controller with the appropriate safety partner to achieve SIL 3/PLe/Cat. 4. A major benefit of this system is that it is still one project, safety, and standard together. The safety partner controller is a part of the system, is automatically configured, and requires no user setup.

Application	Description
Up to and including SIL 3	<p>The GuardLogix controller system is type-approved and certified for use in safety applications up to and including SIL 3, according to IEC 61508, and applications up to and including category (PLe/Cat. 4), according to ISO 13849-1.</p> <p>For more information, see the following:</p> <ul style="list-style-type: none"> <li>GuardLogix 5570 Controllers User Manual, publication <a href="#">1756-UM022</a>, provides information on how to install, configure, and operate GuardLogix 5570 controllers in the Studio 5000 Automation Engineering &amp; Design Environment™ projects, version 21 or later.</li> <li>GuardLogix 5570 Controller System Safety Reference Manual, publication <a href="#">1756-RM099</a>, provides information on how to meet safety application requirements for GuardLogix 5570 controllers in Studio 5000® projects, version 21 or later.</li> <li>GuardLogix Controllers User Manual, publication <a href="#">1756-UM020</a>, provides information on how to install, configure, and operate GuardLogix 5560 and GuardLogix 5570 controllers in RSLogix 5000® projects, version 20 or earlier.</li> <li>GuardLogix Controller Systems Safety Reference Manual, publication <a href="#">1756-RM093</a>, provides information on how to meet safety application requirements for GuardLogix 5560 and GuardLogix 5570 controllers in RSLogix 5000 projects, version 20 or earlier.</li> <li>GuardLogix Safety Application Instruction Set Safety Reference Manual, publication <a href="#">1756-RM095</a>, provides programmers with details about the GuardLogix safety application instruction set.</li> </ul>
SIL 2	<p>Components of the ControlLogix system are type-approved and certified for use in SIL 2 applications, according to IEC 61508.</p> <p>For a list of ControlLogix system components that meet SIL 2 requirements, see the Using ControlLogix in SIL 2 Applications Safety Reference Manual, publication <a href="#">1756-RM001</a>.</p>

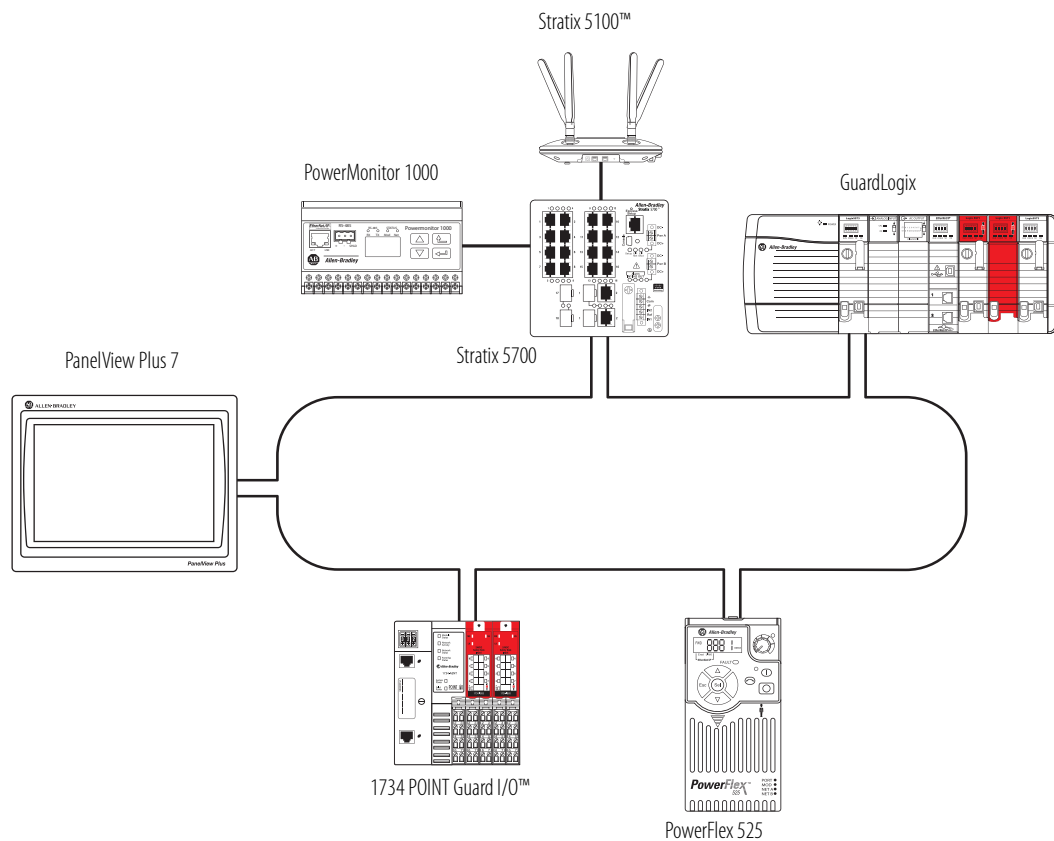



## Armor ControlLogix and Armor GuardLogix Systems

On-Machine™ standard and safety controllers support the same temperature range of ControlLogix, while offering global certifications and ratings and Ingress Protection (IP67) for dust and wash-down protection for immersion between 15 cm...1 m (5.91...393.70 in.) in harsher environments.

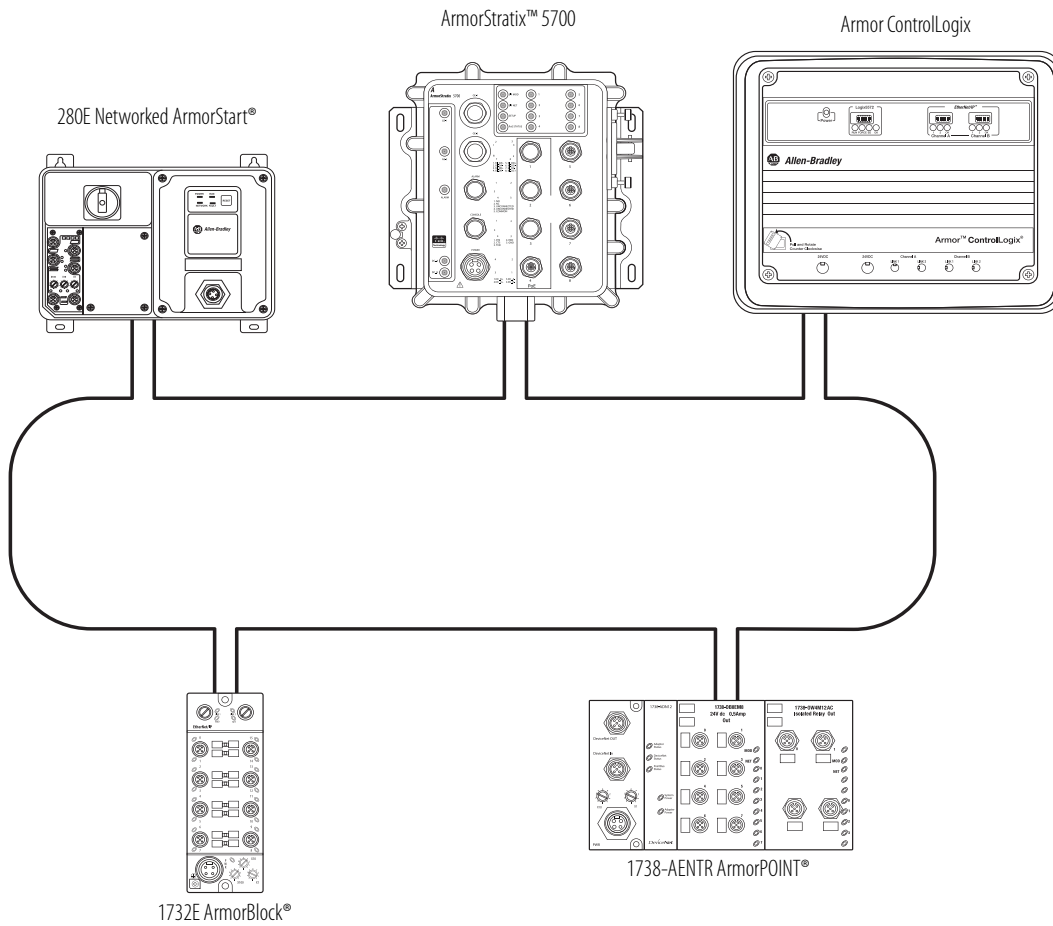

# ControlLogix I/O Modules

The ControlLogix architecture provides a wide range of input and output modules to span many applications, from high-speed digital to process control. The ControlLogix architecture uses a Producer/Consumer model so that input information and output status can be shared among multiple controllers.

Each ControlLogix I/O module mounts in a ControlLogix chassis and **requires** a removable terminal block (RTB) or a 1492 interface module (IFM) to connect all field-side wiring. RTBs and IFMs are not included with the I/O modules. They must be ordered separately.

For detailed specifications, see 1756 ControlLogix I/O Modules Specifications Technical Data, publication [1756-TD002](#).

## AC Digital Input Modules

Cat. No.	Inputs/Outputs	Voltage Category	Operating Voltage Range	Removable Terminal Block
1756-IA8D	8 diagnostic inputs (4 points/group)	120V AC	79...132V AC	1756-TBNH 1756-TBSH
1756-IA16	16 inputs (8 points/group)	120V AC	74...132V AC	1756-TBNH 1756-TBSH
1756-IA16I	16 individually isolated inputs	120V AC	74...132V AC	1756-TBCH 1756-TBS6H
1756-IA32	32 inputs (16 points/group)	120V AC	74...132V AC	1756-TBCH 1756-TBS6H
1756-IM16I	16 individually isolated inputs	240V AC	159...265V AC	1756-TBCH 1756-TBS6H
1756-IN16	16 inputs (8 points/group)	24V AC	10...30V AC	1756-TBNH 1756-TBSH

## AC Digital Output Modules

Cat. No.	Inputs/Outputs	Voltage Category	Operating Voltage Range	Removable Terminal Block
1756-OA8	8 outputs (4 points/group)	120/240V AC	79...265V AC	1756-TBNH 1756-TBSH
1756-OA8D	8 diagnostic, electronically fused outputs (4 points/group)	120V AC	74...132V AC	1756-TBNH 1756-TBSH
1756-OA8E	8 electronically fused outputs (4 points/group)	120V AC	74...132V AC	1756-TBNH 1756-TBSH
1756-OA16	16 mechanically fused/group outputs (8 points/group)	120/240V AC	74...265V AC	1756-TBNH 1756-TBSH
1756-OA16I	16 individually isolated outputs	120/240V AC	74...265V AC	1756-TBCH 1756-TBS6H
1756-ON8	8 outputs (4 points/group)	24V AC	10...30V AC, current > 50 mA 16...30V AC, current < 50 mA	1756-TBNH 1756-TBSH

## DC Digital Input Modules

Cat. No.	Inputs/Outputs	Voltage Category	Operating Voltage Range	Removable Terminal Block
1756-IB16	16 inputs (8 points/group)	12/24V DC sink	10...31.2V DC	1756-TBNH 1756-TBSH
1756-IB16D	16 diagnostic inputs (4 points/group)	12/24V DC sink	10...30V DC	1756-TBCH 1756-TBS6H
1756-IB16I	16 individually isolated inputs	12/24V DC sink/source	10...30V DC	1756-TBCH 1756-TBS6H
1756-IB16IF	16 high-speed, individually isolated inputs	12/24V DC sink/source	10...30V DC	1756-TBCH 1756-TBS6H
1756-IB16ISOE	16 individually isolated, sequence of events inputs	24/48V DC sink/source	10...55V DC	1756-TBCH 1756-TBS6H
1756-IB32	32 inputs (16 points/group)	12/24V DC sink	10...31.2V DC	1756-TBCH 1756-TBS6H
1756-IC16	16 inputs (8 points/group)	48V DC sink	30...55V DC @ 60 °C (140 °F) 30...60V DC @ 55 °C (131 °F)	1756-TBNH 1756-TBSH
1756-IG16	16 inputs (8 points/group)	5V DC TTL source (Low = True)	4.5...5.5V DC	1756-TBNH 1756-TBSH
1756-IH16I	16 individually isolated inputs	125V DC sink/source	90...146V DC	1756-TBCH 1756-TBS6H
1756-IH16ISOE	16 individually isolated, sequence of events inputs	125V DC sink/source	90...140V DC	1756-TBCH 1756-TBS6H
1756-IV16	16 inputs (8 points/group)	12/24V DC source	10...30V DC	1756-TBNH 1756-TBSH
1756-IV32	32 inputs (16 points/group)	12/24V DC source	10...30V DC	1756-TBCH 1756-TBS6H

## DC Digital Output Modules

Cat. No.	Inputs/Outputs	Voltage Category	Operating Voltage Range	Removable Terminal Block
1756-OB8	8 outputs	12/24V DC source	10...30V DC	1756-TBNH 1756-TBSH
1756-OB8EI	8 electronically fused, individually isolated outputs	12/24V DC source	10...30V DC	1756-TBCH 1756-TBS6H
1756-OB8I	8 individually isolated outputs	12/24V DC source	10...30V DC	1756-TBCH 1756-TBS6H
1756-OB16D	16 diagnostic outputs (8 points/group)	24V DC source	19.2...30V DC	1756-TBCH 1756-TBS6H
1756-OB16E	16 electronically fused outputs (8 points/group)	12/24V DC source	10...31.2V DC	1756-TBNH 1756-TBSH
1756-OB16I	16 individually isolated outputs	12/24V DC sink/source	10...30V DC	1756-TBCH 1756-TBS6H
1756-OB16IEF	16 high-speed, individually isolated, electronically-fused outputs	24V DC sink/source	10...30V DC	1756-TBCH 1756-TBS6H
1756-OB16IEFS	16 scheduled, high-speed, individually isolated, electronically-fused outputs	24V DC sink/source	10...30V DC	1756-TBCH 1756-TBS6H
1756-OB16IS	16 individually isolated outputs 8 scheduled outputs	12/24V DC sink/source	10...30V DC	1756-TBCH 1756-TBS6H
1756-OB32	32 outputs (16 points/group)	12/24V DC source	10...31.2V DC	1756-TBCH 1756-TBS6H
1756-OC8	8 outputs (4 points/group)	48V DC source	30...60V DC	1756-TBNH 1756-TBSH
1756-OG16	16 (8 points/group)	5V DC TTL source (Low=True)	4.5...5.5V DC	1756-TBNH 1756-TBSH
1756-OH8I	8 individually isolated outputs	120V DC	90...146V DC	1756-TBCH 1756-TBS6H
1756-OV16E	16 electronically fused outputs (8 points/group)	12/24V DC sink	10...30V DC	1756-TBNH 1756-TBSH
1756-OV32E	32 electronically fused outputs (16 points/group)	12/24V DC sink	10...30V DC	1756-TBCH 1756-TBS6H

## Contact Output Modules

Cat. No.	Inputs/Outputs	Operating Voltage Range	Removable Terminal Block
1756-OW16I	16 normally open, individually isolated outputs	5...125V DC 10...240V AC	1756-TBCH 1756-TBS6H
1756-OX8I	8 normally open 8 normally closed, individually isolated outputs (2 points/group)	5...125V DC 10...240V AC	1756-TBCH 1756-TBS6H

## Analog Input Modules

Cat. No.	Inputs/Outputs	Range	Resolution	Removable Terminal Block
1756-IF6CIS	6 individually isolated inputs, current sourcing	0...20 mA (over-range indication when exceeded)	16 bits 0.34 $\mu$ A/bit	1756-TBNH 1756-TBSH
1756-IF6I	6 individually isolated inputs	$\pm$ 10.5V 0...10.5V 0...5.25V 0...21 mA	16 bits 10.5V: 343 $\mu$ V/bit 0...10.5V: 171 $\mu$ V/bit 0...5.25V: 86 $\mu$ V/bit 0...21 mA: 0.34 $\mu$ A/bit	1756-TBNH 1756-TBSH
1756-IF8	8 single-ended inputs 4 differential inputs 2 high-speed differential inputs	$\pm$ 10V 0...10V 0...5V 0...20 mA	$\pm$ 10.25V: 320 $\mu$ V/cnt (15 bits plus sign bipolar) 0...10.25V: 160 $\mu$ V/cnt (16 bits) 0...5.125V: 80 $\mu$ V/cnt (16 bits) 0...20.5 mA: 0.32 $\mu$ A/cnt (16 bits)	1756-TBCH 1756-TBS6H
1756-IF8H	8 differential voltage or current inputs, HART interface	$\pm$ 10V 0...5V 1...5V 0...10V 0...20 mA 4...20 mA	16...21 bits	1756-TBCH 1756-TBS6H
1756-IF8I	8 individually isolated inputs, current or voltage	$\pm$ 10V 0...10V 0...5V 0...20 mA	24 bits $\pm$ 10.5V (1.49 $\mu$ V/count) 0...10.5V (1.49 $\mu$ V/count) 0...5.25V (1.49 $\mu$ V/count) 0...21 mA (2.99 nA/count)	1756-TBCH 1756-TBS6H
1756-IF8IH	8 individually isolated current inputs	0...20 mA 4...20 mA	16...21 bits	1756-TBCH 1756-TBS6H
1756-IF16	16 single-ended inputs 8 differential or 4 differential (high speed) inputs	$\pm$ 10V 0...10V 0...5V 0...20 mA	16 bits 10.5V: 343 $\mu$ V/bit 0...10.5V: 171 $\mu$ V/bit 0...5.25V: 86 $\mu$ V/bit 0...21 mA: 0.34 $\mu$ A/bit	1756-TBCH 1756-TBS6H
1756-IF16H	16 differential current inputs, HART interface	0...20 mA 4...20 mA	16...21 bits	1756-TBCH 1756-TBS6H

## Analog RTD and Thermocouple Modules

Cat. No.	Inputs/Outputs	Range	Resolution	Removable Terminal Block
1756-IR6I	6 individually isolated RTD inputs	1...487 $\Omega$ 2...1000 $\Omega$ 4...2000 $\Omega$ 8...4000 $\Omega$	16 bits 1...487 $\Omega$ : 7.7 m $\Omega$ /bit 2...1000 $\Omega$ : 15 m $\Omega$ /bit 4...2000 $\Omega$ : 30 m $\Omega$ /bit 8...4020 $\Omega$ : 60 m $\Omega$ /bit	1756-TBNH 1756-TBSH
1756-IRT8I	8 individually isolated inputs, RTD or thermocouple inputs (2 CJC)	1...500 $\Omega$ 2...1000 $\Omega$ 4...2000 $\Omega$ 8...4000 $\Omega$ -100...100 mV	24 bits 0...510 $\Omega$ : 0.06 m $\Omega$ /count 0...1020 $\Omega$ : 0.12 m $\Omega$ /count 0...2040 $\Omega$ : 0.25 m $\Omega$ /count 0...4080 $\Omega$ : 0.50 m $\Omega$ /count -101...101 mV: 0.01 $\mu$ V/count	1756-TBCH 1756-TBS6H
1756-IR12	12 channels RTD mode	1...500 $\Omega$ 2...1000 $\Omega$ 4...2000 $\Omega$ 8...4000 $\Omega$	24 bits 0...510 $\Omega$ : 0.06 m $\Omega$ /count 0...1020 $\Omega$ : 0.12 m $\Omega$ /count 0...2040 $\Omega$ : 0.25 m $\Omega$ /count 0...4080 $\Omega$ : 0.50 m $\Omega$ /count	1756-TBCH 1756-TBS6H
1756-IT16	16 channels, thermocouple mode 2 CJC	-100...100 mV	24 bits -101...101 mV: 0.01 $\mu$ V/count	1756-TBCH 1756-TBS6H
1756-IT6I	6 individually isolated thermocouple inputs 1 CJC	-12...78 mV -12...30 mV	16 bits -12...78 mV: 1.4 $\mu$ V/bit -12...30 mV: 0.7 $\mu$ V/bit	1756-TBNH 1756-TBSH
1756-IT6I2	6 individually isolated thermocouple inputs 2 CJC	-12...78 mV (1.4 $\mu$ V per bit) -12...30 mV (0.7 $\mu$ V per bit)	16 bits -12...78 mV: 1.4 $\mu$ V/bit -12...30 mV: 0.7 $\mu$ V/bit	1756-TBNH 1756-TBSH

## Analog Output Modules

Cat. No.	Inputs/Outputs	Range	Resolution	Removable Terminal Block
1756-OF4	4 voltage or current outputs	$\pm$ 10V 0...20 mA	Voltage: 15 bits across 10.5V, 320 $\mu$ V/bit Current: 15 bits across 21 mA, 650 nA/bit	1756-TBNH 1756-TBSH
1756-OF6CI	6 individually isolated outputs, current	0...21 mA	13 bits across 21 mA (2.7 $\mu$ A)	1756-TBNH 1756-TBSH
1756-OF6VI	6 individually isolated outputs, voltage	$\pm$ 10.5V	14 bits across 21V (1.3 mV) (13 bits across 10.5V +sign bit)	1756-TBNH 1756-TBSH
1756-OF8	8 voltage or current outputs	$\pm$ 10V 0...20 mA	15 bits across 21 mA - 650 nA/bit 15 bits across 10.4V - 320 $\mu$ V/bit	1756-TBNH 1756-TBSH
1756-OF8H	8 voltage or current outputs, HART interface	$\pm$ 10V 0...20 mA 4...20 mA	15...16 bits	1756-TBNH 1756-TBSH
1756-OF8I	8 individually isolated outputs, current or voltage	$\pm$ 10V 0...10V 0...5V 0...20 mA	16 bit $\pm$ 10.5V (0.32 mV/count) 0...10.5V (0.16 mV/count) 0...5.25V (0.08 mV/count) 0...21 mA (0.32 $\mu$ A/count)	1756-TBCH 1756-TBS6H
1756-OF8IH	8 individually isolated current outputs	0...20 mA 4...20 mA	15 bits across 24 mA, 732 nA per bit	1756-TBCH 1756-TBS6H

## Analog Combination Input and Output Module

Cat. No.	Inputs/Outputs	Range	Resolution	Removable Terminal Block
1756-IF4FXOF2F	4 high-speed, submillisecond, differential inputs 2 high-speed voltage or current outputs	Input: ±10V 0...10V 0...5V 0...20 mA Output: ±10V 0...20 mA	Input: Approx 14 bits across ±10V DC (21V total) ±10V: 1.3 mV/bit, 14-bit effective 0...10.5V: 1.3 mV/bit, 13-bit effective 0...5.25V: 1.3 mV/bit, 12-bit effective Approx 12 bits across 21 mA 0...21 mA: 5.25 μA/bit Output: 13 bits across 21 mA = 2.8 μA/bit 14 bits across 21.8V = 1.3 mV/bit	1756-TBCH 1756-TBS6H

## Specialty I/O Modules

Cat. No.	Inputs/Outputs	Description	Removable Terminal Block
1756-CFM	4 inputs (2 per channel) 2 outputs, current sourcing	Configurable flowmeter module 2 Flowmeter (F) inputs used for all modes 2 Gate inputs used in Totalizer mode for prover/store count	1756-TBNH 1756-TBSH
1756-HSC	2 counters, each with 3 inputs (A, B, Z for gate/reset) 4 outputs (2 points/group)	High-speed counter module 5V operation: 4.5...5.5V DC 12/24V operation: 10...26.4V DC	1756-TBCH 1756-TBS6H
1756-LSC8XIB8I	8...24V DC counters 8 individually isolated, standard inputs, or counters	Low speed counter module 8...40 kHz 24V DC counters 8 individually isolated 12/24V DC low speed (max frequency 40 kHz) counters 8 individually isolated high-speed 12/24V DC sink/source standard or counter control inputs	1756-TBCH 1756-TBS6H
1756-PLS	Left section: 2 groups of 4 outputs and 4 inputs each Center section: resolver interface and I/O control Right section: 2 groups of 4 outputs and 4 inputs each	Programmable limit switch module	Requires 3 RTBs: 1756-TBNH or 1756-TBSH

# HART Smart Instrumentation

HART (Highway Addressable Remote Transducer) is an open protocol that is designed to connect analog devices. For HART connectivity, select products available from Rockwell Automation and our Encompass™ Partner.

## Typical HART Configuration

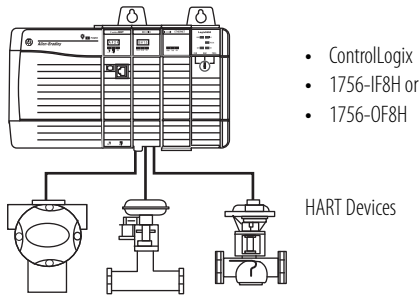

## HART Interfaces

If your application has	Select	Description
Analog and HART connectivity in one module No external hardware is required to access HART signal HART commands can be transmitted as unscheduled messages Supports asset management software to HART device	1756-IF8H 1756-IF16H 1756-OF8H	Rockwell Automation® analog I/O modules
Analog and HART connectivity in one module No external hardware is required to access HART signal HART commands can be transmitted as unscheduled messages Supports asset management software to HART device Provides current isolation	1756-IF8IH 1756-OF8IH	Rockwell Automation isolated analog I/O modules
Data acquisition or control application with slow update requirements (such as a tank farm) No external hardware is required to access HART signal Does not connect directly to asset management software	MVI56-HART	ProSoft interface
Analog and HART in one module Instrumentation in hazardous locations (FLEX Ex™ modules) HART commands can be transmitted as unscheduled messages Directly connects asset management software to HART devices	1794 FLEX I/O 1797 FLEX Ex I/O	There are FLEX I/O and FLEX Ex modules that are designed for HART systems. These catalog numbers end in an H, such as 1797-IE8H.



## Accessories—I/O Modules

### 1756 Removable Terminal Blocks

Removable terminal blocks (RTBs) provide a flexible interconnection between your plant wiring and 1756 I/O modules. The RTB plugs into the front of the I/O module. The type of module determines the RTB you need. You can choose screw-clamp or spring-clamp RTBs.

RTBs are not shipped with I/O modules. You must order them separately. The standard housing on the front of the wiring arm is not necessarily deep enough for 2.5 mm<sup>2</sup> (14 AWG) wiring. If you plan to use 2.5 mm<sup>2</sup> (14 AWG) wiring, also order the extended housing. For more information on Extended-Depth Housing, see Rockwell Automation Knowledgebase article #41488, Use of the 1756-TBE Extended Terminal Housing. You can access the article at: <https://rockwellautomation.custhelp.com/> (login is required).



Attribute	1756-TBNH	1756-TBSH	1756-TBCH	1756-TBS6H	1756-TBE
Description	20-position NEMA screw-clamp removable block	20-pin spring-clamp removable terminal block with standard housing	36-pin cage-clamp removable terminal block with standard housing	36-pin spring-clamp removable terminal block with standard housing	Extended-depth terminal block housing
Screw torque	0.8...1 N•m 7...9 lb•in		0.4 N•m 4.4 lb•in		—

### Wiring Systems

As an alternative to buying RTBs and connecting the wires yourself, you can buy a wiring system of the following:

- Interface modules (IFMs) that provide the I/O terminal blocks for Digital I/O modules. Use the prewired cables that match the I/O module to the IFM.
- Analog interface modules (AIFMs) that provide the I/O terminal blocks for analog I/O modules. Use the prewired cables that match the I/O module to the AIFM.
- I/O module-ready cables. One end of the cable assembly is an RTB that plugs into the front of the I/O module. The other end has individually color-coded conductors that connect to a standard terminal block.

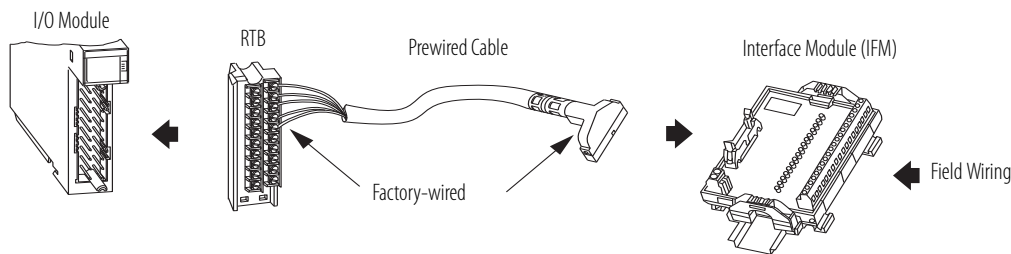

# ControlLogix Integrated Motion

The Logix architecture supports motion control components that work in a wide variety of machine architectures:

- Integrated Motion on the EtherNet/IP network supports a connection to Ethernet drives.
- The Kinetix® integrated-motion solution uses a SERCOS or EtherNet/IP interface to perform multi-axis, synchronized motion.
- Logix integrated motion supports the analog family of servo modules for controlling drives/actuators.
- Networked motion provides connection via the DeviceNet network to one axis drive to perform point-to-point indexing.

For detailed specifications on motion interface modules, see the 1756 ControlLogix Integrated Motion Modules Specifications Technical Data, publication [1756-TD004](#).

For more information, see these publications:

- Motion Analyzer CD to size your motion application and to make final component selection  
Download the software from <https://motionanalyzer.rockwellautomation.com/>
- Kinetix Motion Control Selection Guide, publication [GMC-SG001](#), to verify drive, motor, and accessory specifications

## Integrated Motion on an EtherNet/IP Network

Product	Consideration
Drive that supports EtherNet/IP connections	Unlimited velocity, torque, and VHz configured drives: <ul style="list-style-type: none"> <li>• Kinetix 6500 drives</li> <li>• Kinetix 5700 drives</li> <li>• Kinetix 5500 drives</li> <li>• Kinetix 350 drives</li> <li>• PowerFlex 755 drives</li> <li>• PowerFlex 527 drives</li> </ul>
ControlLogix controller	<ul style="list-style-type: none"> <li>• 1756-L7: as many as 100 drives per controller</li> <li>• 1756-L8: as many as 256 drives per controller</li> </ul>
ControlLogix EtherNet/IP communication module	<ul style="list-style-type: none"> <li>• 1...8 position loop axes that are configured with the 1756-EN2T or 1756-EN2TR modules</li> <li>• 1...128 position loop axes that are configured with the 1756-EN3TR module</li> </ul>

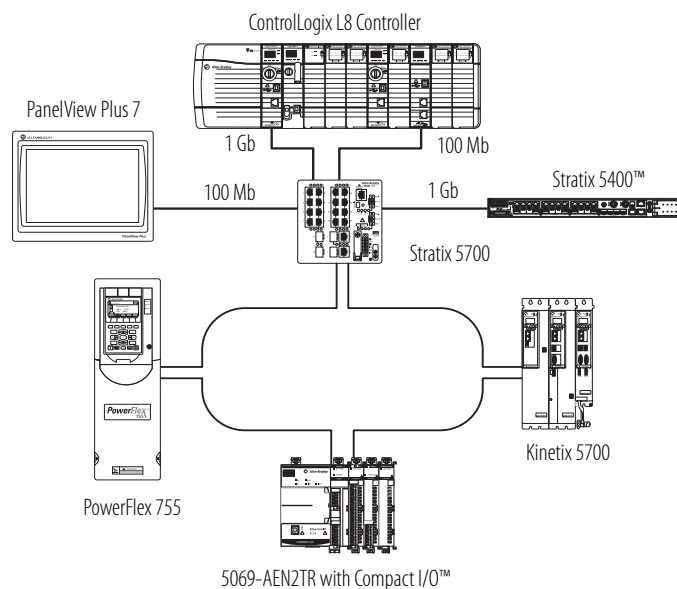

# ControlLogix Communication Modules

Separate communication modules are available for different networks. Install multiple communication modules into the ControlLogix backplane to bridge or route control and information data between different networks. You can route a message through a maximum of four chassis (eight communication hops). You do not need a ControlLogix controller in the chassis.

Application	Network	Page
<ul style="list-style-type: none"> <li>Plant management (material handling)</li> <li>Configuration, data collection, and control on one high-speed network</li> <li>Time-critical applications with no established schedule</li> <li>Inclusion of commercial technologies (such as video over IP)</li> <li>Internet/Intranet connection</li> <li>High-speed transfer of time-critical data between controllers and I/O devices</li> <li>Integrated Motion on the EtherNet/IP network and safety</li> <li>Redundant controller systems</li> </ul>	EtherNet/IP	19
<ul style="list-style-type: none"> <li>High-speed transfer of time-critical data between controllers and I/O devices</li> <li>Deterministic and repeatable data delivery</li> <li>Media redundancy</li> <li>Intrinsic safety</li> <li>Redundant controller systems</li> </ul>	ControlNet	20
<ul style="list-style-type: none"> <li>Connections of low-level devices directly to plant floor controllers, without interfacing them through I/O modules</li> <li>Data sent as needed</li> <li>More diagnostics for improved data collection and fault detection</li> <li>Less wiring and reduced start-up time than a traditional, hard-wired system</li> </ul>	DeviceNet	20
<ul style="list-style-type: none"> <li>Plant-wide and cell-level data sharing with program maintenance</li> <li>Data sent regularly</li> <li>Transfer of information between controllers</li> </ul>	Data Highway Plus	21
<ul style="list-style-type: none"> <li>Connections between controllers and I/O adapters</li> <li>Data sent regularly</li> <li>Distributed control so that each controller has its own I/O and communicates with a supervisory controller</li> </ul>	Remote I/O	21
<ul style="list-style-type: none"> <li>Fieldbus transmitters and actuators</li> <li>Closed-loop control</li> <li>Process automation</li> </ul>	Foundation Fieldbus	22

For detailed specifications, see the 1756 ControlLogix Communication Modules Specifications Technical Data, publication [1756-TD003](#).

## EtherNet/IP Communication Modules

EtherNet/IP (Ethernet Industrial Protocol) is an open industrial-networking standard that supports real time I/O messaging and message exchange. The EtherNet/IP network uses off-the-shelf Ethernet communication chips and physical media.

Cat. No.	Description	Media	Communication Rate	Integrated Motion on the EtherNet/IP Network Axes, max	TCP/IP Connections	Logix Connections
1756-EN2F	EtherNet/IP bridge, fiber	Fiber	100 Mbps	8	128	256
1756-EN2T	EtherNet/IP bridge, copper	Copper	10/100 Mbps	8	128	256
1756-EN2TR	EtherNet/IP bridge, embedded switch, copper	Dual copper	10/100 Mbps	8	128	256
1756-EN3TR	EtherNet/IP bridge, embedded switch, copper	Dual copper	10/100 Mbps	128	128	256

## Select a ControlLogix System

Cat. No.	Description	Media	Communication Rate	Integrated Motion on the EtherNet/IP Network Axes, max	TCP/IP Connections	Logix Connections
1756-EN2TXT	ControlLogix-XT, extended temperature EtherNet/IP bridge, copper for extreme environments	Copper	10/100 Mbps	8	128	256
1756-EN2TRXT	ControlLogix-XT, extended temperature EtherNet/IP bridge, embedded switch, copper	Dual copper	10/100 Mbps	8	128	256
1756-EN2TSC	EtherNet/IP secure communication module	Copper	10/100 Mbps	—	128	256
1756-ENBT	EtherNet/IP bridge, copper	Copper	10/100 Mbps	—	64	128
1756-EWEB	Ethernet web server module	Copper	10/100 Mbps	—	64	128

## ControlNet Communication Modules

The ControlNet network combines the functionality of an I/O network and a peer-to-peer network, providing high-speed performance. The ControlNet network provides deterministic, repeatable transfers of critical control data.

Cat. No.	Description	Communication Rate	Logix Connections	Number of Nodes
1756-CN2	ControlNet bridge, standard media	5 Mbps	128 <sup>(1)</sup>	99
1756-CN2R	ControlNet bridge, redundant media	5 Mbps	128 <sup>(1)</sup>	99
1756-CNB	ControlNet bridge, standard media	5 Mbps	64 <sup>(2)</sup>	99
1756-CNBR	ControlNet bridge, redundant media	5 Mbps	64 <sup>(2)</sup>	99
1756-CN2RXT	ControlLogix-XT, extended temperature ControlNet bridge, redundant media	5 Mbps	128 <sup>(1)</sup>	99

(1) 128 connections are available for standard use. An extra three connections are reserved for redundant control.

(2) Recommend using only 40...48 Logix connections for I/O.

## DeviceNet Communication Module

The DeviceNet network provides connections between simple, industrial devices (such as sensors and actuators) and higher-level devices (such as controllers and computers).

Cat. No.	Description	Communication Rate	Number of Nodes
1756-DNB	DeviceNet bridge	125 Kbps (500 m max) 250 Kbps (250 m max) 500 Kbps (100 m max)	64

## Data Highway Plus and Remote I/O Communication Modules

The Data Highway Plus network supports messaging between devices. The remote I/O link connects to remote I/O chassis and other intelligent devices.

The 1756-DHRIO module supports messaging between devices on DH+™ networks. The remote I/O functionality enables the module to act as a scanner for transferring digital and block transfer data to and from remote I/O devices.

The 1756-RIO module can act as a scanner or adapter on a remote I/O network. The 1756-RIO transfers digital, block transfer, analog, and speciality data without message instructions.

Cat. No.	Description	Communication Rate	DH+ Connections	RIO Connections	Maximum Recommended Logix Connections
1756-DHRIO	Data Highway Plus/Remote I/O two-channel communication module	57.6 Kbps, 115.2 Kbps, 230.4 Kbps	32 DH+ messages per DH+ module	Remote I/O scanner only 32 logical rack connections per remote I/O channel 16 block transfer connections per remote I/O channel	32
1756-RIO	Remote I/O communication module	57.6 Kbps, 115.2 Kbps, 230.4 Kbps	—	Remote I/O scanner or adapter 32 physical racks (0...76), any combination of rack size and block transfers	10 scheduled I/O
1756-DHRIOXT	ControlLogix-XT, extended temperature Data Highway Plus/Remote I/O two-channel communication module	57.6 Kbps, 115.2 Kbps, 230.4 Kbps	32 DH+ messages per DH+ module	Remote I/O scanner only 32 logical rack connections per remote I/O channel 16 block transfer connections per remote I/O channel	32

## Accessories: DH+ and Remote I/O Networks

Cat. No.	Description	Specifications
1770-CD	Cable to connect communication module to DH+ network	Belden 9463 twinaxial
9300-RADKIT	Remote access dial-in kit	56 Kbps modem connection to devices on a DH+ network includes the following: <ul style="list-style-type: none"> <li>• Pre-configured modem</li> <li>• Communication module</li> <li>• DIN rail mounting hardware</li> <li>• Associated cables</li> </ul>

## FOUNDATION Fieldbus Linking Devices

The FOUNDATION Fieldbus protocol is a network that is designed for distributed control of process applications.

Cat. No.	Description	Communication Rate	Number of H1 Ports	Devices per H1 Link	Devices per Linking Device
1757-FFLD2	FOUNDATION Fieldbus bridge to an Ethernet network	FOUNDATION Fieldbus: 31.25 Kbps EtherNet/IP: 10/100 Mbps	2	16 (8 . . . 10 recommended)	32
1757-FFLD4			4		64
1757-FFLDC2	FOUNDATION Fieldbus bridge to a ControlNet network	FOUNDATION Fieldbus: 31.25 Kbps ControlNet: 5 Mbps	2	16 (8 . . . 10 recommended)	32
1757-FFLDC4			4		64

### Example Configuration—Bridge to EtherNet/IP Network

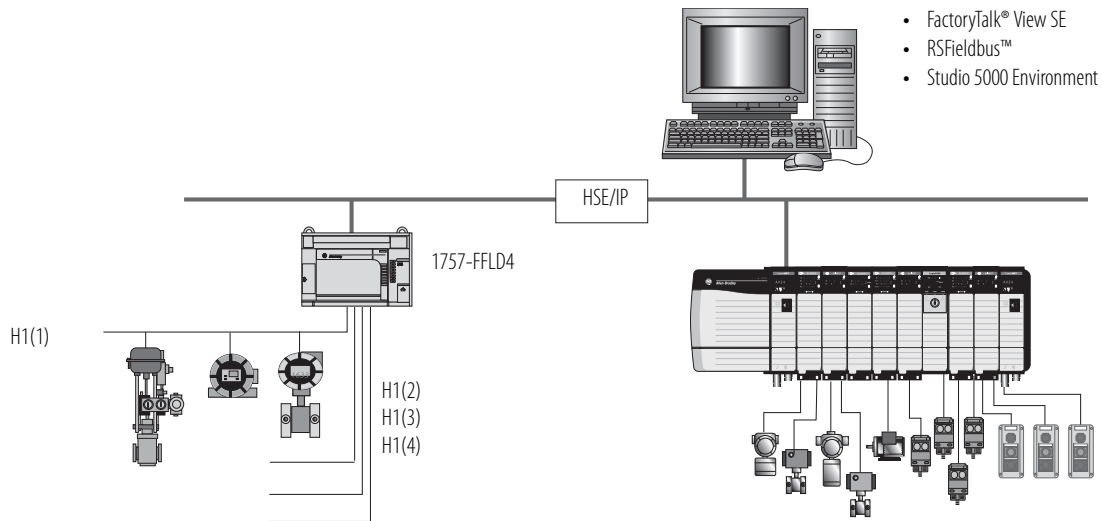

## Other Connectivity Options

Option	Consideration
USB connection	The ControlLogix controllers have a USB port in place of the serial port. <sup>(1)</sup> If your application requires RS-232 functionality, see the many Encompass Partners' products at <a href="http://www.rockwellautomation.com/encompass">http://www.rockwellautomation.com/encompass</a> .
DH-485 network	The controller serial port is compatible with DH-485 communication. The DH-485 connection does support remote programming and monitoring via the Logix Designer application. Or, add a 1756-DH485 communication module.
SynchLink™ network	The SynchLink communication module (1756-SYNCH) provides time synchronization and data broadcasting capabilities for distributed motion and coordinated drive control. The module connects a ControlLogix chassis to a SynchLink fiber-optic communication link.

(1) The USB port is intended only for temporary local programming purposes and not intended for permanent connection. Do not use the USB port in hazardous locations.

## Modbus Support

To access a Modbus TCP network, use one of the following methods:

- Connect through the 1756-EN2T, 1756-EN2TR, 1756-EN2F, or 1756-EN3TR modules, with firmware revision 5.007 or later and execute a ladder-logic routine.
- Connect through the 1756-EWEB module, with firmware revision 4.006 or later and execute a ladder-logic routine.

For more information, see Knowledgebase document 470365 at <http://www.rockwellautomation.com/knowledgebase/>.

To access a Modbus RTU network, connect through the serial port (if available) and execute a ladder-logic routine. For more information, see Using Logix5000™ Controllers as Masters or Slaves on Modbus Application Solution, publication [CIG-AP129](#).

# ControlLogix Controllers

The ControlLogix controller provides a scalable controller solution capable of addressing many I/O points.

The controller can be placed into any slot of a ControlLogix chassis and multiple controllers can be installed in the same chassis. Multiple controllers in the same chassis communicate with each other over the backplane (just as controllers can communicate over networks) but operate independently.

ControlLogix controllers can monitor and control I/O across the ControlLogix backplane, and over I/O links. ControlLogix controllers can communicate over EtherNet/IP, ControlNet, DeviceNet, DH+, Remote I/O, and RS-232-C (DF1/DH-485 protocol) networks and many third-party process and device networks. To provide communication for a ControlLogix controller, install the appropriate communication interface module into the chassis.

Cat. No.	Description	User Memory
1756-L81E	ControlLogix controller, 1 built-in USB port <sup>(1)</sup> , single port EtherNet/IP	3 MB
1756-L82E		5 MB
1756-L83E		10 MB
1756-L84E		20 MB
1756-L85E		40 MB
1756-L71	ControlLogix controller, 1 built-in USB port <sup>(1)</sup>	2 MB
1756-L72		4 MB
1756-L73		8 MB
1756-L74		16 MB
1756-L75		32 MB
1756-L73XT	ControlLogix-XT controller, extreme environment	8 MB
1756-L71S	GuardLogix safety controllers	2 MB standard 1 MB safety
1756-L72S		4 MB standard 2 MB safety
1756-L73S		8 MB standard 4 MB safety
1756-L7SP	GuardLogix safety partner (one is required for each GuardLogix L7 controller)	—
1756-L72EROM	Aarmor ControlLogix controllers, EtherNet/IP dual port	4 MB
1756-L72ERMOS	Aarmor GuardLogix controllers, EtherNet/IP dual port	4 MB standard 2 MB safety

(1) The USB port is intended only for temporary local programming purposes and not intended for permanent connection. Do not use the USB port in hazardous locations.

For detailed specifications, see the 1756 ControlLogix Controllers Technical Data, publication [1756-TD001](#).



## Standard ControlLogix Controllers

The ControlLogix controller is part of the Logix5000 family of controllers. A ControlLogix system includes the following:

- The ControlLogix controller, available in different combinations of user memory
- Studio 5000 environment
- 1756 ControlLogix I/O modules that reside in a 1756 chassis
- Separate communication modules for network communication



Feature	1756-L71, 1756-L72, 1756-L73, 1756-L74, 1756-L75	1756-L81E, 1756-L82E, 1756-L83E, 1756-L84E, 1756-L85E
Controller tasks	<ul style="list-style-type: none"> <li>• 32 tasks</li> <li>• 1000 programs/task<sup>(2)</sup></li> <li>• Event tasks: all event triggers</li> </ul>	<ul style="list-style-type: none"> <li>• 32 tasks</li> <li>• 1000 programs/task</li> <li>• Event tasks: all event triggers</li> </ul>
Built-in communication ports	1 port USB Client	<ul style="list-style-type: none"> <li>• 1 port USB client</li> <li>• Single-port EtherNet/IP</li> </ul>
Communication options	<ul style="list-style-type: none"> <li>• EtherNet/IP</li> <li>• ControlNet</li> <li>• DeviceNet</li> <li>• Data Highway Plus</li> <li>• Remote I/O</li> <li>• SynchLink</li> <li>• Third-party process and device networks</li> </ul>	<ul style="list-style-type: none"> <li>• EtherNet/IP</li> <li>• ControlNet</li> <li>• DeviceNet</li> <li>• Data Highway Plus</li> <li>• Remote I/O</li> <li>• SynchLink</li> <li>• Third-party process and device networks</li> </ul>
Controller device	500 connections	N/A
Node capacity	N/A	<ul style="list-style-type: none"> <li>• 1756-L81E: 60 EtherNet/IP nodes<sup>(3)</sup></li> <li>• 1756-L82E: 80 EtherNet/IP nodes<sup>(3)</sup></li> <li>• 1756-L83E: 100 EtherNet/IP nodes<sup>(3)</sup></li> <li>• 1756-L84E: 150 EtherNet/IP nodes<sup>(3)</sup></li> <li>• 1756-L85E: 300 EtherNet/IP nodes<sup>(3)</sup></li> </ul>
Network connections, per network module <sup>(1)</sup>	<ul style="list-style-type: none"> <li>• 256 EtherNet/IP; 128 TCP (1756-EN2x, 1756-ENxT(R))</li> <li>• 128 EtherNet/IP; 64 TCP (1756-ENBT)</li> <li>• 128 ControlNet (1756-CN2/B)</li> <li>• 100 ControlNet (1756-CN2/A)</li> <li>• 64 EtherNet/IP; 32 TCP (5069-AENTR)</li> <li>• 40 ControlNet (1756-CNB)</li> </ul>	N/A <sup>(4)</sup>
Controller redundancy	Full support	Future
Integrated motion	<ul style="list-style-type: none"> <li>• EtherNet/IP connection</li> <li>• SERCOS interface</li> <li>• Analog options (encoder input, LDT input, SSI input)</li> </ul>	<ul style="list-style-type: none"> <li>• EtherNet/IP connection</li> </ul>
Programming languages	<ul style="list-style-type: none"> <li>• Relay ladder</li> <li>• Structured text</li> <li>• Function block</li> <li>• Sequential function chart (SFC)</li> </ul>	<ul style="list-style-type: none"> <li>• Relay ladder</li> <li>• Structured text</li> <li>• Function block</li> <li>• Sequential function chart (SFC)</li> </ul>

(1) For the ControlLogix 5580 controllers, the total number of devices cannot exceed the total number of devices that the controller supports. The number of connections per network module shown is the maximum designed capacity of the modules. The device data size and requested data rate determines the actual device capacity.

(2) Studio 5000, version 23 and earlier, is limited to 100 Programs/Task.

(3) This value is the maximum number of EtherNet/IP nodes that the controller supports. Use the Integrated Architecture Builder design tool to lay out and validate your system design and additional node options. For further information on nodes on an EtherNet/IP network, see the ControlLogix 5580 Controllers User Manual, publication [1756-UM543](#).

(4) This value is determined by the node capacity for the ControlLogix 5580 controllers. See the node capacity feature for more information.

## ControlLogix-XT Controllers

The ControlLogix-XT controllers function in the same way as the traditional ControlLogix controllers, with an extended temperature range, and have the same features as the ControlLogix L7 controllers.

The ControlLogix-XT products include control and communication system components that are conformally coated to extend product life in harsh, corrosive environments:

- While the standard ControlLogix system can withstand temperatures from 0...60 °C (33...140 °F), the ControlLogix-XT system can withstand temperatures from -25...70 °C (-13...158 °F).



## Redundant ControlLogix Controllers

The ControlLogix controller supports controller redundancy. In a redundant controller system, you need these components:

- Two 1756 chassis each with the following the same:
  - Number of slots
  - Modules in the same slots
  - Redundancy firmware revisions in each module
  - Two additional ControlNet nodes<sup>(1)</sup> outside the redundant chassis pair.
- One 1756-RM2 or 1756-RM2XT module per chassis that supports the following:
  - One or two ControlLogix or ControlLogix-XT controllers of the same family
  - As many as seven ControlNet or EtherNet/IP communication modules in any combination
- One or two 1756-RMCx cables

For additional redundancy rules and restrictions, see the ControlLogix Enhanced Redundancy System User Manual, publication [1756-UM535](#).

(1) For a ControlNet I/O drop, two more ControlNet nodes are required outside the redundancy chassis pair. Not applicable with Ethernet I/O control.

## GuardLogix Controllers

A GuardLogix controller is a ControlLogix controller that also provides safety control.



Application	Description
SIL 1, 2, 3	<p>The GuardLogix controller system is type-approved and certified for use in safety applications up to and including SIL 3 according to IEC 61508, and applications up to and including PLe/Cat.4 according to ISO 13849-1. For more information, see the following:</p> <ul style="list-style-type: none"> <li>GuardLogix 5570 Controllers User Manual, publication <a href="#">1756-UM022</a>. Provides information on how to install, configure, and operate GuardLogix 5570 Controllers in Studio 5000, Version 21 or later projects.</li> <li>GuardLogix 5570 Controller Systems Safety Reference Manual, publication <a href="#">1756-RM099</a>. Provides information on how to meet safety application requirements for GuardLogix 5570 Controllers in Studio 5000, Version 21 or later projects.</li> </ul>

The GuardLogix system is a dual controller solution. You must use a primary controller and a safety partner to achieve SIL 3/PLe/Cat. 4.

Primary Controller	Safety Partner
1756-L71S, 1756-L72S, 1756-L73S	1756-L7SP
1756-L73SXT	1756-L7SPXT



During development, safety and standard have the same rules, multiple programmers, online editing, and forcing are all allowed. Once the project is tested and ready for final validation, you set the Safety Task to a SIL 3 integrity level, which the GuardLogix controller enforces. When safety memory is locked and protected, the safety logic cannot be modified and all safety functions operate with SIL 3 integrity. On the standard side of the GuardLogix controller, all functions operate like a regular Logix controller.

Use Guard I/O™ modules for field device connectivity on Ethernet or DeviceNet networks, and for safety interlocking between GuardLogix controllers use Ethernet or ControlNet networks. Multiple GuardLogix controllers can share safety data for zone to zone interlocking, or one GuardLogix controller can use remote distributed safety I/O between different cells/ areas.

The GuardLogix controller has the standard features of a ControlLogix controller and these safety-related features.

Feature	1756-LSP, 1756-L71S, 1756-L72S, 1756-L73S, 1756-L7SP, 1756-L73SXT, 1756-L7SPXT
Safety communication options	<p>Standard and safety</p> <ul style="list-style-type: none"> <li>EtherNet/IP</li> <li>ControlNet</li> <li>DeviceNet</li> </ul>
Network connections, per network module	<ul style="list-style-type: none"> <li>256 EtherNet/IP; 128 TCP (1756-EN2x, 1756-EN3x)</li> <li>128 EtherNet/IP; 64 TCP (1756-ENBT)</li> <li>128 ControlNet (1756-CN2/B, 1756-CN2R/B)</li> <li>64 DeviceNet (1756-DNB)</li> </ul>
Controller redundancy	Not supported
Safety Task Programming languages	Relay ladder

## Armor ControlLogix and Armor GuardLogix Controllers

The Armor ControlLogix controller, extends the standard ControlLogix platform to the On-Machine space. The Armor GuardLogix controller delivers safety control up to SIL 3, PLe, CAT 4.

Both controllers have the equivalent of two embedded 1756-EN3TR modules, which offer dual independent Ethernet ports that support a DLR network topology.

Feature	1756-L72EROM	1756-L72EROMS
Communication options	Standard <ul style="list-style-type: none"> <li>• EtherNet/IP</li> </ul>	Standard and safety <ul style="list-style-type: none"> <li>• EtherNet/IP</li> </ul>
Controller redundancy	Not supported	
Programming languages	<ul style="list-style-type: none"> <li>• Relay ladder</li> <li>• Structured Text</li> <li>• Function block</li> <li>• Sequential function chart</li> </ul>	<ul style="list-style-type: none"> <li>• Relay ladder</li> </ul>

## Accessories—Controllers

### Memory Cards

Memory cards offer nonvolatile memory to store a user program and tag data on a controller. The ControlLogix L7 and GuardLogix L7 controllers ship with 1784-SD1 Secure Digital (SD) card installed. The memory card installs in a socket on the controller. Through the Logix Designer application, you can manually trigger the controller to save to or load from nonvolatile memory or configure the controller to load from nonvolatile memory on powerup.

Attribute	1784-SD1	1784-SD2
Memory	1 GB	2 GB
Supported controllers	1756 ControlLogix L7 and 1756 GuardLogix L7	
Weight, approx	1.76 g (0.062 oz)	

### 1756 Energy Storage Modules

Important: Energy storage modules apply to only ControlLogix 5570 controllers.

Instead of a battery, the ControlLogix and GuardLogix controllers ship with a 1756-ESMCAP energy storage module (ESM) installed.

Cat No.	Description
1756-ESMCAP	Capacitor-based ESM included with the controller.
1756-ESMNSE	ESM without WallClockTime back-up power. Additionally, you can use this ESM only with a 1756-L73 (8 MB) or smaller memory-sized controller. Use this ESM if your application requires that the installed ESM deplete its residual energy to 40 $\mu$ l or less before transporting it into or out of your application.
1756-ESMNRM	ESM that secures the controller by permanently preventing the USB connection and SD card use. This ESM provides your application an enhanced degree of security.

The ControlLogix-XT extreme temperature controller ships with a 1756-ESMNCAPXT energy storage module installed.

Cat No.	Description
1756-ESMNCAPXT	Capacitor-based ESM included with the controller.
1756-ESMNSEXT	ESM without WallClockTime back-up power. Additionally, you can use this ESM only with a 1756-L73XT (8 MB) or smaller memory-sized controller. Use this ESM if your application requires that the installed ESM deplete its residual energy to 40 $\mu$ l or less before transporting it into or out of your application.
1756-ESMNRMXT	ESM that secures the controller by permanently preventing the USB connection and SD card use. This ESM provides your application an enhanced degree of security.

The 1756-L7SP safety partner for a GuardLogix system has the following modules available.

Cat No.	Description
1756-SPESMNSE	Capacitor-based ESM for a GuardLogix safety partner.
1756-SPESMNRM	ESM for a GuardLogix safety partner that secures the safety partner by permanently preventing the USB connection and SD card use.

# ControlLogix Chassis

The ControlLogix system is a modular system that requires a 1756 I/O chassis. Place any module into any slot. The backplane provides a high-speed communication path between modules.

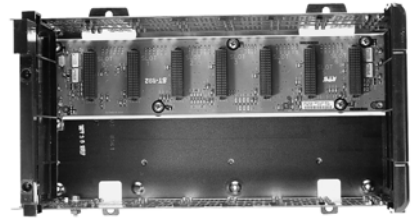

The chassis are designed for horizontal-only, back-panel mounting. The chassis are available in these options:

- Standard chassis
- ControlLogix-XT chassis

For detailed specifications, see the 1756 ControlLogix Chassis Specifications Technical Data, publication [1756-TD006](#).

## Standard Chassis

The chassis backplane provides a high-speed communication path between modules and distributes power to each of the modules within the chassis.

Cat. No.	Description	Slots
1756-A4	Standard chassis	4
1756-A7		7
1756-A10		10
1756-A13		13
1756-A17		17

## ControlLogix-XT Chassis

The ControlLogix-XT chassis support extreme temperature environments.

Cat. No.	Description	Slots	Temperature Range
1756-A7XT	ControlLogix-XT chassis	7	-25...70 °C (-13...158 °F)

## Accessories - Chassis

Use a slot filler module to fill empty slots.

Cat. No.	Description
1756-N2	Slot filler module for empty slots in standard ControlLogix chassis
1756-N2XT	Slot filler module for empty slots in ControlLogix-XT chassis

# ControlLogix Power Supplies

ControlLogix power supplies are used with the 1756 chassis to provide 1.2V, 3.3V, 5V, and 24V DC power directly to the chassis backplane. Select from these configurations:

- Standard power supplies
- ControlLogix-XT power supplies
- Redundant power supplies

For detailed specifications, see the 1756 ControlLogix Power Supplies Specifications Technical Data, publication [1756-TD005](#).



## Standard Power Supplies

You mount a standard power supply directly on the left end of the chassis, where it plugs directly into the backplane.

Cat. No.	Description	Voltage Category	Operating Voltage Range	Chassis
1756-PA72	Standard AC power supply	120V/220V AC	85...265V AC	Standard, series A, and series B
1756-PA75		120V/220V AC	85...265V AC	Standard, series B
1756-PB72	Standard DC power supply	24V DC	18...32V DC	Standard, series A, and series B
1756-PB75		24V DC	18...32V DC	Standard, series B
1756-PC75		48V DC	30...60V DC	Standard, series B
1756-PH75		125V DC	90...143V DC	Standard, series B

## ControlLogix-XT Power Supplies

The ControlLogix-XT power supplies support extreme temperature environments.

Cat. No.	Description	Voltage Category	Operating Voltage Range	Chassis
1756-PAXT	ControlLogix-XT AC power supply	85...265V AC	120/240V AC	XT
1756-PBXT	ControlLogix-XT DC power supply	24V DC	18...32V DC	XT

## Redundant Power Supplies

A redundant power supply system provides extra uptime protection for chassis that are used in critical applications. The redundant power supplies funnel power through the chassis adapter to the ControlLogix series B chassis backplane. To build a redundant power supply system, you need the following components.

Cat. No.	Amount	Description	Voltage Category	Operating Voltage Range	Chassis
1756-PAR2	Kit	Bundled system contains: <ul style="list-style-type: none"> <li>- Two 1756-PA75R power supplies</li> <li>- Two 1756-CPR2 cables</li> <li>- One 1756-PSCA2 chassis adapter</li> </ul>	110V AC	N/A	Standard, series B
1756-PAR2XT	Kit	Bundled system contains: <ul style="list-style-type: none"> <li>- Two 1756-PAXTR power supplies</li> <li>- Two 1756-CPR2 cables</li> <li>- One 1756-PSCA2 chassis adapter</li> </ul>	110V AC	N/A	
1756-PBR2	Kit	Bundled system contains: <ul style="list-style-type: none"> <li>- Two 1756-PB75R power supplies</li> <li>- Two 1756-CPR2 cables</li> <li>- One 1756-PSCA2 chassis adapter</li> </ul>	24V DC	N/A	
1756-PBR2XT	Kit	Bundled system contains: <ul style="list-style-type: none"> <li>- Two 1756-PBXTR power supplies</li> <li>- Two 1756-CPR2 cables</li> <li>- One 1756-PSCA2 chassis adapter</li> </ul>	24V DC	N/A	
1756-PA75R/A or 1756-PAXTR	2	Redundant AC power supply	120V/220V AC	85...256V AC	
1756-PB75R/A or 1756-PBXTR	2	Redundant DC power supply	24V DC	19.2...32V DC	
1756-CPR2 or 1756-CPR2D or 1756-CPR2U	2	Redundant power supply cable: Connector angle = straight, length = 0.91 m (3 ft) Connector angle = down, length = 0.91 m (3 ft) Connector angle = up, length = 0.91 m (3 ft)	N/A	N/A	
1756-PSCA2 or 1756-PSCA2XT	1	Redundant power supply chassis adapter			
N/A (user-supplied)	2	Annunciator wiring <sup>(1)</sup> (Maximum length = 10 m [32.8 ft])			

(1) Optional user-supplied annunciator wiring can be connected to the solid-state relay input for status and troubleshooting purposes.



Notes:

Notes:



# Rockwell Automation Support

Use the following resources to access support information.

<b>Technical Support Center</b>	Knowledgebase Articles, How-to Videos, FAQs, Chat, User Forums, and Product Notification Updates.	<a href="http://www.rockwellautomation.com/knowledgebase">www.rockwellautomation.com/knowledgebase</a>
<b>Local Technical Support Phone Numbers</b>	Locate the phone number for your country.	<a href="http://www.rockwellautomation.com/global/support/get-support-now.page">www.rockwellautomation.com/global/support/get-support-now.page</a>
<b>Direct Dial Codes</b>	Find the Direct Dial Code for your product. Use the code to route your call directly to a technical support engineer.	<a href="http://www.rockwellautomation.com/global/support/direct-dial.page">www.rockwellautomation.com/global/support/direct-dial.page</a>
<b>Literature Library</b>	Installation Instructions, Manuals, Brochures, and Technical Data.	<a href="http://www.rockwellautomation.com/literature">www.rockwellautomation.com/literature</a>
<b>Product Compatibility and Download Center (PCDC)</b>	Get help determining how products interact, check features and capabilities, and find associated firmware.	<a href="http://www.rockwellautomation.com/global/support/pcdc.page">www.rockwellautomation.com/global/support/pcdc.page</a>

## Documentation Feedback

Your comments will help us serve your documentation needs better. If you have any suggestions on how to improve this document, complete the How Are We Doing? form at [http://literature.rockwellautomation.com/idc/groups/literature/documents/du/ra-du002\\_-en-e.pdf](http://literature.rockwellautomation.com/idc/groups/literature/documents/du/ra-du002_-en-e.pdf).

Rockwell Automation maintains current product environmental information on its website at <http://www.rockwellautomation.com/rockwellautomation/about-us/sustainability-ethics/product-environmental-compliance.page>.

Allen-Bradley, Armor, ArmorBlock, Armor GuardLogix, ArmorPOINT, ArmorStart, ArmorStratix, CompactLogix, ControlLogix, ControlLogix-XT, Data Highway Plus, DH+, Dynamix, Encompass, FactoryTalk, FLEX Ex, FLEX I/O, Guard I/O, GuardLogix, Kinetix, LISTEN. THINK. SOLVE., Logix5000, On-Machine, PanelView, POINT Guard I/O, POINT I/O, PowerFlex, PowerMonitor, Rockwell Automation, Rockwell Software, RSFieldbus, RSLogix 5000, Stratix 5100, Stratix 5400, Stratix 5700, Studio 5000, Studio 5000 Automation Engineering & Design Environment, and SynchLink are trademarks of Rockwell Automation, Inc.

Trademarks not belonging to Rockwell Automation are property of their respective companies.

ControlNet, DeviceNet, and EtherNet/IP are trademarks of the ODVA.

**[www.rockwellautomation.com](http://www.rockwellautomation.com)**

### Power, Control and Information Solutions Headquarters

Americas: Rockwell Automation, 1201 South Second Street, Milwaukee, WI 53204-2496 USA, Tel: (1) 414.382.2000, Fax: (1) 414.382.4444

Europe/Middle East/Africa: Rockwell Automation NV, Pegasus Park, De Kleetlaan 12a, 1831 Diegem, Belgium, Tel: (32) 2 663 0600, Fax: (32) 2 663 0640

Asia Pacific: Rockwell Automation, Level 14, Core F, Cyberport 3, 100 Cyberport Road, Hong Kong, Tel: (852) 2887 4788, Fax: (852) 2508 1846

Publication 1756-SG001U-EN-P - February 2016

Supersedes Publication 1756-SG001T-EN-P - October 2015

Copyright © 2016 Rockwell Automation, Inc. All rights reserved. Printed in the U.S.A.