



System 57 5704F Control System

Helping to make a safer world

Ensure that you read and understand these instructions **BEFORE** operating the equipment.

Please pay particular attention to the Safety Warnings.



WARNINGS

The items of equipment covered by this manual are:

1. Not designed or certified for use in hazardous areas.
2. Designed for indoor use only.
3. Not to be exposed to rain or moisture.
4. Under fault conditions some electrical components on the Fire Control Card may get hot. Exercise care when removing this card from powered systems.

CAUTIONS

1. Use only approved parts and accessories with the System 57 Control System.
2. To maintain safety standards, regular maintenance, calibration and operation of the System 57 Control System by qualified personnel is essential.

IMPORTANT NOTICES

1. Honeywell Analytics can take no responsibility for installation and/or use of its equipment if this is not done in accordance with the appropriate issue and/or amendment of the manual.
2. The user of this manual should ensure that it is appropriate in all details to the exact equipment to be installed and/or operated. If in doubt, the user should contact Honeywell Analytics for advice.

Honeywell Analytics reserve the right to change or revise the information supplied in this document without notice and without obligation to notify any person or organisation of such revision or change.

If further details are required which do not appear in this manual, contact Honeywell Analytics or one of their agents.

MANUAL ISSUE STATUS

The following table indicates the issue status of this manual and of the individual chapters within the manual

ISSUE 01, MARCH 1999

Section	Pages	File	Issue
Front Pages	1 to 6	MAN0546A	01
Chapter 1	1-1 to 1-8	MAN0546B	01
Chapter 2	2-1 to 2-26	MAN0546C	01
Chapter 3	3-1 to 3-32	MAN0546D	01
Chapter 4	4-1 to 4-46	MAN0546E	01
Chapter 5	5-1 to 5-24	MAN0546F	01
Chapter 6	6-1 to 6-12	MAN0546G	01
Chapter 7	7-1 to 7-14	MAN0546H	01
Chapter 8	8-1 to 8-4	MAN0546I	01

Since the Front Pages of a manual contain the above manual issue status table these pages will always carry the overall issue status of the manual. The remaining chapter issues will reflect the latest issue of those chapters at the time of print of a manual. eg. Issue A, B, C, etc for chapters of provisional information and 1, 2, 3, etc for chapters of confirmed information.

HELP US TO HELP YOU

Every effort has been made to ensure the accuracy in the contents of our documents, however, Honeywell Analytics can assume no responsibility for any errors or omissions in our documents or their consequences.

Honeywell Analytics would greatly appreciate being informed of any errors or omissions that may be found in our documents. To this end we include the following form for you to photocopy, complete and return to us so that we may take the appropriate action.

HELP US TO HELP YOU

To: Honeywell Analytics Limited,
Hatch Pond House,
4 Stinsford Road,
Nuffield Estate,
POOLE. Dorset.
BH17 0RZ.
United Kingdom.

Tel : +44 (0) 1202 676161
Fax : +44 (0) 1202 678011
email : gasdetection@honeywell.com

From:
Address:

Tel :
Fax :
email :

I suggest the following corrections/changes be made to Chapter Section

Marked up copies attached (as appropriate): Yes / No

Please inform me of the outcome of this change: Yes / No

For Marketing Communications, Honeywell Analytics:

Actioned By: Date:

Response: Date:

MANUAL CONTENTS

Chapter

1. SYSTEM CONCEPT
2. SYSTEM DESCRIPTION
3. CONTROLS AND FACILITIES
4. INSTALLATION INSTRUCTIONS
5. COMMISSIONING AND MAINTENANCE INSTRUCTIONS
6. OPERATING INSTRUCTIONS
7. SPECIFICATION
8. ORDERING INFORMATION

USER NOTES

CHAPTER 1 - SYSTEM CONCEPT

5704F SERIES CONTROL SYSTEM CHAPTER 1 SYSTEM CONCEPT

CHAPTER 1 - SYSTEM CONCEPT

CONTENTS

Section	Page
1. PRINCIPAL FEATURES	1-3
2. CONSTRUCTION	1-5

FIGURES

Figure	Page
1. 5704 Control System	1-7
2. 5704 Control System Over View	1-8

CHAPTER 1 - SYSTEM CONCEPT

1. PRINCIPAL FEATURES

The 5704F Series Control System is part of the System 57 family and is designed to monitor field mounted industrial fire detectors. The principal features of the system are:

- Provides up to 60 loops of fire detection in a standard 19" sub-rack using a 3U format.
- Provides up to 28 loops of fire detection in a half 19" sub-rack using a 6U format.
- Racking available for both front and rear access field wiring.
- Fire and Gas cards can be freely mixed in the same rack.
- Simple field connections for wire up to 2.5mm² (14 AWG).
- Four loop inputs and two switched outputs per one inch wide card.
- Inputs compatible with flame, smoke and heat detectors, and manual call points.
- Fault monitoring on all fire inputs and switched output circuits.
- Configurable change-over relay output options per card.
- Electronic adjustment of all operating parameters.
- Cards removable without disturbing other wiring.
- Multi-alarm mode for master, zone and voted alarms.
- Remote acknowledge, reset and silence inputs per card.
- Easy to operate using dedicated Fire Status Panel.
- Earth leakage fault detection.
- EMC Compliant.

CHAPTER 1 - SYSTEM CONCEPT

To provide the additional specialised user controls and audible/visual indicators that are necessary for a fire control system one additional Common Fire Status Panel is required in every rack. The principal features of the common fire status panel are listed below:

- One 1" wide panel per rack.
- Connects to the system via any one of the fire control cards.
- Clear visual status display for:
 - common fire, fault, inhibit, silence, walk test and earth fault.
 - power.
- Audible sounder with distinctive operating modes for:
 - common fire.
 - other system conditions.
- User push-button controls for:
 - common: acknowledge, silence, reset and lamp test.
 - channel: inhibit, walk test.

CHAPTER 1 - SYSTEM CONCEPT

2. CONSTRUCTION

The system consists of individual 1" (2.54cm) wide cards fitted to a rigid custom rack designed to fit Euro rack cabinets. Two rack widths are available:

- a. 19 inch with 17 card slots to house up to 15 Four Channel Control Cards , one Fire Status Panel and an Engineering Card.
- b. Half 19 inch with nine card slots to house up to seven Four Channel Control Cards, one Fire Status Panel and an Engineering Card.

Each sub-rack contains an Engineering Card and a DC Input Card to make up the rack system

The system is designed to meet the differing customer wiring configurations and to achieve this the control functions are split away from the relays and field wiring connections. Four loops of fire detection therefore consists of:

- a. Four Channel Control Card

Each Four Channel Control Card functions independently and contains all the necessary electronic circuitry to provide the sensor drive, alarm detection and gas level display for four loops of fire detection.

- b. Hex Relay Interface Card

The Hex Relay Interface Card provides the interface connections between the Control Card and the respective field connected fire sensors. In addition, it provides six relay outputs via the field connections.

- c. Relay Interface Assembly

Where additional relay contacts are required, an Expansion Relay Card is attached to the Hex Relay Interface Card. The new assembly becomes the Hex Relay Interface Assembly and expands the relay outputs to 16. This combination occupies two interface card slots and as a consequence limits the number of control cards that can be fitted to the rack.

CHAPTER 1 - SYSTEM CONCEPT

In a system where the field wiring is required to be connected to the rear of the system, the rack is centrally divided into front and rear sections by a printed circuit board backplane which provides common signal routing between individual Four Channel Control Cards. The control cards are fitted at the front of the rack while Hex Relay Interface Cards are fitted directly behind the associated Four Channel Control Card at the rear of the rack. The control cards and their respective interface cards are interconnected by a plug and socket arrangement.

In a system where the field wiring is required to be connected to the front of a system, the Four Channel Control Cards and Hex Relay Interface Cards are mounted one above the other in a 6U rack. The backplane printed circuit board still provides the common signal routing between the individual Four Channel Control Cards, but short cables at the rear of the cards connect each control card to their respective Quad Relay Interface Card.

Simple operation and maintenance of the system is carried out using push buttons on the Fire Status Panel fitted in each rack. More complex configuration can be carried out using the RS232 link between the Engineering Card and an external IBM compatible personal computer running the engineering interface software.

When a Hex Relay Interface Assembly is used, the resultant four channel control assembly then takes up two card slots.

A mixture of 5704F, 5704 and 5701 Control Cards may be fitted in the same System 57 rack.

The 5704 Control System is shown in Figure 1.

CHAPTER 1 - SYSTEM CONCEPT

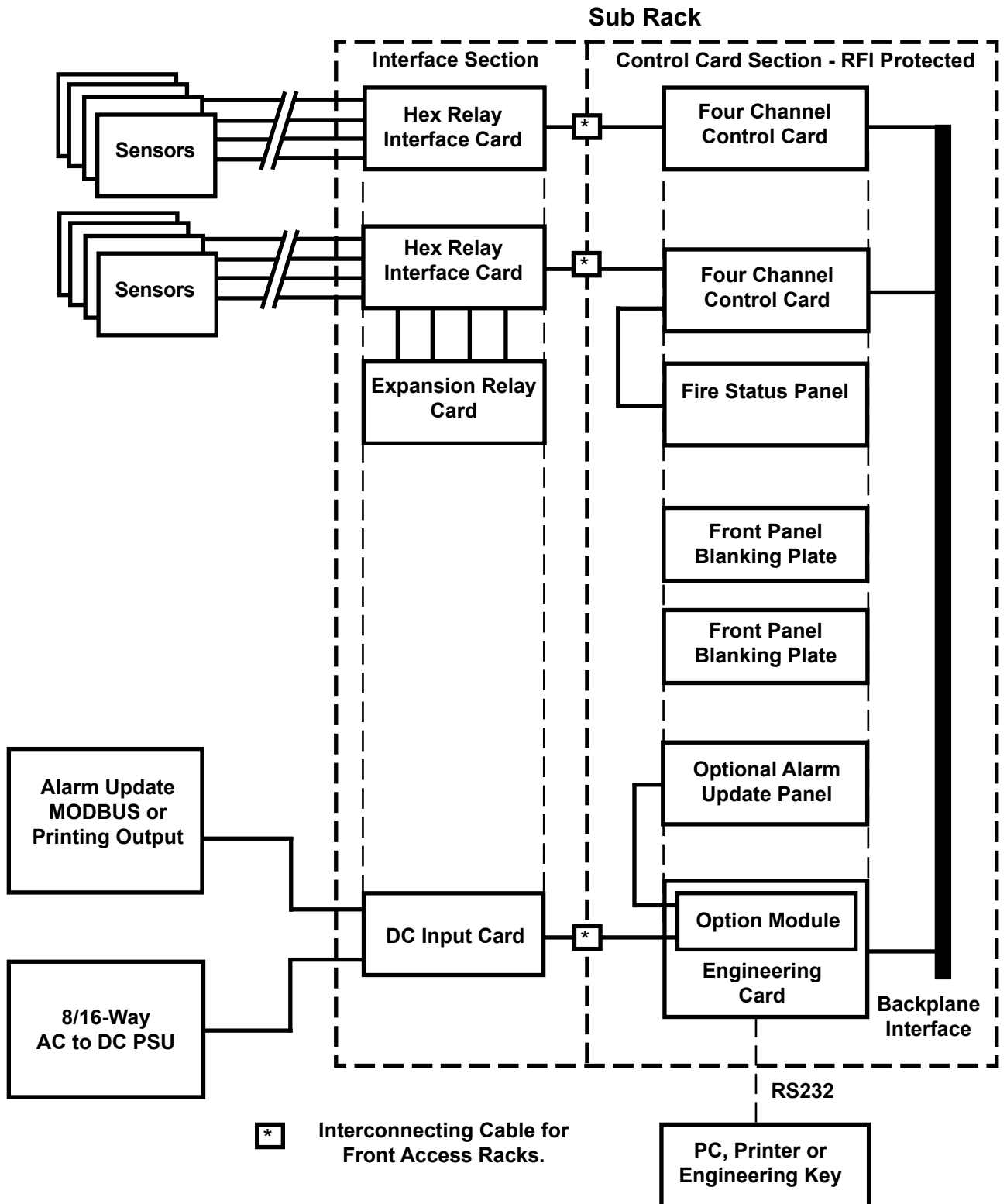

Figure 1 5704F Control System

CHAPTER 1 - SYSTEM CONCEPT

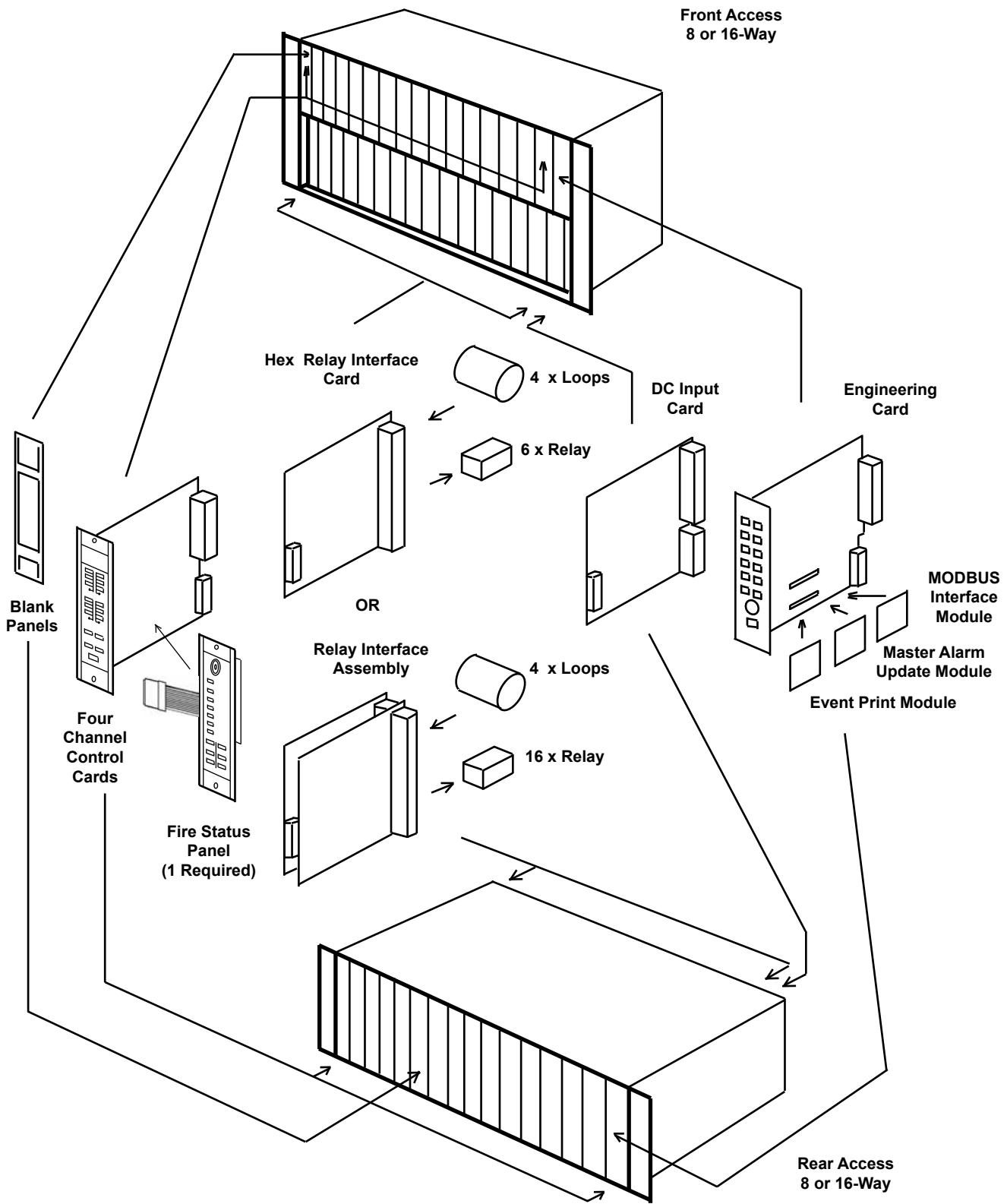

Figure 2 5704 Control System Over View

CHAPTER 2 - SYSTEM DESCRIPTION

5704F SERIES CONTROL SYSTEM CHAPTER 2 SYSTEM DESCRIPTION

CHAPTER 2 - SYSTEM DESCRIPTION

CONTENTS

Section	Page
1. INTRODUCTION	2-3
2. RACKS	2-4
3. CABINETS	2-6
4. FOUR CHANNEL CONTROL CARDS	2-8
4.1 5704F Fire Control Card	2-8
4.2 Control Functions	2-8
4.3 Physical Layout	2-9
5. 5704F FIRE STATUS PANEL	2-11
6. HEX RELAY INTERFACE CARD AND RELAY INTERFACE ASSEMBLY	2-11
6.1 General	2-11
6.2 Hex Relay Interface Card	2-12
6.3 Fire Relay Interface Assembly	2-15
7. ENGINEERING CARD	2-19
8. DC INPUT CARD	2-20
8.1 General	2-20
8.2 DC Input Card Rear Access Connections	2-21
8.3 DC Input Card Front Access Connections	2-22
9. AC TO DC POWER SUPPLY UNITS	2-23
9.1 Types of Power Supply Unit	2-23
9.2 Power Supply Unit Upgrades	2-23
9.3 Power Supply Connections	2-23
9.4 8-Way AC to DC Power Supply Unit Layout	2-24
9.5 16-Way AC to DC Power Supply Unit Layout	2-24
9.6 50W Sub-Unit Layout	2-25
9.7 100W Sub-Unit Layout	2-25
10. FRONT PANEL BLANKING PANEL	2-26

CHAPTER 2 - SYSTEM DESCRIPTION

1. INTRODUCTION

The 5704F Series Control System is a microprocessor based system which controls and displays the status of connected fire detectors. The system provides complex alarm handling facilities with a full maintenance capability.

A rack system is fitted with a number of Four Channel Control Cards each with an associated Hex Relay Interface Card which provides the necessary detector input and optional relay output connections. A Hex Relay Interface Assembly may be used to expand the number of relay outputs available for each of the Four Channel Control Cards. Simple alarm handling and operation is provided by each channel control card.

Complex alarm handling is achieved by communication between a specified number of control cards via the backplane of the rack.

An Engineering Card is fitted to each rack and provides control of the rack backplane communications, control card interrogation and facilitates maintenance.

In small to medium systems power supplies, auxiliary power supplies and battery back up systems can be connected to the rack via a DC Input Card. In heavily populated installations power supplies are connected to each individual Four Channel Control Card via its interface card.

CHAPTER 2 - SYSTEM DESCRIPTION

2. RACKS

Each rack assembly contains a sub-rack, Engineering Card, DC Input Card, key kit and where necessary an interconnecting cable.

Dependent upon configuration, the control system is housed in one of four standard size sub-racks as follows:

- a. Full 19 inch wide by 3U high - Part Number 05701-A-0511, for rear field wiring connections.
- b. Full 19 inch wide by 6U high - Part Number 05701-A-0501, for front field wiring connections.

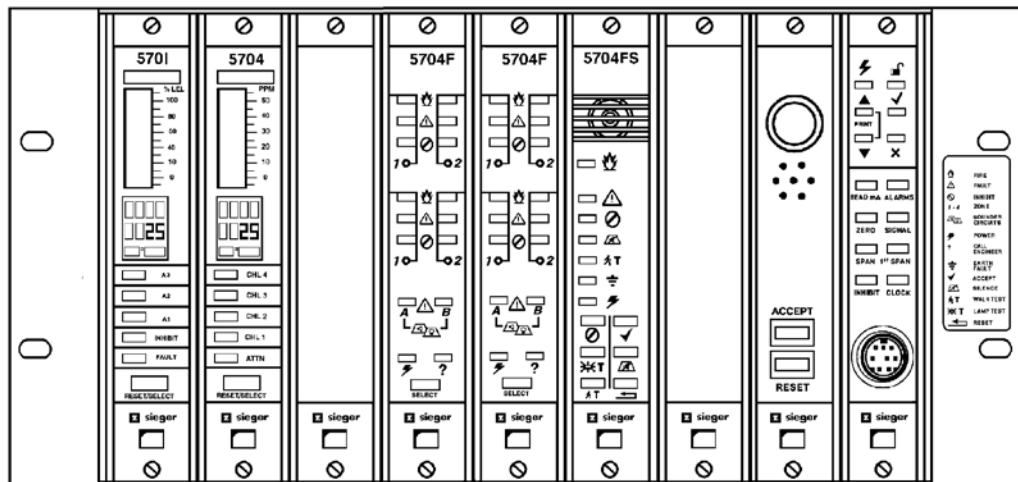

Typical Eight Card Rear Access Rack - Front View

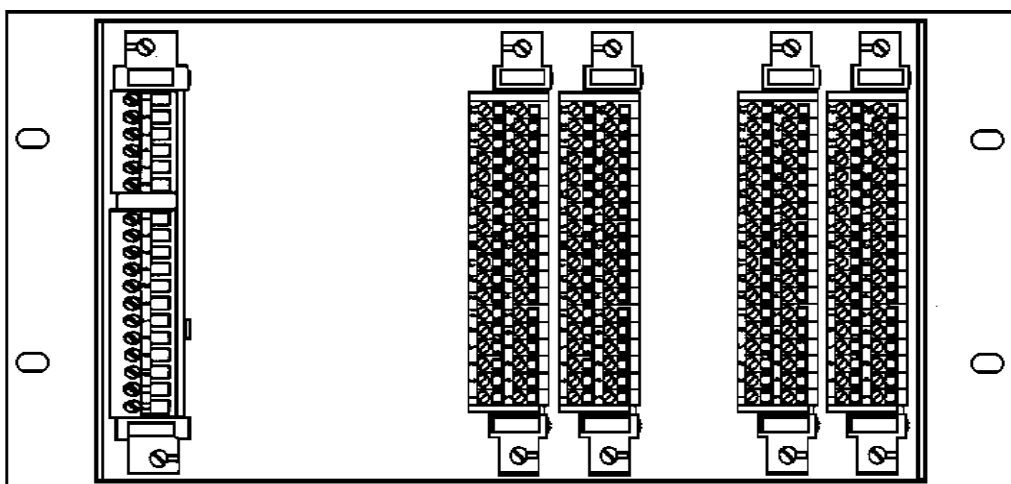

Typical Eight Card Rear Access Rack - Rear View

CHAPTER 2 - SYSTEM DESCRIPTION

- c. Half 19 inch wide by 3U high - Part Number 05701-A-0512,
for rear field wiring connections.
- d. Half 19 inch wide by 6U high - Part Number 05701-A-0502,
for front field wiring connections.

All four versions have two separate chambers. One is sealed against electromagnetic interference and contains the control cards while the other chamber contains the relay interface cards. A backplane between the two chambers provides a path for signal routing between individual control cards and the Engineering Card.

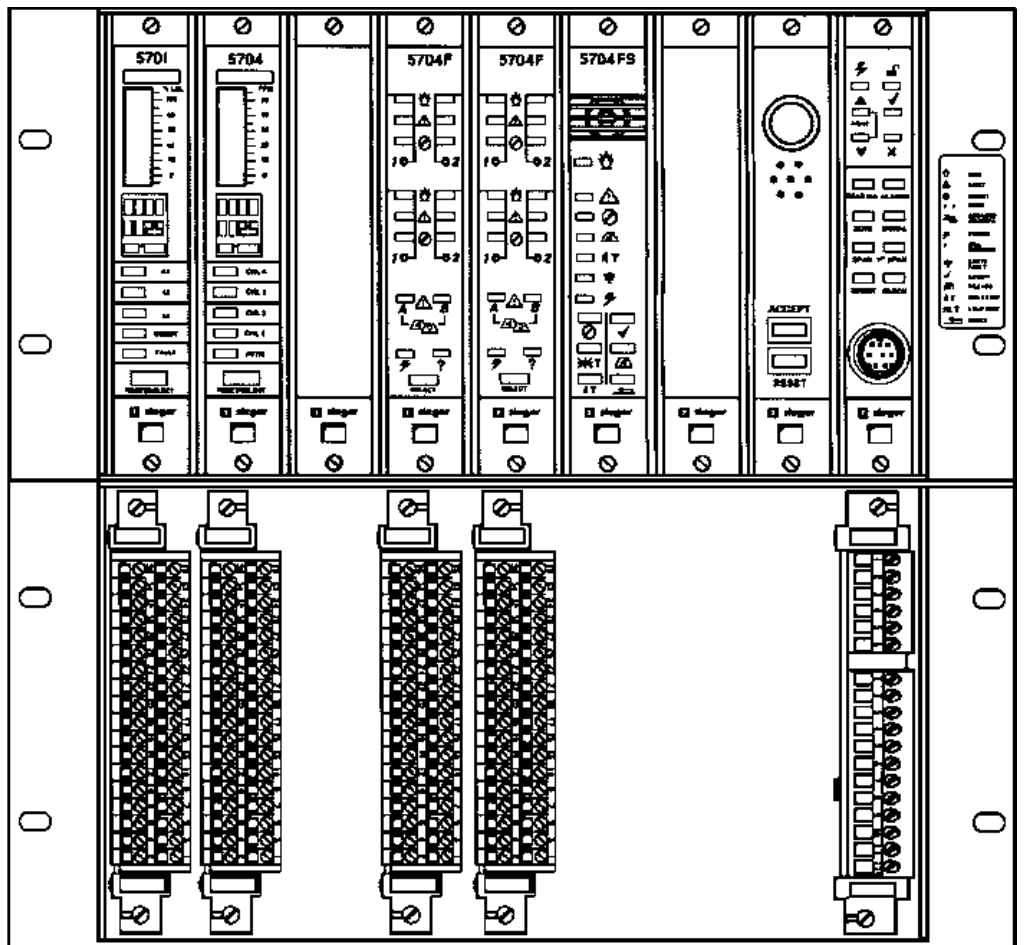

Typical Eight Card Front Access Rack
(Relay/Interface Chamber Front Cover Removed)

CHAPTER 2 - SYSTEM DESCRIPTION

3. CABINETS

Two wall mounted cabinets are used to house:

- a. the full width 16 card front access rack,
(Part Number 05701-A-0451)
- b. or the eight card half width front access rack.
(Part Number 05701-A-0452)

A front door on each cabinet provides security and dust protection, while a clear panel in the door allows the channel card displays to be viewed when the door is closed. The base of each cabinet contains a selection of preformed knockout cable gland entries. A removable plate is fixed to the inside of the cabinet for mounting accessories.

Cabinet

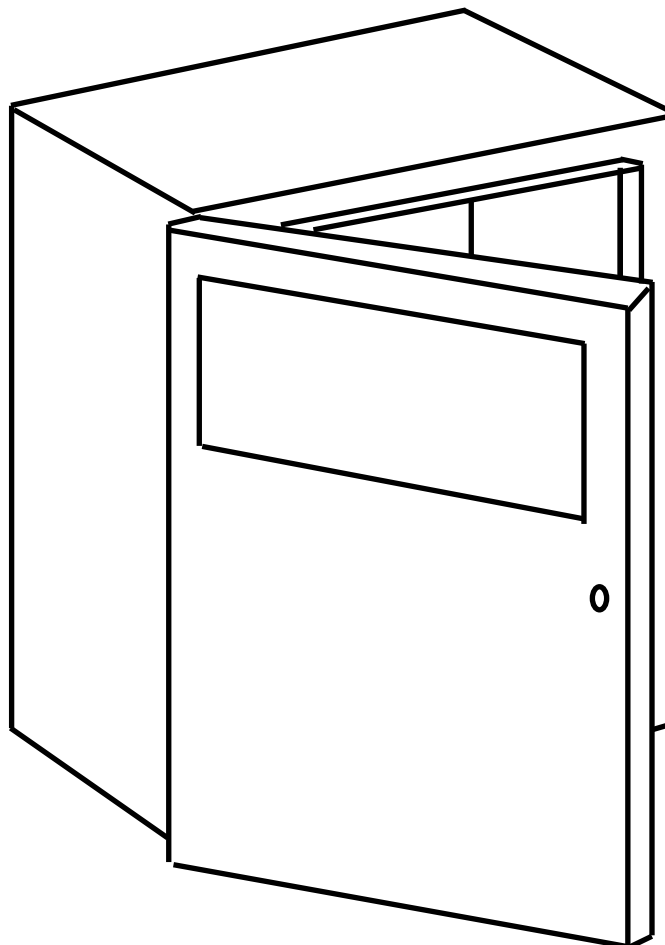

CHAPTER 2 - SYSTEM DESCRIPTION

Eight Card Cabinet Installation

Blanking Panel

8-Way AC to DC Power Supply Unit

Control Cards, Fire Status Panel and Engineering Card

Interface/Relay Cards and DC Input Card

Accessory Plate suitable for mounting DIN rails, circuit breakers, relays, etc.

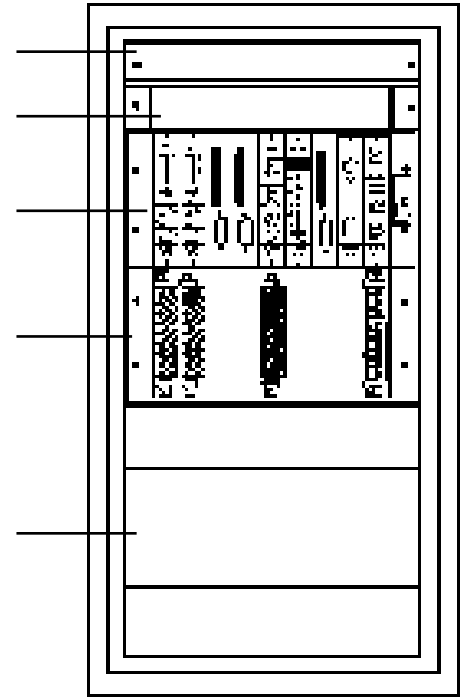

16 Card Cabinet Installation

Blanking Panel

16-Way AC to DC Power Supply Unit

Control Cards, Fire Status Panel and Engineering Card

Interface/Relay Cards and DC input Card

Accessory Plate suitable for mounting DIN rails, circuit breakers, relays, etc.

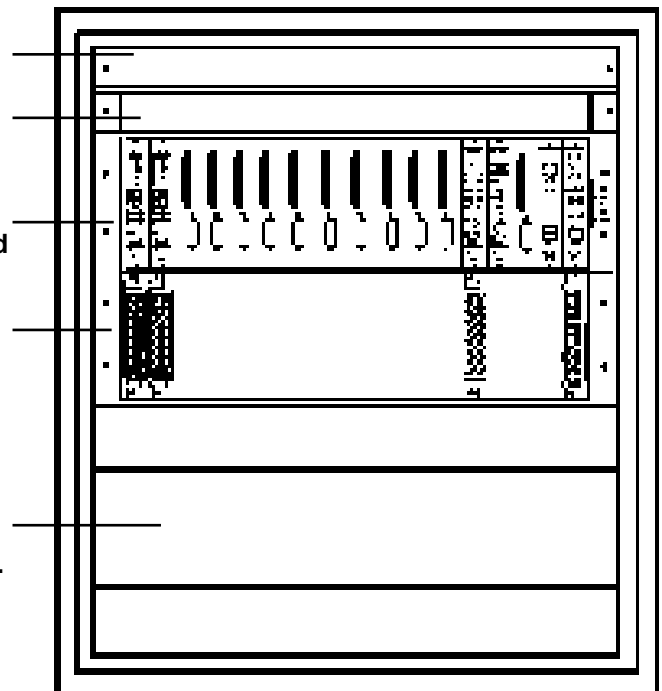

CHAPTER 2 - SYSTEM DESCRIPTION

4. FOUR CHANNEL FIRE CONTROL CARDS

4.1 5704F Fire Control Card (Part Number 05704-A-0146)

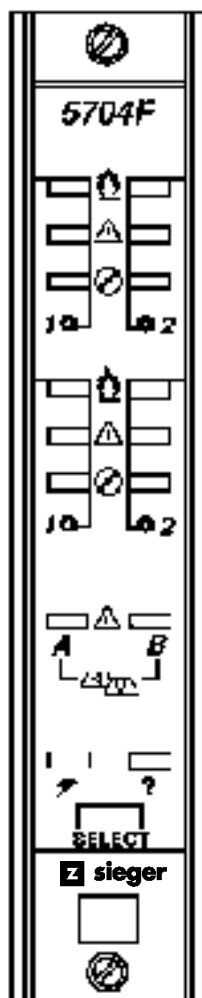

The 5704F Four Channel Fire Control Card provides control, display and alarm facilities for up to four separate loops (or zones) of fire detection. Depending upon the type of detector each loop may have more than one detector. The card also provides two fault monitored switched dc outputs and a minimum of six volt free outputs. The front panel uses clear LED displays to indicate the status of all input and output loops and card status. A push-button is provided for selecting the card for use with the Fire Status Panel and Engineering Card.

The operation of the control card is microprocessor controlled and is fully definable for a wide range of connected fire detectors and application requirements. The setup information is stored in a non-volatile memory on the fire card. A number of user selectable jumper links are also provided for compatibility with some system requirements.

The single fire card covers all common applications, no other plug-in modules are required.

4.2 Control Functions

The 5704F Four Channel Control Card carries out the control functions for up to four loops of fire detection as follows:

- a. Provides the necessary voltages and currents to drive the connected sensors.
- b. Processes the incoming sensor signals.
- c. Compares each loop input signal level with pre-defined fault and alarm limits.
- d. When the pre-defined limits are exceeded, raises the alarm or fault indications by lighting up front panel LEDs and operating the relay and/or switched dc outputs.
- e. Informs other cards of the input status information.
- f. Self validates the operation of its circuit components, software operation and the condition of the loop inputs, remote input and dc switched outputs.

CHAPTER 2 - SYSTEM DESCRIPTION

4.3 Physical Layout

The physical layout of the Four Channel Control Card is shown below:

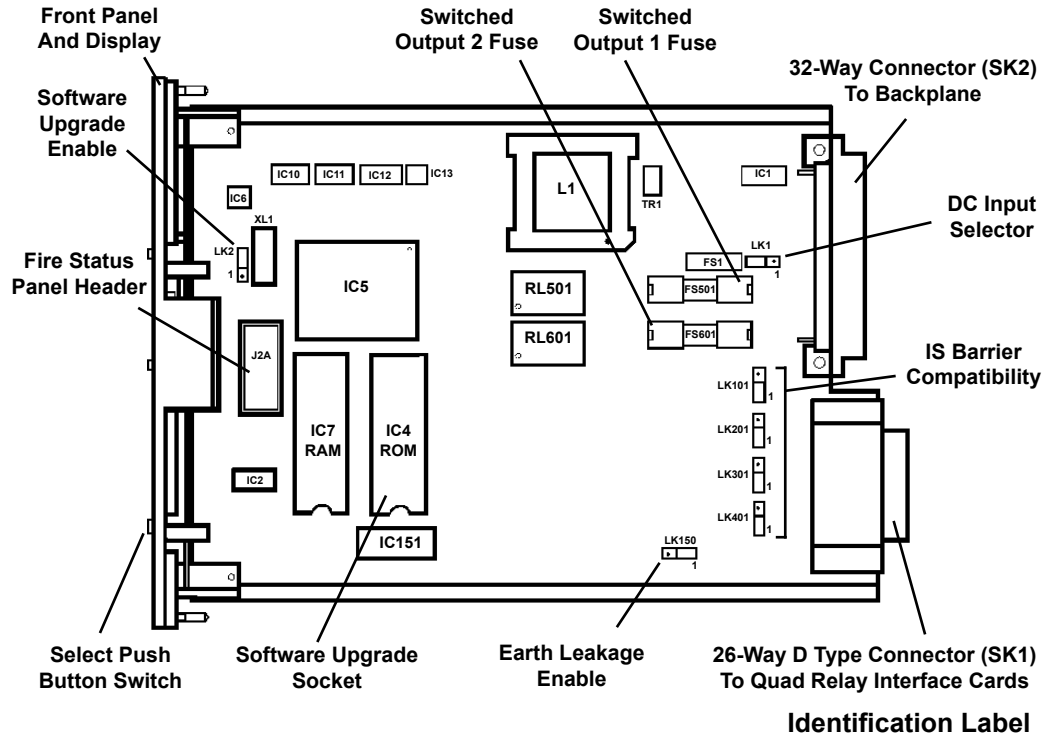

Various user selectable link settings may be required and the link default positions and functions are as follows:

LK1 DC Input Selector

Default position 1 to 2 to power card from backplane.

Link 2 to 3 to isolate the card +24V dc from backplane when the card is individually powered

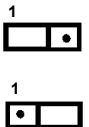

LK2 Software Upgrade Enable

Default position 2 to 3 for internal ROM.

Link 1 to 2 to enable the external ROM operation when fitting an upgrade EPROM into socket IC4.

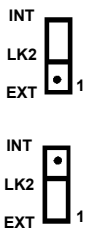

CHAPTER 2 - SYSTEM DESCRIPTION

LK150 Earth Leakage Fault Detection Enable

Default position 1 to 2 to disable detection.

Link 2 to 3 to enable the earth leakage detection circuit.

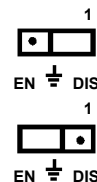

IMPORTANT

This link should be set on one fire card only and usually the card connected to the Fire Status Panel.

LK101, 201, 301, 401 I.S. Input Compatibility.

Individual setting for inputs 1 to 4 respectively.

Default position 1 to 2 for normal operation.

Link 2 to 3 when using an external I.S. barrier.

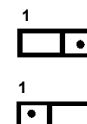

J2A Fire Status Panel Header Socket.

FS501, FS601 DC Output Fuses

Fault monitored switched dc output fuses with individual fuses for output A and B respectively. Replace only with a fuse of similar size and specification.

IC4, IC7 Memory Expansion Socket

For ROM and RAM respectively.

Note: IC5 is factory programmed with software therefore it is quite normal for sockets IC4 and IC7 to be empty.

CHAPTER 2 - SYSTEM DESCRIPTION

5. 5704F Fire Status Panel (Part Number 05704-A-0148)

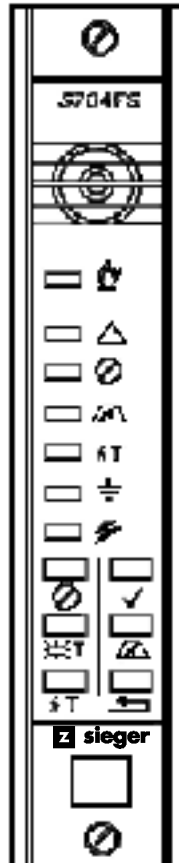

The 5704FS Fire Status Panel is a 1" wide 3U high panel with a flying lead that matches a header on the fire card. The panel uses clear LED displays and an audible alert sounder to provide a common indication of the status of the fire detection system. Six push-buttons are provided for user operation and maintenance of the fire system.

The Fire Status Panel must be fitted immediately to the right of one of the Fire Control Cards to which it is connected via a short flying lead. Only one status panel

is required per rack. The fire status panel is used in conjunction with the Engineering Card to provide the following additional facilities:

- Common indicator lamps for Fire, Fault, Inhibit, Silence, Walk Test and Earth Leakage Fault.
- An audible alert for Fire, Fault, Accepted Fire and Accepted Fault.
- Common user controls for Accept, Silence, Reset and Lamp Test
- Channel functions for Walk Test and Inhibit.

6. HEX RELAY INTERFACE CARD AND RELAY INTERFACE ASSEMBLY

6.1 General

The Hex Relay Interface Card provides the interface between a Four Channel Control Card and the field wiring.

An Expansion Relay Card can also be factory fitted to the Hex Relay Interface Card and the resultant assembly is then known as the 5704F Fire Relay Interface Assembly. This assembly is used to expand the standard six relays available for alarms on the Hex Relay Interface to 16 relays.

CHAPTER 2 - SYSTEM DESCRIPTION

6.2 Hex Relay Interface Card (Part Number 05704-A-0131)

6.2.1 General

Provides connections between the four detector loops and the control card. In addition, six single pole relays provide voltage free contact outputs that can be configured for the fire, fault or inhibit conditions and as individual alarms or master alarms. Connections for power and remote inputs are also provided.

The front and rear access connections are shown in Sections 6.2.2 and 6.2.3 respectively while the physical layout is shown below:

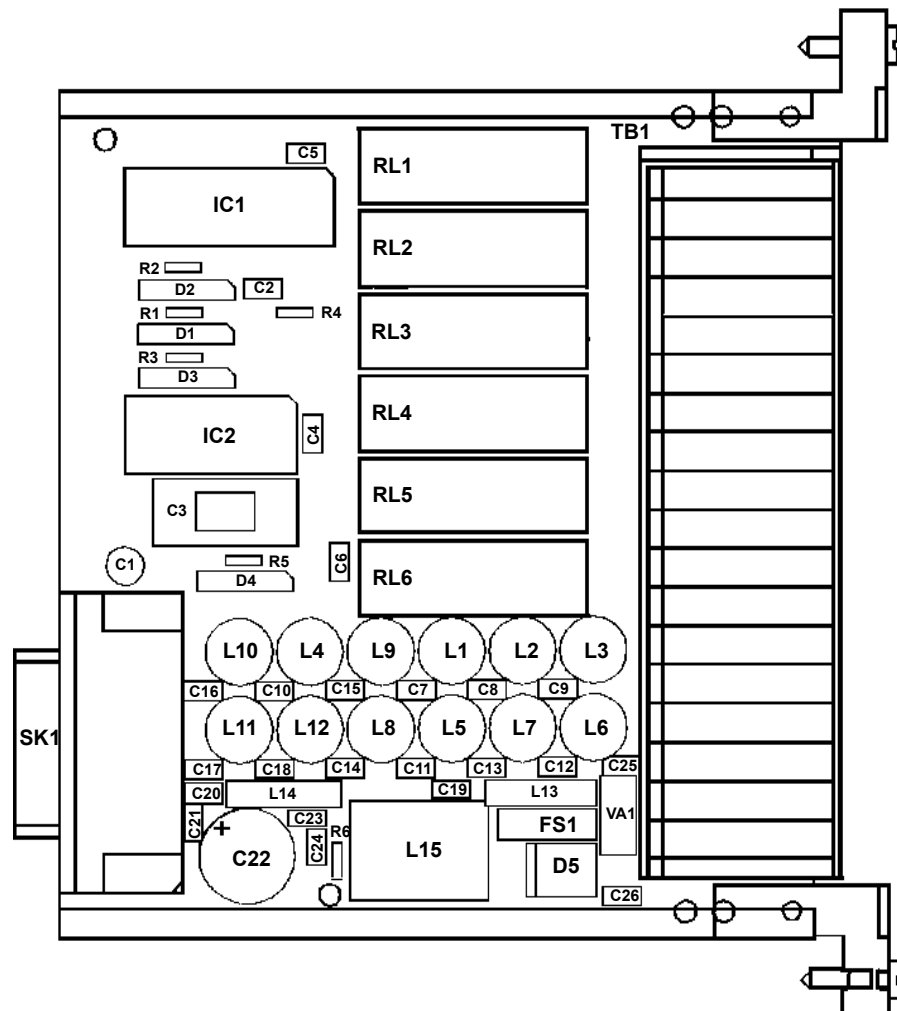

CHAPTER 2 - SYSTEM DESCRIPTION

6.2.2 Hex Relay Card Rear Access Connections

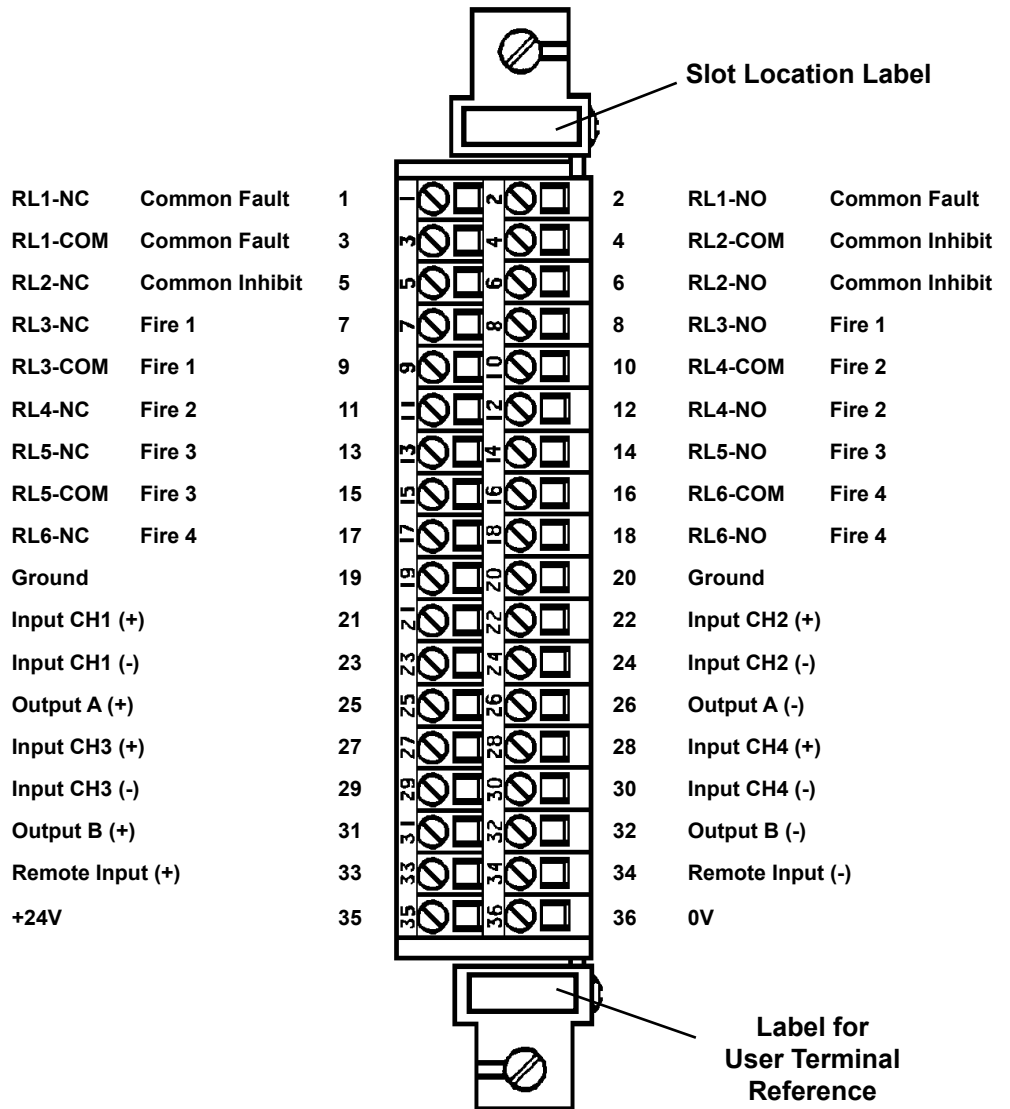

1. NC = Normally Closed. NO = Normally Open. COM = Common.
2. Relay contact conditions refer to the no power state of the relay.
3. The functions shown for terminals 1 to 18 are the default functions for relays RL1 to RL6 only. For other configurations - refer to the configuration printout.

CHAPTER 2 - SYSTEM DESCRIPTION

6.2.3 Hex Relay Card Front Access Connections

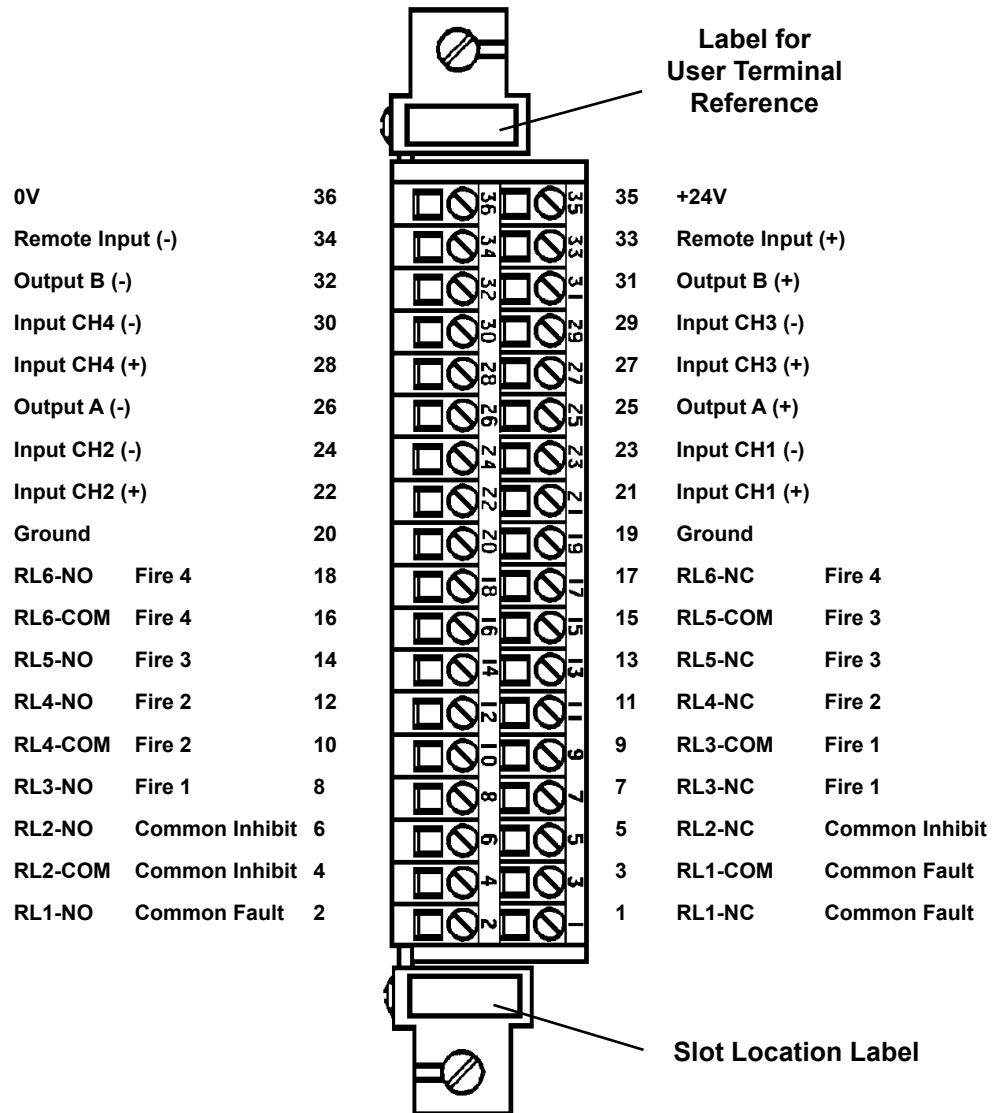

1. NC = Normally Closed. NO = Normally Open. COM = Common.
2. Relay contact conditions refer to the no power state of the relay.
3. The functions shown for terminals 1 to 18 are the default functions for relays RL1 to RL6 only. For other configurations - refer to the configuration printout.

CHAPTER 2 - SYSTEM DESCRIPTION

6.3 Fire Relay Interface Assembly (05704-A-0123)

6.3.1 General

The Expansion Relay Card provides relay expansion for a Four Channel Control Card and the Hex Relay Interface Card. The Expansion Relay Card is connected to the Hex Relay Interface Card and provides 12 additional relays, eight of which are single pole change-over and four are single pole single throw. The relays can be configured for fire, fault or inhibit alarms and as individual or master outputs.

When the Expansion Relay Card is connected to the Hex Relay Interface Card, the pair of cards take up two slots of the rack. For this reason a blank panel (or Fire Status Panel) has to be fitted to the rack front panel adjacent to the associated Four Channel Control Card.

The front and rear access connections are shown in Sections 6.3.3 and 6.3.4 respectively while the physical layout is shown below:

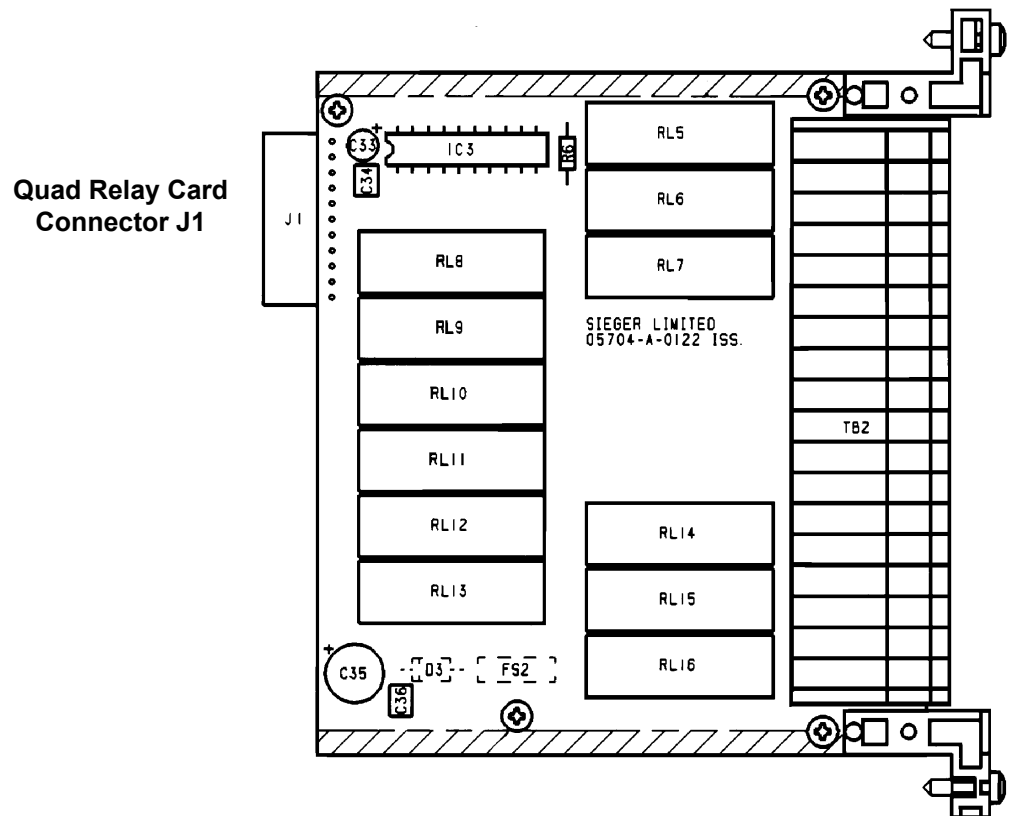

CHAPTER 2 - SYSTEM DESCRIPTION

6.3 2 Fire Relay Interface Assembly Layout

The following diagrams show the Expansion Relay Card fitted to the Hex Interface Relay Card to form a 5704F Fire Relay Interface Assembly:

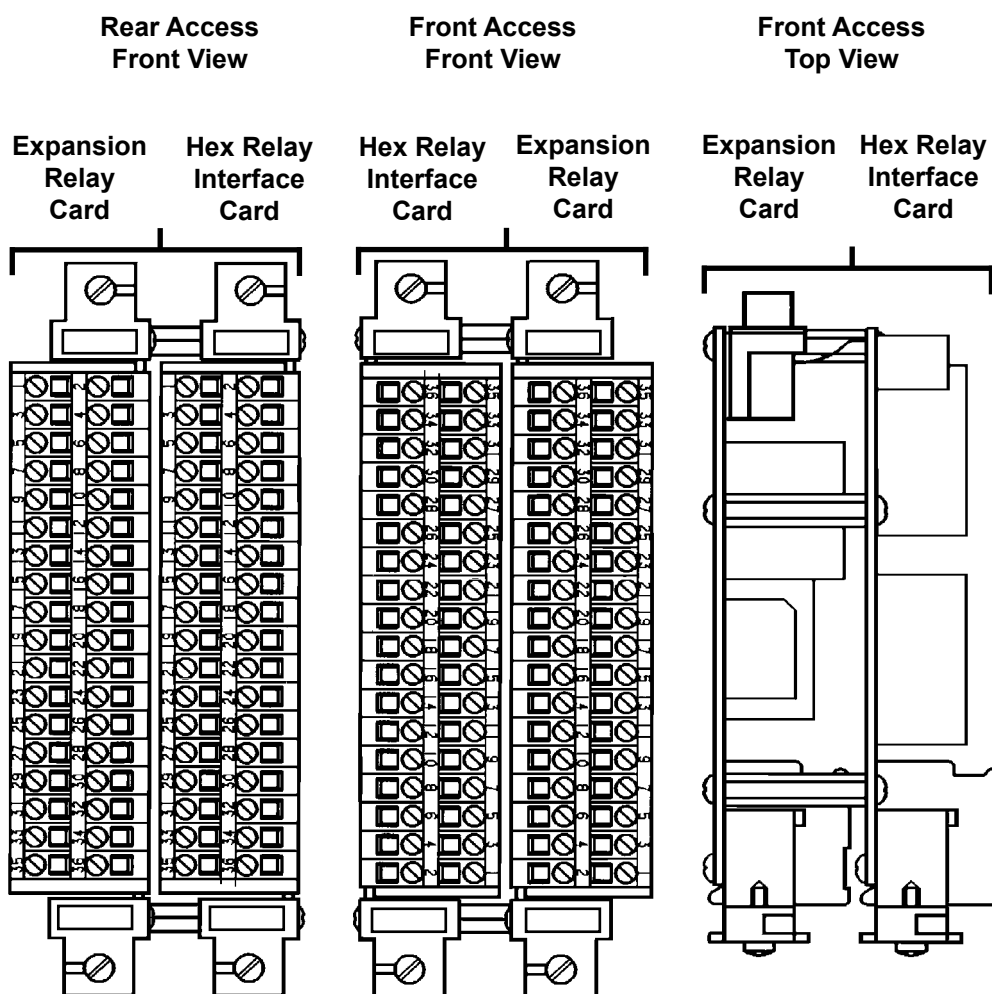

1. For details of the Hex Interface Card, see Section 6.2.
2. For details of the Expansion Relay Card, see Sections 6.4.

CHAPTER 2 - SYSTEM DESCRIPTION

6.3.3 Fire Relay Interface Assembly Rear Access Connections

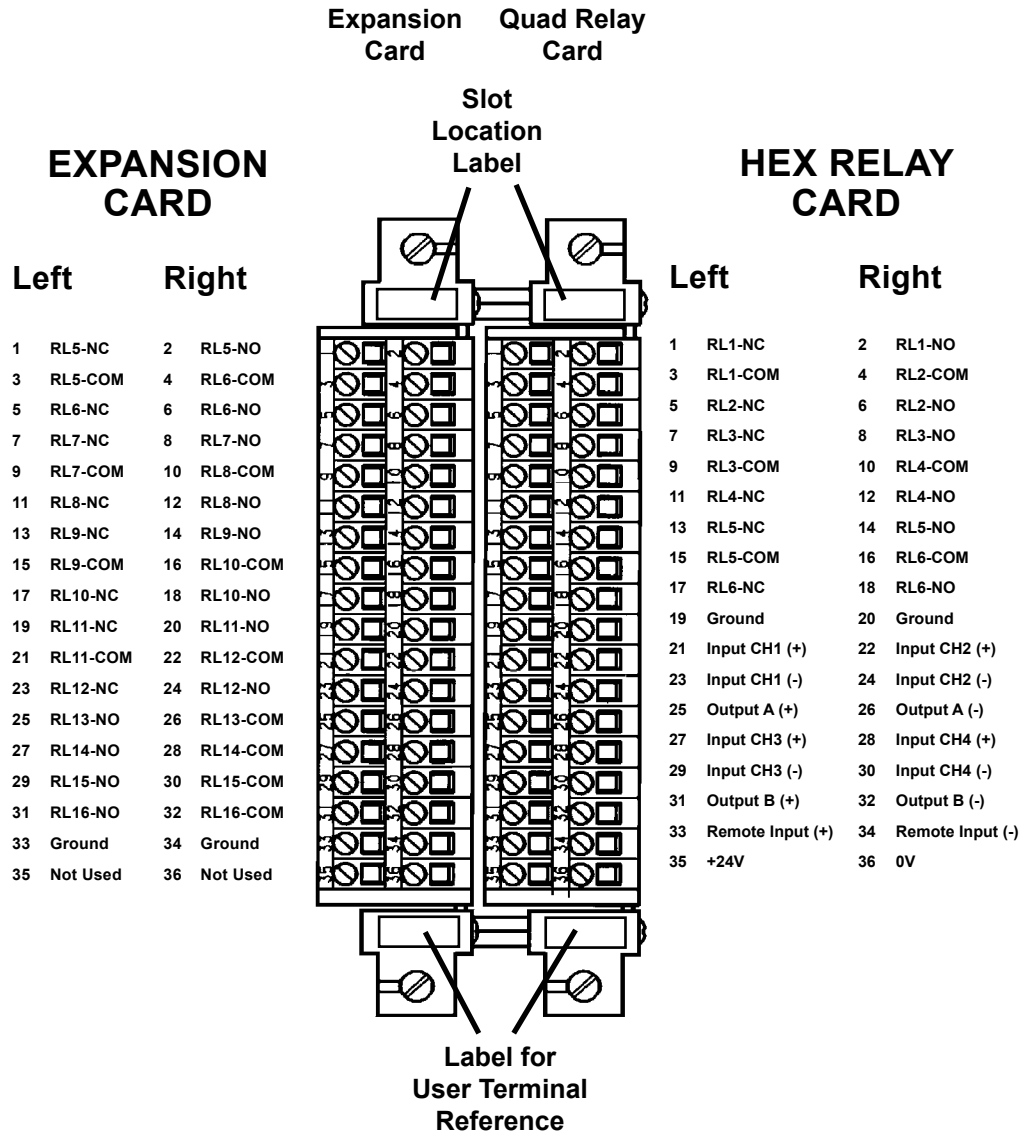

1. NC = Normally Closed. NO = Normally Open. COM = Common.
2. Relay contact conditions refer to the no power state of the relay.
3. For relay functions, refer to the configuration printout supplied with the system.

CHAPTER 2 - SYSTEM DESCRIPTION

6.3.4 Fire Relay Interface Assembly Front Access Connections

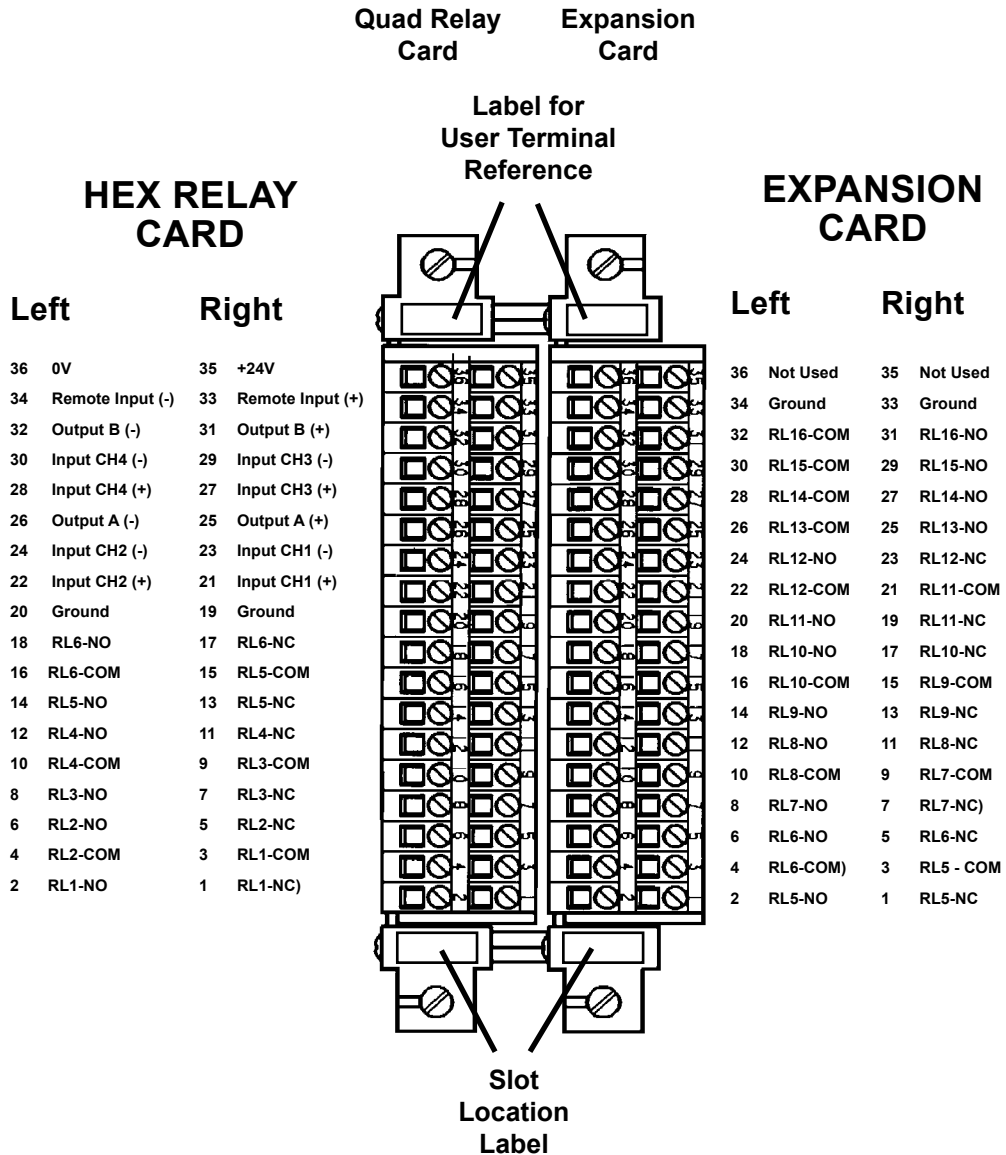

1. NC = Normally Closed. NO = Normally Open. COM = Common.
2. Relay contact conditions refer to the no power state of the relay.
3. For relay functions, refer to the configuration printout supplied with the system.

CHAPTER 2 - SYSTEM DESCRIPTION

7. ENGINEERING CARD (PART NUMBER 05701-A-0361)

The Engineering Card is used in conjunction with the Fire Status Panel on a System 57 rack to provide a common interface that enables the user to perform all the required functions to commission and operate each fitted control card.

The front panel is fitted with a series of tactile push-buttons for the operation of various functions, LEDs to provide rack power and communications status and a mini DIN socket for the connection of a serial printer, computer or an engineering key. The Engineering Key is used to unlock functions that can alter the operation of a control card.

The Engineering Card is always fitted into the right-hand slot of the rack and provides:

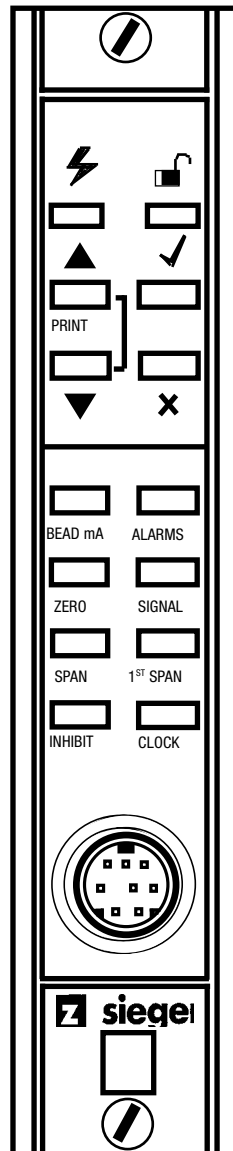

- a. Routing of the 24V dc input from the DC Input Card to the backplane of the rack.
- b. A backplane serial communications controller and monitor.
- c. A time and date reference.
- d. An RS232 external engineering interface.
- e. Depending upon the security level, the operation of the following rack facilities:
 - Catalytic sensor head current monitoring and adjustment.
 - Alarm set point checking, adjustment and testing.
 - Sensor signal zero adjustment.
 - Sensor signal span adjustment and setting of sensor life monitoring values.
 - Sensor line monitoring.
 - Enabling of control card alarm inhibit.
 - Checking and adjustment of the system clock.
- f. Self validation of the operation of its circuit components, software operation and the backplane communications.
- g. A socket for the addition of special modules that expand the System 57 capabilities.

CHAPTER 2 - SYSTEM DESCRIPTION

8. DC INPUT CARD (PART NUMBER 05701-A-0325)

8.1 General

The dc power to the rack can enter the sub-rack via the DC Input Card. This power may be supplied by the user from an external nominal 24V dc supply. The dc supply is routed through the Engineering Card and sub-rack back plane to all cards in the rack and is protected by a fuse on the DC Input Card. There is a two part terminal block, TB1, to aid removal of the card without disconnecting each of the connected wires.

It is necessary to limit the current flow along the rack backplane to 8A. In installations where large number of cards are used or high power sensors are supplied from the rack, it is recommended that the Control Cards are powered via their associated Relay Interface Cards and the DC Input Card is used to power the Engineering Card only.

If required, a stand-by backup battery supply may also be connected to the auxiliary dc input connections.

The PSU and AUX connections are isolated from each other by diodes.

The DC Input Card also provides RFI filtering and reverse polarity protection.

In addition, the DC Input Card provides an interface to the Engineering Card plug-in modules via TB2. The functions of the six terminals will vary dependent upon the module fitted. For full details refer to:

- a. 05701-M-5006 System 57 Control System
Modbus Interface Option RS485/422
- b. 05701-M-5007 System 57 Control System
Event Printing Option RS232
- c. 05701-M-5009 System 57 Control System
Alarm Update Option

CHAPTER 2 - SYSTEM DESCRIPTION

8.2 DC Input Card Rear Access Connections

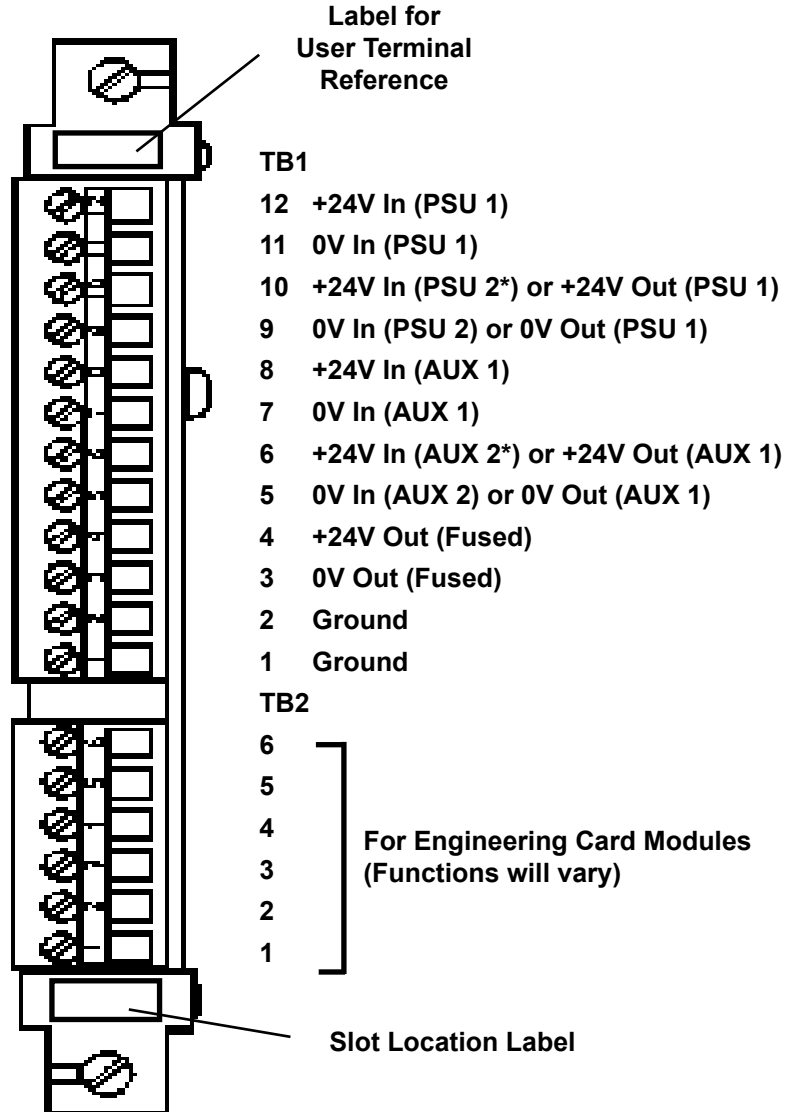

* PSU 1 and PSU 2 (and AUX 1 and AUX 2) must be compatible with parallel connection.

Note: For systems with high power loading, it is recommended that the dc power is connected direct to each channels' Relay Interface Card.

CHAPTER 2 - SYSTEM DESCRIPTION

8.3 DC Input Card Front Access Connections

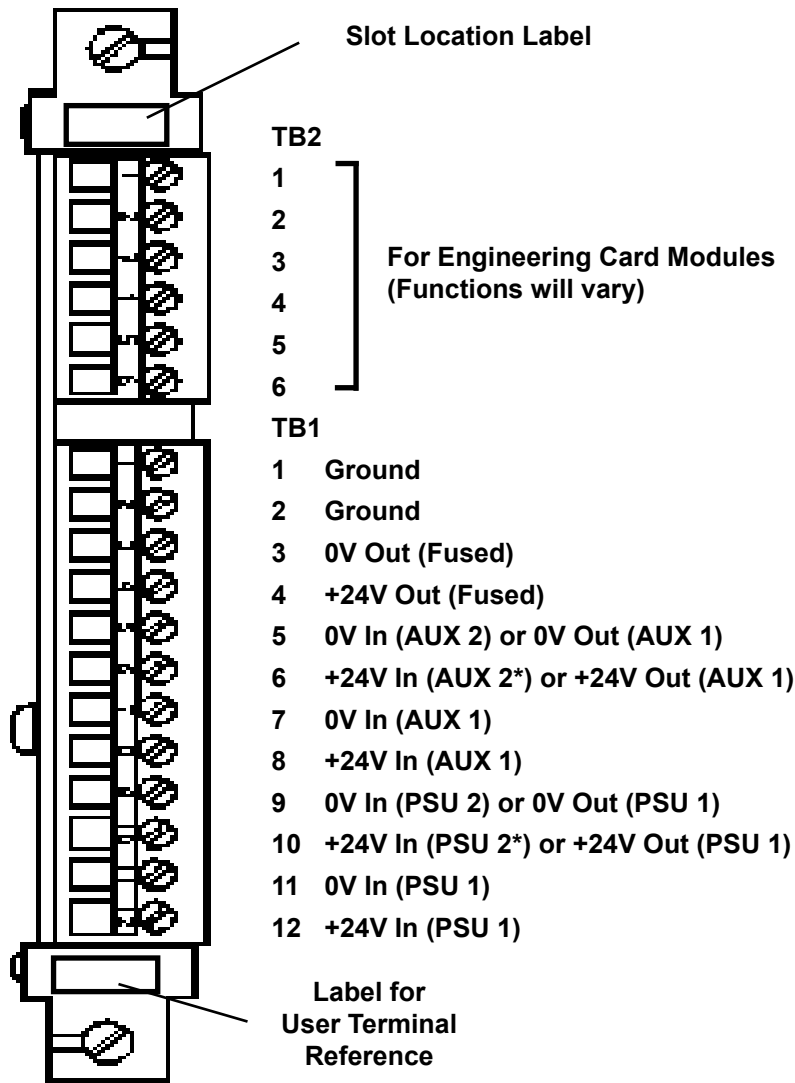

* PSU 1 and PSU 2 (and AUX 1 and AUX 2) must be compatible with parallel connection.

Note: For systems with high power loading, it is recommended that the dc power is connected direct to each channels' Relay Interface Card.

CHAPTER 2 - SYSTEM DESCRIPTION

9. AC TO DC POWER SUPPLY UNITS

9.1 Types of Power Supply Unit

There are two types of AC to DC power supply units:

a. 8-Way AC to DC Power Supply Unit (Part Number 05701-A-0406)

A 1U high half width 19 inch rack mounted unit that contains a single 50W Switched Mode AC to DC Power Supply Module.

b. 16-Way AC to DC Power Supply Unit (Part Number 05701-A-0405)

A 1U high 19 inch rack mounted unit that contains a single 50W Switched Mode AC to DC Power Supply Module.

Both power supply units will operate from an 85V to 264V, 47Hz to 440Hz ac supply, or a 110V to 340V dc supply (Refer to Zellweger Analytics for information on dc supplies).

9.2 Power Supply Unit Upgrades

Both power supply units are provided with internal connections to enable a power upgrade to 100W by the addition of a second 50W Switched Mode AC to DC Power Supply Module (Part Number 05701-A-0440).

A second sub-unit (Part Number 05701-A-0441) can be fitted to the basic 16-way power supply unit if more than 100W is required to operate the system. The additional sub-unit will contain a 50W Switched Mode AC to DC Power Supply Module as standard and will therefore give an additional 50W of available power. If required a further 50W Switched Mode AC to DC Power Supply Module (Part Number 05701-A-0440) can be added to this second sub-unit to bring the power availability up to 200W.

The switched mode power supply modules used are fully overload protected and are designed to be connected together.

9.3 Power Supply Connections

The input ac power supply is connected via a three core cable at the rear of each unit.

The nominal 24V dc output supply is connected via a twin core cable at the rear of each unit.

CHAPTER 2 - SYSTEM DESCRIPTION

9.4 8-Way AC to DC Power Supply Unit Layout

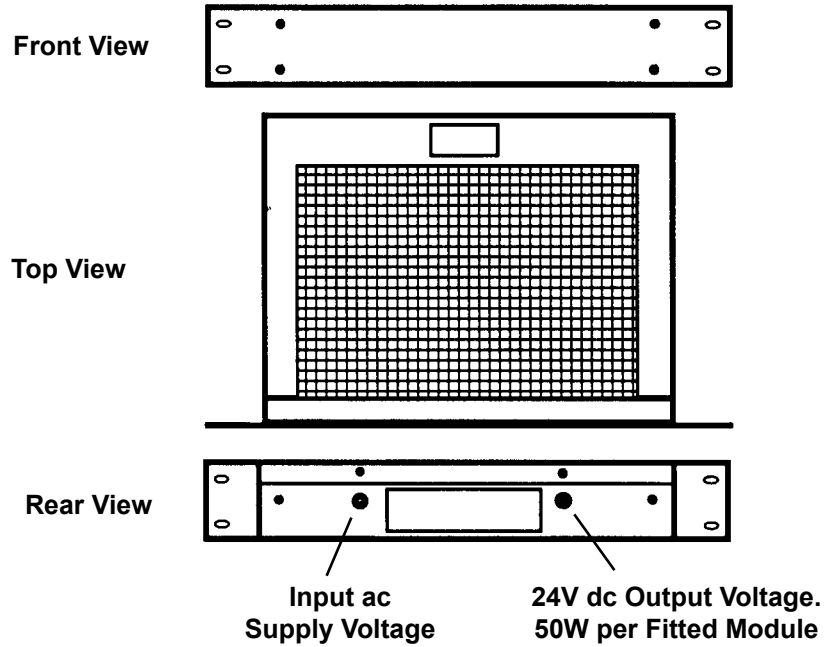

9.5 16-Way AC to DC Power Supply Unit Layout

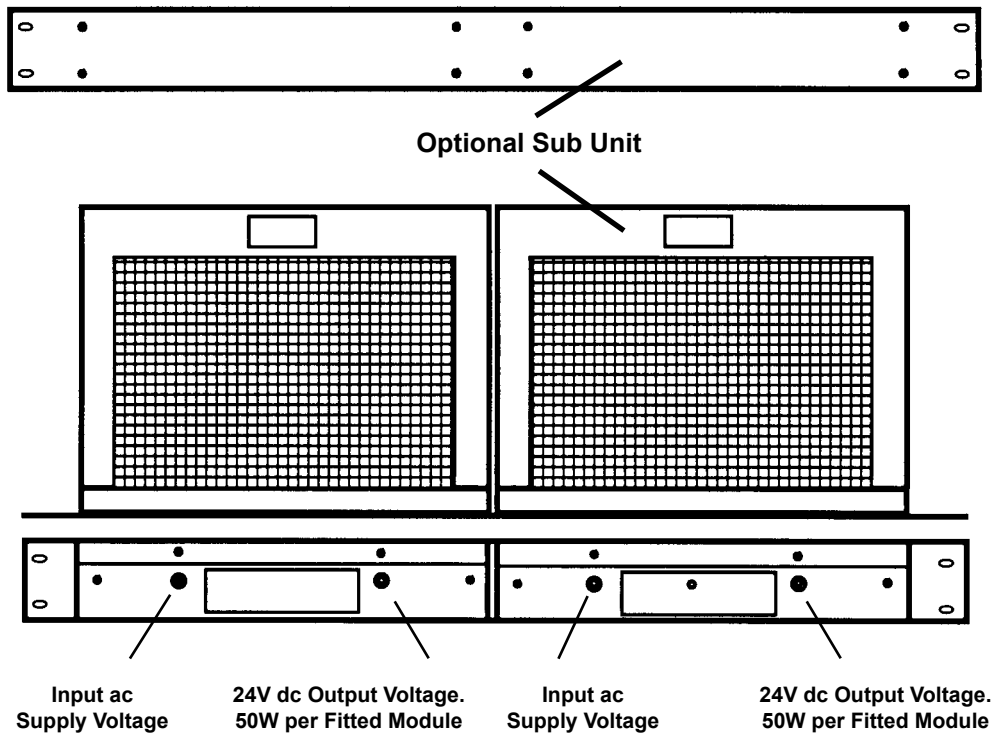

CHAPTER 2 - SYSTEM DESCRIPTION

9.6 50W Sub-Unit Layout

The 50W Sub-unit is fitted with a single 50W Switched Mode AC to DC Power Supply Module as shown below:

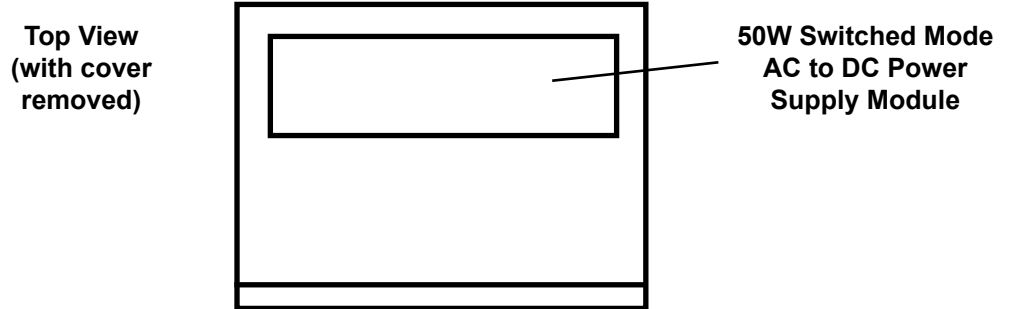

This type of unit is identified on the identification label as follows:

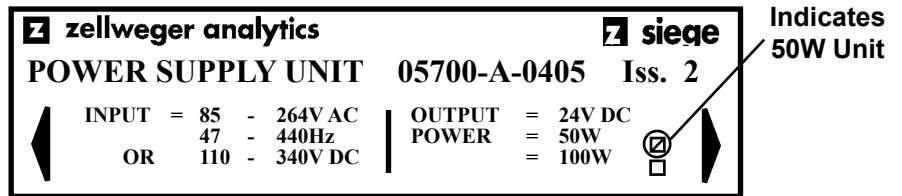

9.7 100W Sub-Unit Layout

The 100W Sub-unit is a 50W Sub-unit with an additional 50W Switched Mode AC to DC Power Supply Module fitted as shown below:

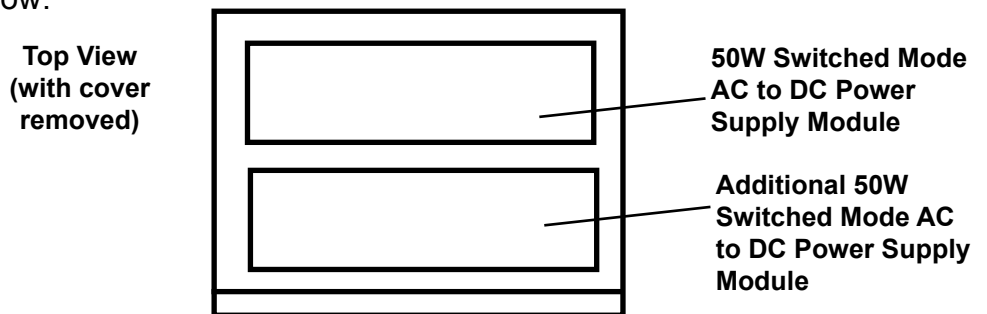

This type of unit is identified on the identification label as follows:

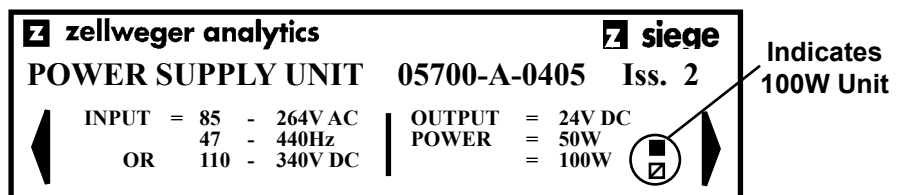

CHAPTER 2 - SYSTEM DESCRIPTION

10. FRONT PANEL BLANKING PANEL

Matching blank front panels are available for fitting to the rack in all unused control card spaces.

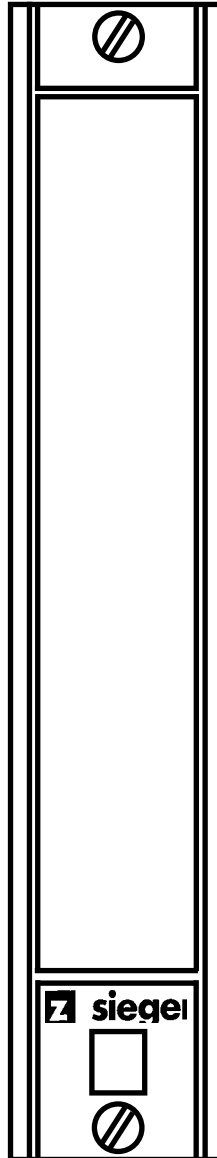

CHAPTER 3 CONTROLS AND FACILITIES

5704F SERIES CONTROL SYSTEM CHAPTER 3 CONTROLS AND FACILITIES

CHAPTER 3 CONTROLS AND FACILITIES

CONTENTS

Section	Page
1. INTRODUCTION	3-5
2. GRAPHICAL SYMBOLS	3-5
3. FACILITY SUMMARIES	3-5
3.1 General	3-5
3.2 Zone Fault Alarm	3-5
3.3 Card Fault Alarm	3-6
3.4 Inhibit Alarm	3-6
3.5 Fire Alarm	3-6
3.6 A1, A2 and A3 Level Alarms	3-6
3.7 Output Fault Alarm	3-6
3.8 Output Silenced Indication	3-7
3.9 Earth Leakage Fault Alarm	3-7
3.10 Remote Input Fault Alarm	3-7
3.11 Power Supply Indicator	3-7
3.12 Walk Test Indicator	3-7
3.13 Individual Alarm	3-8
3.14 Grouped (or Zoned) Alarm	3-8
3.15 Master Alarm	3-8
3.16 Voted Alarm	3-8
3.17 Latched Alarm	3-9
3.18 Non-Latched Alarm	3-9
3.19 Normally Energised	3-9
3.20 Normally De-energised	3-9
4. FOUR CHANNEL FIRE CONTROL CARD	3-9
4.1 General	3-9
4.2 Front Panel Display	3-10
4.3 Front Panel Controls	3-12
4.4 Extraction Slot	3-13
4.5 Fire Card Facilities	3-13
5. FIRE STATUS PANEL	3.19
5.1 General	3.19
5.2 Front Panel Displays	3.20
5.3 Front Panel Audible Alert	3-21
5.4 Front Panel Controls	3-22
5.5 Extraction Slot	3-24

CHAPTER 3 CONTROLS AND FACILITIES

6.	ENGINEERING CARD	3-28
6.1	General	3-28
6.2	LED Indicators	3-28
6.3	Engineering Push-buttons	3-29
6.4	Engineering Serial Port	3-31

TABLES

Table

1.	Summary of Fire Control Card Visual indicator Functionality	3-25
2.	Summary of Fire Status Panel Visual Indicator Functionality	3.26
3.	Summary of Fire Status Panel Audible Indicator Functionality	3.26
4.	Summary of User Control, Maintenance Functions and Remote Inputs	3-27

CHAPTER 3 CONTROLS AND FACILITIES

CHAPTER 3 CONTROLS AND FACILITIES

1. INTRODUCTION

The 5704F Series Control System is equipped to provide the operational and engineering facilities necessary to fully maintain a system of fire detection equipment.











Each 5704F control card within the rack system monitors up to four separate fire loop inputs (or zones), displaying the zone status condition. It is capable of driving two fault monitored switched dc outputs and up to sixteen voltage free contacts. The card also provides for a multi-function remote input and earth leakage fault detection.

Multi-card multi-channel alarm modes are possible via a sophisticated rack wide communication system. The fire control system may be combined with other System 57 gas control cards within a single rack to provide truly integrated fire and gas detection system.

Further information can be gathered and, depending upon the security status, certain settings can be adjusted by means of a common Fire Status Panel and Engineering Card fitted to the rack.

2. GRAPHICAL SYMBOLS

The various controls and indicators of the Fire Card and Fire Status Panel are identified using graphical symbols. A quick reference symbol key is provided by a label, as illustrated, attached to the mounting flange of the rack.

	FIRE
	FAULT
	INHIBIT
1 - 4	ZONE
	SOUNDER CIRCUITS
	POWER
?	CALL ENGINEER
	EARTH FAULT
	ACCEPT
	SILENCE
	WALK TEST
	LAMP TEST
	RESET

3. FACILITY SUMMARIES

3.1 General

The outputs of the system can be configured to provide a range of alarm and status functions which are explained in the following paragraphs. It is important to refer to the configuration printout supplied with all new systems to identify any changes from the default settings.

3.2 Zone Fault Alarm ()

There are four zone fault alarms, one per loop. The alarms activate when a fault is detected in the zone loop signal. This may be caused by faulty wiring or a faulty detector. Each zone fault alarm has a separate front panel indicator lamp and there is a common indicator lamp on the Fire Status Panel. By default all zone fault alarms are associated with the same relay to provide a general card fault output.

CHAPTER 3 CONTROLS AND FACILITIES

3.3 Card Fault Alarm (?)

There is a single card fault alarm. The alarm activates if a serious error is detected in the operation of the control card. The alarm is indicated by continuous illumination of the call engineer lamp on the front panel. By default the card fault alarm is also associated with the same relay as the zone faults to provide a general card fault output.

3.4 Inhibited Alarm (⊘)

There are four inhibit alarms, one per zone. The alarm activates when the respective zone is inhibited from causing an alarm or fault condition. Each zone inhibit alarm has a separate front panel indicator lamp and there is a common indicator lamp on the Fire Status Panel. By default all zone inhibited alarms are associated with the same relay to provide a common card inhibit output.

3.5 Fire Alarm (🔥)

There are four fire alarms, one per loop input (or zone). The fire alarms activate when the respective zone signal indicates a detector in alarm. Each zone fire alarm has a separate front panel indicator lamp and there is a common indicator lamp on the Fire Status Panel. By default a single relay is associated individually to each fire zone and both fault monitored switched outputs are associated with all four fire zones.

3.6 A1, A2 and A3 Level Alarms

Although the A1, A2 and A3 level alarms are only generated by 5701/5704 Gas Control Cards. The fire card can receive this status information and make use of it in the generation of multi-card alarms (eg. master and grouped alarms). There are no visual indicators for the multi-card alarms it is therefore important to ensure correct configuration and proper operation during commissioning.

3.7 Output Fault Alarm (⚠)

There are two output fault alarms, one per fault monitored switched output. The output fault alarm activates when the fault monitoring of the respective output indicates a problem that might prevent correct operation. This may be caused by short circuit or open circuit wiring. Each output fault alarm has a separate front panel indicator lamp and there is a common indicator lamp on the Fire Status Panel. By default all output fault alarms are associated with the same relay as the zone faults to provide a general card fault output.

CHAPTER 3 CONTROLS AND FACILITIES

3.8 Output Silenced Indication ()

The switched and voltage free outputs can be configured to respond to a silence command that can be initiated via the remote input or Fire Status Panel. The silence condition suppresses outputs that have activated due to the occurrence of a fire or fault condition allowing the causal action to be investigated. The silence condition is automatically cancelled if a new fire condition occurs on any zone in the system. There is a single common silenced condition indicator lamp on the Fire Status Panel. The silence indicator activates whenever the silence condition is active. The silence condition itself can not be associated with any relay output.

3.9 Earth Leakage Fault Alarm ()

Although each card is equipped with the earth leakage detection circuit it is important that the enabling link is set on one card only. The earth leakage fault alarm activates when the fault monitoring system detects an electrical connection between the system dc supply and earth. There is a common earth leakage indicator lamp on the Fire Status Panel which operates in conjunction with a slow flash of the call engineer lamp on the front panel of the fire card detecting the problem. By default the earth leakage fault alarm is associated with the same relay as the zone faults to provide a general card fault output.

3.10 Remote Input Fault Alarm ()

There is a single remote input fault alarm. The alarm activates when the fault monitoring of the remote input indicates a problem that might prevent correct operation. This may be caused by short circuit or open circuit wiring. The alarm is indicated by slow flashing illumination of the call engineer lamp on the front panel. By default the remote input fault alarm is associated with the same relay as the zone faults to provide a general card fault output.

3.11 Power Supply Indicator ()

The fire card continuously monitors the dc input and in the event of insufficient voltage an indication is given by flashing the power supply indicator. It is not possible to associate the low supply indication with any other outputs.

3.12 Walk Test Indicator ()

The walk test indicator signifies that at least one zone in the rack is set to the walk test mode. It is not possible to associate the walk test indication with any other outputs.

Note: The walk test condition is automatically cancelled if a fire condition occurs on any other zone in the system.

CHAPTER 3 CONTROLS AND FACILITIES

3.13 Individual Alarm

An individual alarm refers to an alarm resulting from an input or condition that occurs locally to the control card and that is not related to any other control card. Where appropriate the relevant indicator will illuminate on the control card.

3.14 Grouped (or Zoned) Alarm

A grouped alarm is caused in response to an individual alarm from any control zone within a designated group of zones. The relevant individual indicator will illuminate for the zone on the control card with the alarm, however, there are no visual indicators for the multi-card alarms on the fire card and it is therefore important to ensure the correct configuration and proper operation during commissioning.

3.15 Master Alarm

A master alarm is caused in response to any individual alarm from any control zone within the rack. The relevant individual indicator will illuminate for the zone on the control card with the alarm, however, there are no visual indicators for the multi-card alarms on the fire card and it is therefore important to ensure the correct configuration and proper operation during commissioning.

3.16 Voted Alarm

A voted alarm is caused by the simultaneous presence of an identical alarm from any control zone within a designated group of zones. The relevant individual indicator will illuminate for the zone on the control card with the alarm, however, there are no visual indicators for the multi-card alarms on the fire card and it is therefore important to ensure the correct configuration and proper operation during commissioning.

The operation of the voted alarm function, in response to fault and inhibit conditions on input zones within the designated group, can be modified by using vote compensation which is available as follows:

- a. No compensation.
- b. Faults counted as alarms.
- c. Faults and inhibits counted as alarms.
- d. Vote count reduction on faults.
- e. Vote count reduction on faults and alarms.

Vote compensation is useful to ensure that detectors in fault (or inhibit) do not prevent voted alarm outputs from occurring.

CHAPTER 3 CONTROLS AND FACILITIES

3.17 Latched Alarm

A latched alarm is an alarm that will remain active even though the level monitored is no longer in the alarm condition. The alarm indicator will remain illuminated until the alarm reset is operated. For highest integrity operation, the fire zones are permanently configured for latching operation.

3.18 Non-Latched Alarm

A non-latched alarm is an alarm that only remains active while the level being monitored is in the alarm condition. The alarm indicator will remain illuminated while the alarm condition remains but will be automatically reset as soon as the level monitored returns to the non alarm signal condition.

3.19 Normally Energised

A normally energised relay is activated when power is removed from it. This mode of operation is often used for fail-to-safe in the event of a system power failure. The status indicators will illuminate when an alarm or fault condition occurs irrespective of the relay configured state.

3.20 Normally De-Energised

A normally de-energised relay is activated when power is applied to it. The status indicators will illuminate when an alarm or fault condition occurs irrespective of the relay configured state.

4. FOUR CHANNEL FIRE CONTROL CARDS

4.1 General

The 5704F Four Channel Control Card provides the necessary power supplies to the associated detectors and conditions the incoming detector signals.

The received sensor signals are then processed by the microprocessor and the resultant values are constantly checked against the configured operational parameters. Any necessary alarm action is then carried out.

CHAPTER 3 CONTROLS AND FACILITIES

The fire card front panel can be subdivided into three areas:

- a. Front Panel Displays:
 - Zone Status Displays.
 - Fault Monitored Output Status Displays.
 - Card Status Displays.
- b. Front Panel Controls
 - Select Push-Button.
- c. Extraction Slot.

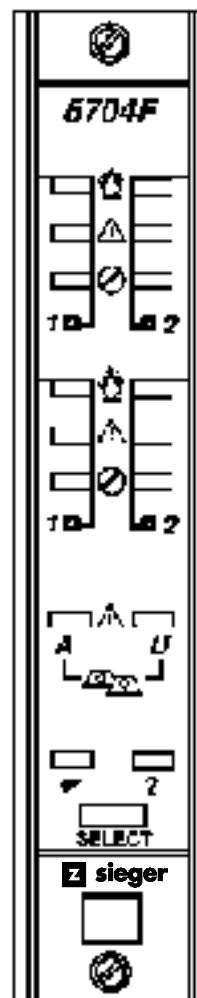

4.2 Front Panel Displays

4.2.1 General

The front panel has twenty LED indicator lamps. The function of each lamp is designated using a graphical symbol. A quick reference symbol key is provided by a label attached to the mounting flange of the rack.

The following sections identify the function of the indicators during normal operation. Immediately after power up the fire card performs a diagnostic self test during which the front panel indicators operate in a special sequence. The user should refer to Chapter 5 Section 5.1 for more details.

4.2.2 Zone Status Displays (1 - 4)

Each of the four zones has an identical set of four LED lamps that comprise the status display. On the front panel the zones are clearly numbered 1 to 4 and the indicator functions are designated using a graphical symbol. The symbols and LED indications are as follows:

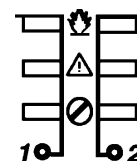

- a. Zone Fire LED (🔥)

A red indicator, flashing when the zone first enters the fire condition and changing to continuous illumination when the fire condition is acknowledged by pressing the accept push-button.

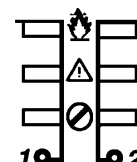

CHAPTER 3 CONTROLS AND FACILITIES

b. Zone Fault LED ()

A yellow indicator, flashing when the zone first enters the fault condition and changing to continuous illumination when the fault condition is acknowledged by pressing the accept push-button.

c. Inhibited Zone LED ()

A yellow indicator, illuminating continuously when the zone is in the inhibited state (ie. zone fault and alarm conditions are suppressed from causing output actuation). Flashes when the one man walk test mode is enabled for the zone.

d. Zone Select LED (**1 - 4**)

A small yellow indicator, illuminating continuously when the zone has been selected for use with engineering functions. During the power on self test all four zone select LEDs are illuminated continuously.

4.2.3 Fault Monitored Output Status Displays ()

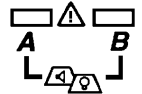

Each output has a single LED lamp status display. On the front panel the outputs are clearly numbered A and B and the indicator function is designated using a graphical symbol. The symbol and LED indication is as follows:

Output Fault LED ()

A yellow indicator, flashing when the output first enters the fault condition and changing to continuous illumination when the fault condition is acknowledged by pressing the accept push-button.

4.2.4 Card Status Displays

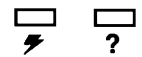

The card has two dedicated LED lamp status displays on the front panel. The indicator function is designated using a graphical symbol. The symbol and LED indication is as follows:

a. Power Supply LED ()

A green indicator, illuminated continuously when the card power supply voltage is within normal operating parameters. Flashes if a low supply condition is detected.

CHAPTER 3 CONTROLS AND FACILITIES

b. Card Fault LED (?)

A yellow indicator, with various modes of operation to indicate a number of different fault conditions:

- i. When illuminated continuously together with all zone select LEDs indicates power on self test in progress. Changes to flashing if the self test fails leaving a diagnostic code displayed on the other indicator lamps.
- ii. Slow flashing indicates earth leakage or remote input fault. Earth leakage can be identified by the simultaneous illumination of the earth leakage lamp on the Fire Status Panel. Changes to continuous illumination when the fault condition is acknowledged by pressing the accept push-button.
- iii. Fast flashing indicates a backplane communication failure or a continuous self test error indicating a serious non-input related hardware or software fault. This indication will remain on, even after a microprocessor reset, until manually cleared by an extended press of the cards select button.

4.3 Front Panel Controls



The fire card has a single front panel **SELECT** push-button which provides three functions depending upon how is operated:

a. Zone Select

The **SELECT** push-button, when pressed for approximately 1.5 seconds, selects the control card for operations controlled from either the Fire Status Panel or Engineering Card. Initially the Zone 1 select LED will illuminate. Other zones can be subsequently selected by the Engineering Card ▲ and ▼ keys.

b. Extended Fault Reset

When the card fault lamp is flashing quickly, indicating a backplane communication error, serious hardware or software fault on the control card, the **SELECT** push-button can be pressed continuously for five seconds to clear the error display and resume operation of the control card.

CHAPTER 3 CONTROLS AND FACILITIES

CAUTION

The card fault LED may indicate a serious fault on the card which should be investigated thoroughly and if necessary the control card should be replaced.

c. Channel De-select

The **SELECT** push-button, when pressed momentarily while any zone of the control card is selected, deselects the control card from the Fire Status and Engineering functions.

4.4 Extraction Slot

An extraction tool is used in conjunction with the extraction slot, just below the **SELECT** push-button, to remove the card from the rack. The extraction tool is provided as part of the key kit (05701-A-0550) supplied with each rack assembly.

The card is removed by first unscrewing the two securing screws, one at the top of the card and the other at the bottom of the card, and then hooking the extraction tool into the extraction slot and then gently pulling the card out of the rack.

WARNING

Under certain fault conditions some electrical components on the fire Control Card may become very hot. Take appropriate handling precautions and allow time for the card to cool before packing

4.5 Fire Card Facilities

The following paragraphs provide an overview of the various facilities provided by the fire control card.

4.5.1 Fire Zone Inputs

The fire zone inputs generate the necessary signals to drive four independent fire detection circuits. Each zone is powered from the system dc supply but voltage limited to +24V maximum to protect the detectors. The zone supply is not isolated from the system 0V. Depending upon cable length each zone is capable of supporting up to 20 low quiescent detectors and almost unlimited manual call points. Every zone is monitored for four operating conditions and each has a configurable signal band. The zone conditions and default signal bands are as follows:

CHAPTER 3 CONTROLS AND FACILITIES

OPEN CIRCUIT FAULT	0mA - 3mA
NORMAL OPERATION	3mA - 10mA
FIRE ALARM	10mA - 30mA
SHORT CIRCUIT FAULT	30mA - 50mA (and above)

The fire, inhibit and fault status information generated from the operating conditions is used locally for display and actuation, and also broadcast to the other fire controller cards in the rack.

Each zone must be electrically terminated by connecting an appropriate resistance at the end of the line. The nominal end of line resistance is 5.6k ohms and the maximum short circuit current is approximately 50mA. The inputs are hardware link selectable for compatibility with external barriers or galvanic isolators for intrinsically safe applications.

The operating status of the zones are affected by the fire status panel reset button and card remote reset input. During reset the power to each zone will be switched off for five seconds.

It is possible to individually inhibit the zones. When inhibited the fire and fault conditions are still displayed visually on the individual zone indicators but are suppressed in any local or multi-card output functions and from the common fire status panel indication.

4.5.2 Switched DC Outputs

IMPORTANT

The output is reversed biased during the inactive state to facilitate monitoring for fault conditions. Any equipment to be connected to the output must therefore have built in polarity protection or be provided with a separate series diode

The output circuitry generates the necessary signals to drive two independent dc outputs. Each output circuit is powered from the system dc power supply and fused to 1A maximum. The outputs are not isolated from the system 0V. The outputs are suitable for switching lamps, sounders, relays etc.

CHAPTER 3 CONTROLS AND FACILITIES

CAUTION

The maximum backplane current capacity of 8A must not be exceeded. Provision is made for the individual powering of each fire controller card when required.

While switched off, each output is monitored for short circuit and open circuit faults to ensure that the output is capable of operating when required. When switched on, the output is monitored for fuse failure. The fault status information is used locally for display and actuation and also broadcast to the other fire controller cards in the rack.

The configuration allows the activation of each output to be independently associated with the operating status of one or more of the local fire zones (fire, inhibit and fault), the product of a multi-card alarm function (eg. master, grouped or voted alarms) and/or the card fault condition. When activated each output will operate continuously until the relevant status condition(s) have cleared. In addition, each output is independently configurable to respond to the silence condition which may be generated via the fire status panel Silence control or the cards remote silence input. A silence enabled output will deactivate immediately upon operating the silence push-button regardless of input status. By default each output is associated with all four fire local zones and silence response is enabled.

Each output must be electrically terminated with a nominal end of line resistance of 22k ohms.

4.5.3 Voltage Free Contact Outputs

There are two options for voltage free contacts. The standard Hex Relay Card provides six relay outputs, while the 5704F Relay Interface Assembly provides sixteen relay outputs. For relay ratings see Chapter 7 Section 5.

The configuration allows the activation of each relay to be independently associated with the operating status of one or more of the local fire zones (fire, inhibit and fault), the product of a multi-card alarm function (eg. master, grouped or voted alarms) and/or the card fault condition. When activated each relay will operate continuously until the relevant status condition(s) have cleared. The operation of each relay is individually configurable for normally energised or normally de-energised operation. In addition, each relay is independently configurable to respond to the silence condition which is generated via the fire status panel Silence control or the cards remote silence input. A silence enabled relay will deactivate immediately upon the silence condition regardless of input status.

CHAPTER 3 CONTROLS AND FACILITIES

The default function of each relay and its non alarm operating state are as follows:

Relay 1	Master Fault for Card (including Card Fault)	Normally energised.
Relay 2	Master Inhibit for Card	Normally de-energised.
Relay 3	Zone 1 Fire	Normally de-energised.
Relay 4	Zone 2 Fire	Normally de-energised.
Relay 5	Zone 3 Fire	Normally de-energised.
Relay 6	Zone 4 Fire	Normally de-energised

The silence response is enabled by default on relays associated with fire conditions.

For the configuration of the relays on the 5704F Relay Interface Assembly refer to the configuration printout supplied with all new systems.

4.5.4 Remote Inputs

To reduce the number of terminal blocks required, the fire card has a single remote input connection that supports three functions - Accept, Reset and Silence. When required, one of the three functions is selected by applying a specific value of resistance onto the remote input. The remote input is fault monitored for open and short circuits and therefore must be electrically terminated with a nominal end of line resistance of 22k ohms. The remote input functions with their nominal resistance values, in order of highest priority, are as follows:

Remote Accept (10k) A momentary action input causing all previously unaccepted fire and fault conditions into the accepted state.

Remote Reset (4.7k) A momentary action input causing a reset of all inputs and outputs, clearing latched fire alarm and fault conditions etc.

Remote Silence (2.2k) A momentary action input forcing all silence enabled output channels to the inactive condition.

It should be noted that with the remote reset and silence functions it is necessary to accept fire alarm and fault conditions before initiating the function. In addition, the remote input functions are not subject to access level restrictions in the same way as the Fire Status Panel functions. If this is required it must be facilitated by external means (eg. key switches). It is not permitted to operate more than one remote input at a time.

CHAPTER 3 CONTROLS AND FACILITIES

The remote input to the Fire Control Card connected to the Fire Status Panel operates as a common input for the whole rack. The remote input of all other Fire Control Cards, operates only locally on the associated individual card.

4.5.5 Earth Leakage Detection

IMPORTANT

Although each card is equipped with the earth leakage detection circuit it is important that the enabling link is set on one card only, usually the card connected to the Fire Status Panel.

The earth leakage detection operates between the system dc power supply applied to the rack and the chassis (EMC) ground. For the earth leakage detection circuit to operate correctly it is essential the system dc supply outputs (+24V and 0V) are isolated from ground (the System 57 power supplies meet this requirement). The earth leakage detection circuit must be enabled by setting the appropriate link on the fire card. By default the earth leakage fault condition is configured to be output on the card general fault relay.

4.5.6 Supply Monitor

The 24V supply is continuously monitored for over and under range voltage conditions. When a supply fault is detected a card fault condition is generated. If the supply falls too low then the fire zones will also indicate fault.

4.5.7 Fire Counters

A fire counter for each fire zone is retained in semipermanent memory by the fire card. The count is incremented by one for every alarm condition on the respective zone. The time and date of the last alarm is also recorded. One man walk test does not affect the count value or time stamp. The fire counters are only available via the Engineering Card printout facility. The counter can only be reset using the Engineering Interface Software.

4.5.8 Multi-Card Alarm Facilities

The System 57 multi-card alarm philosophy is fully supported allowing a master, grouped or voted alarm function to be defined on the fire card. The results of the multi-card alarm function can be associated with both relay and/or switched output circuits on that card. The multi-card alarm function uses alarm information from individual zones/channels on one or more Fire and/or Gas control cards. The following status information can be processed in a multi-card alarm function:

CHAPTER 3 CONTROLS AND FACILITIES

Sensor Fault	Status available from participating zones/channels.
Inhibit	Status available from participating zones/ channels.
Output Fault	Status available from participating fire cards only.
Silence	Status available from participating fire cards only.
Fire	Status available from participating fire zones only.
A1	Status available from participating gas input channels only.
A2	Status available from participating gas input channels only.
A3	Status available from participating gas input channels only.

It is possible to set a vote count between 1 and the number of participating zones/channels for the Fire, A1, A2 and A3 event categories. Vote compensation methods are also available as follows:

- Sensor Faults counted as alarms.
- Sensor Faults and Inhibits counted as alarms.
- Vote Count Reduction on Sensor Faults.
- Vote Count Reduction on Sensor Faults and Inhibits.

For any zone/channel that is inhibited the alarm and sensor fault status of that zone/channel will be excluded when calculating the multi-card alarm result.

For any zone/channel that is in sensor fault the alarm status of that channel will be excluded when calculating the multi-card alarm result.

In the event of a backplane communications error from a card that is participant of a multi-card alarm function all channels on that card will be treated as being in the sensor fault state as detailed above. The fire card hosting the multi-card alarm function will also signal communications error on the call engineer indicator lamp.

4.5.9 Access Levels

To protect against unauthorised adjustments and tampering the various controls can be subject to restricted access. There are four access levels designated AL1 to AL4. AL1 is the lowest access level for functions that are available at all times without a key or other device. AL2 requires the

CHAPTER 3 CONTROLS AND FACILITIES

use of the Engineering Key. AL3 is only accessible using the Engineering Interface Software and AL4 is a special factory mode. The access level for certain functions is configurable. The access levels, modes of protection and default functions are summarised below:

Access Level	Mode	Typical Function (Default)
AL1	Open access.	Lamp Test, Accept, Reset, Silence.
AL2	Engineering Key fitted.	Inhibit, Walk Test.
AL3	Engineering Interface Software	User configuration.
AL4	Factory Mode.	Fire counter reset and low level configuration.

5. FIRE STATUS PANEL

5.1 General

The 5704FS Fire Status Panel provides the additional specialised user controls and audible/visual indicators that are necessary for a fire control system. One common Fire Status Panel is required in every rack. The Fire Status Panel is located immediately to the right of one fire card to which it connects via a short flying lead.

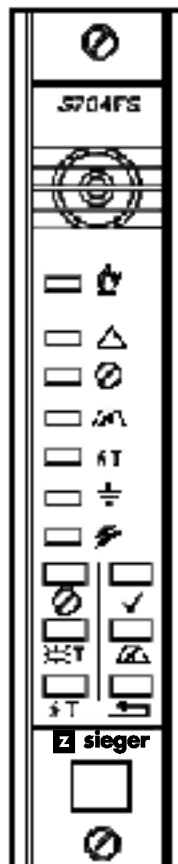

The status panel has LED indicators to give a clear global status indication for all of the fire control cards fitted into the rack, together with an audible alert sounder and six push-button controls. The status panel is controlled by the microprocessor on the adjacent fire card, it can not operate independently and has no intelligence of its own.

The Fire Status Panel front panel can be subdivided into four areas:

- Audible Alert Sounder.
- Common Status Indicators.
- User Controls.
- Extraction Slot.

CHAPTER 3 CONTROLS AND FACILITIES

5.2 Front Panel Displays

5.2.1 General

The Fire Status Panel front panel has seven LED indicator lamps. The LED indicators give clear global status indication for all of the fire control cards fitted into the rack. The function of each lamp is designated using a graphical symbol. A quick reference symbol key is provided by a label attached to the mounting flange of the rack. The function of the indicators are as follows:

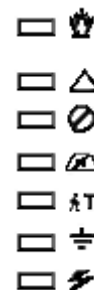

5.2.2 Common Fire LED (🔥)

A red indicator, flashing when any non-inhibited input zone in the rack enters the fire alarm condition. Changes to continuous illumination when the fire condition is acknowledged by pressing the accept push-button.

5.2.3 Common Fault LED (⚠)

A yellow indicator, flashing when any non-inhibited input zone in the rack enters the fault condition. Changes to continuous illumination when the fault condition is acknowledged by pressing the accept push-button.

5.2.4 Common Inhibit LED (🚫)

A yellow indicator, illuminating continuously when any zone in the rack is in the inhibited state (ie. zone fault and alarm conditions are suppressed from causing output actuation).

5.2.5 Output Silenced LED (🔇)

A yellow indicator, illuminating continuously when any output circuit or relay in the rack is in the silenced condition.

Note: The silence condition is automatically cancelled if a new fire condition occurs on any zone in the system.

5.2.6 Walk Test Active (🚶)

A yellow indicator, illuminating continuously when any zone in the rack is in one man walk test mode.

Note: The walk test condition is automatically cancelled if a fire condition occurs on any other zone in the system.

CHAPTER 3 CONTROLS AND FACILITIES

5.2.7 System Earth Fault (⚡)

A yellow indicator, flashing when a new earth fault condition is detected. Changes to continuous illumination when the earth fault condition is acknowledged by pressing the accept push-button.

5.2.8 Panel Power LED (⚡)

A green indicator, illuminated continuously while power is applied to the Fire Status Panel.

Note: This indicator does not flash during a low supply condition.

5.3 Front Panel Audible Alert

The Fire Status Panel is fitted with a single audible sounder. The audible alert is designed to draw attention to the fire system when a fire and/or fault conditions occur. The status panel and remote input ACCEPT functions can be used to acknowledge the various alert conditions thereby muting the audible alert signal while those conditions still exist. The audible output has various modes of operation, in order of highest priority, as follows.



a. New Fire

The audible alert signal will trigger into the continuous sound output mode when any non-inhibited fire zone on any Fire Control Card in the rack enters the alarm condition.

b. New Fault

The audible alert signal will trigger into a 1Hz on/off pulsed sound output mode when any fault condition occurs on any Fire Control Card in the rack.

c. Accepted Fire

If the audible alert signal is **ACCEPTED** while any non-inhibited fire conditions exist on any zone within the rack, the accepted fire mode will be entered. By default the accepted fire mode will provide an intermittent sound output of one second duration every 10 seconds.

Note: It is possible to configure the audible output to be off in the accepted fire mode.

CHAPTER 3 CONTROLS AND FACILITIES

d. Accepted Fault

If the audible alert signal is **ACCEPTED** while any non-inhibited fault conditions exist on any Fire Control Card within the rack, the accepted fault mode will be entered. By default the accepted fault mode will provide an intermittent sound output of 1 second duration every 30 seconds.

Note: It is possible to configure the audible output to be off in the accepted fault mode.

When in the **ACCEPTED** mode, the audible alert signal will resound for any new fire alarm or fault condition that is detected.

Note: It is also possible to configure the audible alert to resound automatically from the accepted condition after 24 hours have elapsed. Provided the fire or fault condition still persists, it will resound in the either the appropriate fire or fault mode.

5.4 Front Panel Controls

5.4.1 General

The Fire Status Panel has six momentary action push-button switches for user operations. The front panel controls can be divided into two types, those that operate across all fire cards in the rack and those that operate on a single zone only. Single zone functions require that a zone on one fire card is selected before pressing the status panel button.

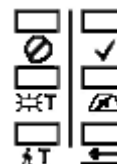

5.4.2 User Controls for Multi-Card Functions:

The following buttons initiate functions that operate across all Fire Control Cards in the rack:

a. Accept



When pressed, causes the accept condition to be sent to all fire zones in the rack. All unaccepted fire and fault conditions (flashing lamp indication) will become accepted (steady lamp indication). The status panel audible alert sounder will also enter the appropriate accepted mode.

Note: The accept function may be configured to require, or not require, the presence of the Engineering Key before an accept operation can be performed. By default the Engineering Key will not be required.

CHAPTER 3 CONTROLS AND FACILITIES

b. Silence



When pressed, causes the silence condition to be sent to all Fire Control Cards in the rack. All output circuits and relays configured to respond to the silence command will be suppressed.

Note: The silence function may be configured to require, or not require, the presence of the Engineering Key before a silence operation can be performed. By default the Engineering Key will not be required.

c. Reset



When pressed, causes the reset condition to be sent to all Fire Control Cards in the rack. All fire zones will perform the reset activity, isolating the supply for five seconds.

Note: The reset function operation may be configured to require, or not require, the presence of the Engineering Key before a reset operation can be performed. By default the Engineering Key will not be required.

d. Lamp Test



When pressed, causes the lamp test condition to be sent to all Fire Control Cards in the rack. All front panel indicator lamps on all cards will become illuminated simultaneously and continuously for five seconds before returning to the previous operating state. The lamp test function does not require the presence of the Engineering Key.

IMPORTANT

It should be noted that with the reset and silence functions it is necessary to accept fire alarm and fault conditions before initiating the function.

5.4.3 User Controls for Zone Functions

In common with other System 57 control cards, a SELECT switch is provided on the Fire Control Card front panel. This enables a zone on the card to be used in conjunction with the Fire Status Panel keypad and Engineering Card. Once selected the Engineering Card ▲ and ▼ keys can be used to select an individual zone on the fire card. The following zone functions are provided:

a. Walk Test



When pressed, toggles the selected zone in/out of the one man walk test mode. During the one man walk test the zone inhibited lamp flashes and whenever the zone enters alarm it will be automatically reset after five seconds.

CHAPTER 3 CONTROLS AND FACILITIES

WARNING

Fire conditions generated during walk test will cause the switched and voltage free outputs associated with this zone to be activated for at least five seconds.

Note: The Engineering Key must be fitted before this function can be initiated and is NOT cancelled by removal of the Engineering Key.

b. Inhibit



When pressed, toggles the selected zone between the non-inhibit state and the inhibit condition. When inhibited, the fire and fault conditions are displayed visually on the individual channel indicators but are suppressed in any local or multi-card output function, and from the common fire status panel indication. When the inhibit condition is switched off an automatic reset condition will occur on the selected zone.

Note: The Engineering Key must be fitted before this function can be initiated and is NOT cancelled by removal of the Engineering Key.

c. ▲ or ▼

When used individually, changes the selected zone on the selected fire card.

d. ▲ and ▼

When both ▲ and ▼ are pressed at the same time, prints the selected cards configuration details via the Engineering Card front panel serial port.

A summary of Fire Status Panel controls, maintenance functions and remote inputs is given in Table 1.





5.5 Extraction Slot

An extraction tool is provided as part of the Key kit (05701-A-0550) supplied with each rack assembly. This is used in conjunction with the extraction slot, just below the **SELECT** push-button, to remove the card from the rack.

The card is removed by first unscrewing the two securing screws, one at the top of the card and the other at the bottom of the card. The extraction tool is then hooked into the extraction slot and the card gently pulled out of the rack.

CHAPTER 3 CONTROLS AND FACILITIES

Table 1 Summary of Fire Control Card Visual Indicator Functionality

Designation	Symbol	Colour	Indications	
			Continuous	Flashing
Zone Fire		Red	Fire (accepted).	Fire (not accepted).
Zone Inhibit		Yellow	Inhibited.	One man walk test.
Zone Fault		Yellow	Fault.	Fault (not accepted).
Output Fault		Yellow	Fault.	Fault (not accepted).
Zone Select	1 - 4	Yellow	Channel Selected.	-
Power		Green	Normal.	Low Supply.
Card Fault (Normal operation)	?	Yellow	Accepted earth leakage or remote input fault condition.	Slow flash: earth leakage or remote input fault. Fast flash: backplane communications error or self test failure.
Card Fault (At power up)	?	Yellow	With all zone select LEDs: power up test in progress	With all zone select LEDs: power up test failure.

CHAPTER 3 CONTROLS AND FACILITIES

Table 2 Summary of Fire Status Panel Visual Indicator Functionality



















Visual Indicator	Symbol	Colour	Indications	
			Continuous	Flashing
Master Fire		Red	Fire signal on at least one zone (accepted).	New fire condition (not accepted).
Master Fault		Yellow	Fault signal on at least one zone or switched output (accepted).	New fault condition (not accepted).
Master Inhibit		Yellow	At least one zone inhibited.	-
Master Silence		Yellow	At least one output silenced.	-
Master Walk		Yellow	At least one zone in walk test mode.	-
Earth Fault		Yellow	Earth Fault present (accepted).	New Earth Fault (not accepted).
Power		Green	Normal	

Table 3 Summary of Fire Status Panel Audible Indicator Functionality

Audible Mode	Indication
Continuous	New fire condition (not accepted).
1 second ON, 1 second OFF.	New fault condition (not accepted).
1 second ON every 10 seconds.	Fire signal on at least one zone (accepted) .
1 second ON every 30 seconds.	Fault signal on at least one zone (accepted).

CHAPTER 3 CONTROLS AND FACILITIES

Table 4: Summary of User Controls, Maintenance Functions and Remote Inputs

Designation	Card Status	
	Not Selected	Channel x Selected
 (FC)	More than 1.5 seconds selects fire card. More than 5 seconds resets the card fault indicator.	Deselects fire card.
 or  (EC)	-	Changes the designated zone on the selected card.
 and  (EC)	-	Prints a card configuration report via the Engineering Card port.
 Lamp Test (FSP)	Illuminates all front panel indicator lamps on all cards including the Fire Status Panel.	Illuminates all front panel indicator lamps on all cards including the Fire Status Panel.
 Walk Test (FSP)	-	Places the selected zone into the one man walk test mode (alarms automatically reset after 5 seconds).
 Inhibit (FSP)	-	Places the selected zone into the inhibit condition.
 Accept (FSP)	Sends the accept command to all Fire Control Cards and accepts the Fire Status Panel audible alert sounder.	
 Silence (FSP)	Sends the silence command to all Fire Control Cards.	
 Reset (FSP)	Sends the reset command to all Fire Control Cards.	
Accept (REM)	Causes a card accept condition (and optionally sends the accept command to all Fire Control Cards).	
Reset (REM)	Causes a card reset condition (and optionally sends the reset command to all Fire Control Cards).	
Silence (REM)	Causes a card silence condition (and optionally sends the silence command to all Fire Control Cards).	

Key: EC - Engineering Card, FC - Fire Card, FSP - Fire Status Panel, REM - Remote Input

CHAPTER 3 CONTROLS AND FACILITIES

6. ENGINEERING CARD

6.1 General

The Engineering Card provides facilities to allow each control card channel to be interrogated and to allow normal maintenance functions such as calibration to be carried out. It also acts as a connecting point for the engineering interface software which allows each card to be configured.

6.2 LED Indicators

Two indicators at the top of the front panel of the Engineering Card indicate the operational status of the card:

6.2.1 ⚡ - Green LED

A continuously illuminated LED indicates that the correct dc power is connected to the rack via the DC Input Card.

A flashing LED at approximately two second intervals, indicates a low dc power input level.

A flashing LED at approximately 0.5 second intervals, indicates a hardware fault.

6.2.2 🔒 - Red LED

Provides an indication of the operation of the Engineering Card communications status as follows:

- Off: Engineering Card functioning correctly and the engineering functions are locked. Operators functions are operational to allow the checking of various control card channel settings.
- On: Engineering Card functioning correctly and the engineering functions are unlocked enabling changes to be made to the operation of a selected control card channel.

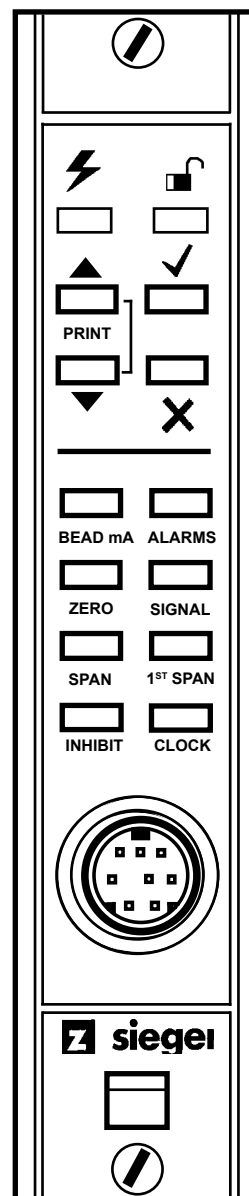

CHAPTER 3 CONTROLS AND FACILITIES

Flashing: Indicates that a control card has been withdrawn from the rack, there is a communications error or that an external PC running the engineering interface software is communicating with the control cards.

Note: To reset the indication, insert the Engineering Key momentarily and then remove again.

6.3 Engineering Push-buttons

6.3.1 General

The Engineering Card push-buttons control various functions depending on the type of control card fitted and whether the Engineering Key is fitted.

6.3.2 Up Push-button (▲)

When the up push-button (▲) is operated, it increases the value of those functions that can be adjusted. With no engineering functions selected, this push-button is used to select a particular channel of a selected control card.

6.3.3 Down Push-button (▼)

When the down push-button (▼) is operated, it decreases the value of those functions that can be adjusted. With no engineering functions selected, this push-button is used to select a particular channel of a selected control card.

6.3.4 Operation of the Up and Down Push-buttons Simultaneously

This operation can only be used if a serial printer is connected to the rack. When the up (▲) and down (▼) push-buttons are operated simultaneously a print out command is selected of the control card configuration and status.

6.3.5 Accept Push-button (✓) - Gas Cards Only

When the accept push-button (✓) is operated during any of the engineers functions, this button confirms adjustments that have been made and then cancels that function.

CHAPTER 3 CONTROLS AND FACILITIES

6.3.6 Reject Push-button (X)

When operated during any of the engineers functions and providing the accept (✓) push-button has not been operated, the reject push-button (X) cancels adjustments that have been made. This push-button is also used to de-select a selected function and for manual channel display selections.

6.3.7 BEAD mA Push-button - Gas Cards Only

When the **BEAD mA** push-button is operated, the display of the selected Catalytic Control Card provides an indication of the selected channels sensor head current.

Adjustments to this current can also be made if the Engineering Key is fitted to the Engineering Card.

6.3.8 ALARMS Push-button - Gas Cards Only

When the **ALARMS** push-button is operated, the display of the selected control card provides an indication of the selected channels level and type (rising or falling) of each alarm level (A1, A2, A3), and the STEL/ LTEL levels

If the Engineering Key is fitted to the Engineering Card, adjustments can be made to the alarm levels, within pre-defined limits, and additional test facilities become available. This facility allows each alarm operation to be checked and, if required, its associated output relay to be exercised.

6.3.9 SIGNAL Push-button - Gas Cards Only

When the **SIGNAL** push-button is operated, the display of the selected control card provides an indication of the selected channels sensor signal as follows:

- a. 4 - 20mA Control Card - Loop current in mA.
- b. Catalytic Control Card - Catalytic bridge output (sensitivity) in mV.

6.3.10 ZERO Push-button - Gas Cards Only

The **ZERO** push-button can only be used when the Engineering Key is fitted to the Engineering Card and is used to calibrate the zero point of the selected control card channel.

CHAPTER 3 CONTROLS AND FACILITIES

6.3.11 SPAN Push-button - Gas Cards Only

The **SPAN** push-button can only be used when the Engineering Key is fitted to the Engineering Card and is used to calibrate the span point of the selected control card channel.

6.3.12 1ST SPAN Push-button - Gas Cards Only

The **1ST SPAN** push-button can only be used when the Engineering Key is fitted to the Engineering Card and is used to calibrate the span point of a new catalytic sensor fitted to a selected catalytic control card channel.

This function is used to provide an indication, in conjunction with subsequent normal span adjustments, of the output sensitivity of a catalytic sensor and to automatically indicate poisoning or loss of sensor performance.

6.3.13 CLOCK Push-button - Gas Cards Only

When the **CLOCK** push-button is operated, the display of the selected control card provides an indication of the time and date of the rack clock.

The rack clock is located in the Engineering Card, however since the Engineering Card has no display, a control card must be selected to enable the time and date to be displayed. It does not matter which control card or channel is selected.

If the Engineering Key is fitted to the Engineering Card, the time and date can be adjusted.

6.3.14 INHIBIT Push-button - Gas Cards Only

When the **INHIBIT** push-button is operated, the selected control card channel is placed in the inhibit mode. This prevents the operation of any configured relay output alarm functions.

Inhibit can only be used if the Engineering Key is fitted to the Engineering Card, however, if the Engineering Key is subsequently removed the selected control card channel remains in the inhibit mode.

6.4 Engineering Serial Port - Gas Cards Only

The Engineering Serial Port is a miniature DIN socket which provides three functions:

- a. Connection point for the Engineering Key to unlock the engineers functions.

CHAPTER 3 CONTROLS AND FACILITIES

- b. Connection point for the External Engineering Interface which allows each control card to be configured by an external PC running the engineering interface configuration software.
- c. Connection point for a serial printer which can be used to provide a hard copy of the control card configuration data and status.

The Engineering Serial Port and its Engineering Key are shown below:

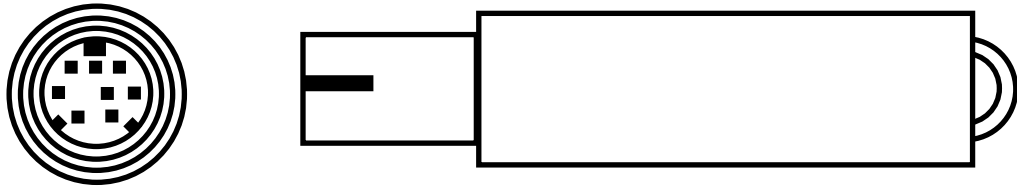

CHAPTER 4 INSTALLATION INSTRUCTIONS

5704F SERIES CONTROL SYSTEM CHAPTER 4 INSTALLATION INSTRUCTIONS

CHAPTER 4 INSTALLATION INSTRUCTIONS



WARNING

For installations in the UK the following codes are highly recommended:

BS 5839: 1988 Fire Detection and Alarm Systems for Buildings
- Code of Practice for System Design, Installation and Servicing.

BS 7671 Requirements for Electrical Installation - IEE Wiring
Regulations, Sixteenth Edition.

In North America the following code of practice is recommended:

NFPA 72 National Fire Alarm Code 1996 Edition.

For other areas the appropriate local or national regulations should be used.

IMPORTANT NOTICES

1. Honeywell Analytics can take no responsibility for installation and/or use of its equipment if this is not done in accordance with the appropriate issue and/or amendment of the manual.
2. The user of this manual should ensure that it is appropriate in all details to the exact equipment to be installed and/or operated. If in doubt, the user should contact Honeywell Analytics for advice.
3. The System 57 cards contain no user serviceable parts except switched output fuses. Refer all servicing to qualified service personnel.
4. Use only Honeywell Analytics approved parts and accessories. Use of non-approved parts may affect performance.

CHAPTER 4 INSTALLATION INSTRUCTIONS

CONTENTS		
Section		Page
1.	INTRODUCTION	4-5
2.	UNPACKING	4-5
3.	LOCATION	4-6
4.	CABLING	4-7
5.	POWER REQUIREMENTS	4-7
6.	VENTILATION	4-9
7.	PRELIMINARIES	4-9
8.	CABINET INSTALLATION	4-9
9.	PANEL INSTALLATION	4-12
10.	RACK INSTALLATION	4-14
11.	SENSOR INSTALLATION	4-15
11.1	General	4-15
11.2	Compatible Detector Types	4-16
11.3	Fire Input Circuit Topology	4-17
11.4	Line Resistance	4-18
11.5	Number of Detectors Versus Line Resistance	4-18
11.6	Separately Powered Detectors	4-20
11.7	Cable Resistance Guide	4-21
12.	DETECTOR CONNECTIONS	4-22
12.1	General	4-22
12.2	Typical Loop Powered Connections	4-22
12.3	Typical Loop Powered Detector with IS Barrier Connections	4-25
12.4	Separately powered Detectors	4-27
12.5	Call points and Simple Switched Output Detectors	4-29
12.6	Detectors With Voltage Free Contact Outputs	4-31
13.	OUTPUTS	4-33
13.1	Output Types	4-33
13.2	Switched Outputs	4-33
13.3	Switched Outputs With Boost Circuit	4-35
13.4	Relay Outputs	4-36

CHAPTER 4 INSTALLATION INSTRUCTIONS

14. REMOTE INPUT CONNECTIONS	4-37
15. DC POWER CONNECTIONS	4-38
15.1 General	4-38
15.2 Individually Powered Control Cards	4-39
16. AC TO DC POWER SUPPLY UNIT CONNECTIONS	4-40
17. UPGRADING THE AC TO DC POWER SUPPLY UNITS	4-42
17.1 General	4-42
17.2 8-Way and 16-Way AC to DC Power Supply Unit Upgrade to 100W	4-45
17.3 16-Way AC to DC Power Supply Unit Upgrade to 150W or 200W	4-46

TABLES

Table	Page
1 Power Budget Calculation Sheet	4-8

CHAPTER 4 INSTALLATION INSTRUCTIONS

1. INTRODUCTION

A summary of the System 57 controller installation procedures is shown below:

- (1) Unpack and check the equipment.
- (2) Identify a suitable location for the control system and check the cabling requirements.
- (3) Confirm the power supply requirements.
- (4) Install the Cabinet, 19" Mounting Frame or Panel Cutout as required.
- (5) Fit the System 57 rack into the Cabinet, 19" Mounting Frame or Panel Cutout as required.
- (6) Install the detectors, call points, etc. and wire back to the System 57.
- (7) Check, and if necessary reconfigure, the Fire Control Cards.
- (8) Wire the sensors to the relevant Relay Interface Card terminal blocks.
- (9) Wire the relay and switched outputs from the Hex Relay Interface Card or Fire Relay Interface Assembly if used.
- (10) Wire the remote inputs from the relevant Relay Interface Card terminal blocks.
- (11) Wire the power supply to the DC Input Card. In individually powered applications, wire the power supply to each Hex Relay Interface Card and set the power distribution link on the Fire Control Card accordingly.
- (12) Wire the power supply ac input to the to a suitable supply. DO NOT SWITCH ON AT THIS TIME.

After installation is complete perform the commissioning procedures outlined in Chapter 5.

The following sections of this chapter provide a detailed explanation of the installation operations.

2. UNPACKING

On receipt:

- a. Carefully unpack the equipment observing any instructions printed on or contained in the packaging.

CHAPTER 4 INSTALLATION INSTRUCTIONS

- b. Check the contents for transit damage and against the packing note for deficiencies.
- c. Locate the configuration sheet supplied with the unit and confirm that each channel card type and settings are compatible with the proposed sensors.

3. LOCATION

The control system must be installed in a safe area such as a control or equipment room, away from sources of heat, with adequate ventilation and protected from the weather.

There are two different System 57 rack configurations to accommodate either front or rear field wiring entry. Each configuration is available in half or full 19" width. The three most common mounting methods are:

- a. 19" Mounting Frame

The System 57 19" 6U front and 3U rear access racks are compatible with the standard 19" (483mm) sub-rack format and may therefore be fitted into any suitable 19" mounting frame.

- b. Cabinet

Wall mounting cabinets are available in two sizes to accommodate the 19" and half 19" 6U front access rack assemblies.

- c. Panel

Alternatively all the racks are suitable for fitting directly into a panel cutout aperture.

Power supply units are available, in both 19" and half 19" 1U formats, for applications where an ac input power source is to be used. It is recommended that the power supply units are mounted directly above the System 57 rack.



CAUTION

3U rear access racks should always be supported at the rear of the unit to prevent distortion and excessive loading of the front flange plates.

CHAPTER 4 INSTALLATION INSTRUCTIONS

4. CABLING

The field terminals on the Hex Relay Interface and Fire Relay Interface Assembly accept single or multi-stranded wire up to 2.5mm² (14 AWG). Cables should be routed carefully to avoid physical and environmental hazards such as mechanical stress and high temperatures.

Detector wiring should consist of a cable with an earthed outer shield and should be routed away from sources of interference such as ac power cables, motors, machinery etc. All detector cabling is subject to a maximum cable length that is dependant upon the cable line resistance and sensor types.

The current ratings of the power and relay cables should always be higher than the worst case maximum load requirement.

All detector field cables must be screened in order to ensure correct operation of the system and to meet European Standards for RFI and EMC. The cable screen of each detector should be connected to a GROUND terminal at the cabinet entry or the ground terminal of the appropriate Hex Relay Interface Card or another suitable ground point.

5. POWER REQUIREMENTS

The System 57 operates from a nominal 24V (21V to 32V) dc power supply input which may be derived from various sources including the mains ac, via a separate ac to dc power supply unit, local plant dc supply and/or battery backup dc supply.

The power supply may be applied to the System 57 backplane, via the DC Input Card, where the maximum backplane current is limited to 8A. The DC Input Card terminal blocks allow flexible power connections and diode isolation for two separate power supply inputs.

Where the number of Control Cards fitted and the type of detector or output device used would cause a backplane current in excess of the 8A maximum, it is necessary to connect the power supply to each individual control card via its Interface Card.

See Section 15.2 for connection details.

The power supply rating required is dependent upon the detector types, number of channels and configuration of the System 57. Table 1, the Power Budget Calculation Sheet, allows for a quick and easy calculation of the worst case power requirement for the system. In many cases a lower power rating can be used, however, a more detailed power budget analysis should be performed to confirm the exact requirement.

CHAPTER 4 INSTALLATION INSTRUCTIONS

Table 1 Power Budget Calculation Sheet

To calculate the power requirement:

- (1) Enter the number of devices of each type used in the system in column B.
- (2) Multiply by the unit power shown in column C.
- (3) Enter the result in column D.
- (4) Add up column D to calculate the total power required.

Device or Sensor Type in Rack	Number Requirement (W)	Unit Power (W)	Total
A	B	x C	= D
System 57 DEVICES:			
Four Channel Fire Card, (includes conventional detector signal)	_____	8.5	_____
Fire Status Panel	1	0.9	0.9
Engineering Card	1	1.5	1.5
DC Input Card	1	0	0
Modbus Interface 232	_____	0.75	_____
Modbus Interface 422/485	_____	1.50	_____
Event Printing	_____	0.75	_____
Alarm Update	_____	0.25	_____
Update Panel	_____	0.20	_____
Hex Relay Interface Card*	_____	2.4	_____
Fire Relay Interface Assembly*	_____	7.0	_____
ALLOWANCE FOR DETECTOR AND OUTPUT DEVICES POWERED FROM SYSTEM 57 PSU:			
SearchFlame 22**	_____	3.0	_____
SearchFlame 16	_____	2.8	_____
Stratos HSSD	_____	15.0	_____
Stratos Quadra	_____	25.0	_____
Conventional Smoke	_____	0	0
Conventional Heat	_____	0	0
Conventional Manual Call Point (MAC)	_____	0	0
Others (refer to manufacturers data for column (C))	_____	x	_____
TOTAL SYSTEM POWER REQUIREMENT		=	W

* All relays energised.

** Maximum supply voltage 28V dc.

CHAPTER 4 INSTALLATION INSTRUCTIONS

The 8-Way AC to DC Power Supply Units can provide a 50W dc supply or a 100W dc supply depending upon whether one or two switch mode modules are incorporated in the power supply unit.

Similarly, the 16-Way AC to DC Power Supply Units can provide a 50W, 100W, 150W and 200W dc supplies depending upon whether one, two, three or four switch mode modules are incorporated in the power supply unit.

6. VENTILATION

The System 57 Control System provides the facility for a large number of channels in a very small space. In heavily populated racks, especially those with many catalytic input control cards or relays configured for normally energised operation, it is possible for the heat dissipation to cause a significant rise in temperature both within the rack and in an area close to the rack.

As such, careful consideration must be given to thermal planning. To achieve most from the convection cooling, always ensure that the air can flow freely through the rack and power supply. Do not obstruct the air vent holes in the top and bottom of the rack and if possible space the control cards evenly within the rack.

It is recommended that during commissioning the operating temperature of the rack is checked to ensure that the maximum operating temperature of 55°C is not exceeded. In some cases the addition of forced air ventilation may be required.

7. PRELIMINARIES

Ensure that each control card is compatible with the proposed detector to be connected to that control card.

Ensure that where an AC to DC Power Supply Unit is to be used, this is compatible with the local mains ac supply voltage and that the PSU power rating is adequate for its individual system load.

Note: The model 05701-A-0405 and 05701-A-0406 AC to DC Power Supply Units operate, without the requirement of input voltage adjustments, from an 85V to 264V, 47Hz to 440Hz ac supply inputs.

8. CABINET INSTALLATION

Two cabinets are available, an 8-way to accommodate the 8-way **front access** rack and a 16-way to accommodate the 16-way **front access** rack.

The cabinet must be secured to a wall, or other suitable vertical surface, as follows:

CHAPTER 4 INSTALLATION INSTRUCTIONS

- (1) Knock out the bottom gland-plate entries as appropriate for the system cabling and fit the glands before mounting the cabinet.
- (2) Attach the four mounting brackets provided to the cabinet.
- (3) Using the dimensions shown mark the position of the mounting holes on the mounting surface.
- (4) Drill and wall plug the mounting holes as necessary.

Note: The mounting brackets will accept up to a 10mm (0.4") diameter screw.

- (5) Secure the cabinet in position using appropriate mounting screws.
- (6) Fit the System 57 Rack and AC to DC Power Supply Unit (if required) into the cabinet in the positions as shown.
- (7) Pass cables through the gland adjacent to field terminal blocks, where possible keeping the detector and sensor cable(s) separate from the other wiring.
- (8) Prepare and connect the cable ends to the Interface Card terminals. For terminal identification see Chapter 2.
- (9) Ensure that the cabinet is properly earthed by connecting a suitable earth cable to the earth stud located in the bottom panel of the cabinet.
- (10) Close and lock the cabinet.



CAUTION

Do not apply power to the System 57 until the commissioning procedure has been read and understood. See Chapter 5.

CHAPTER 4 INSTALLATION INSTRUCTIONS

Cabinet Dimensions:

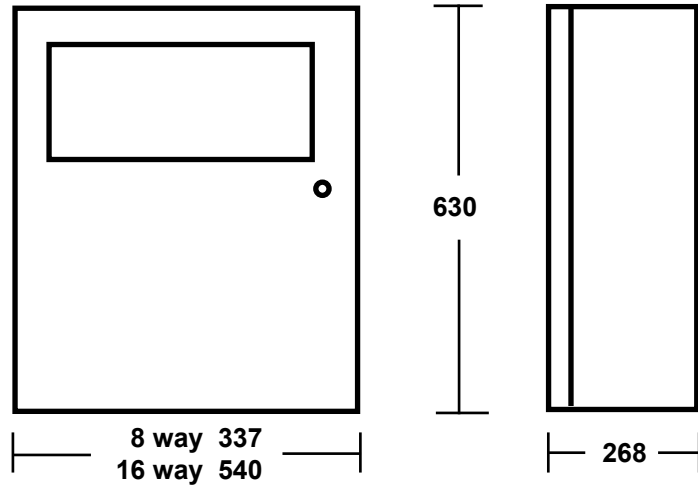

All dimension shown in mm.

Wall Mounting Bracket Hole Locations

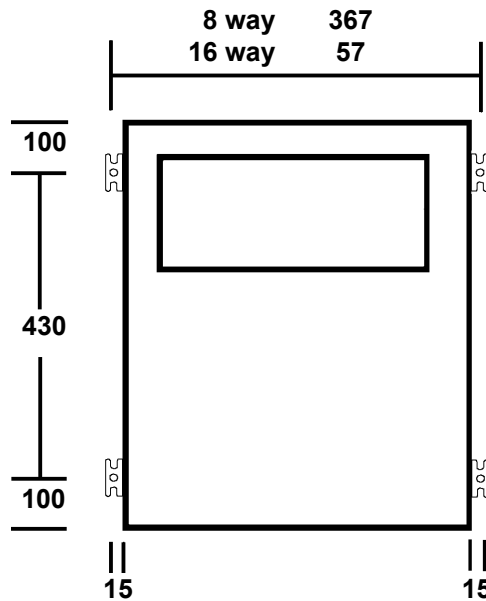

All dimension shown in mm.

Cabinet Mounting Brackets

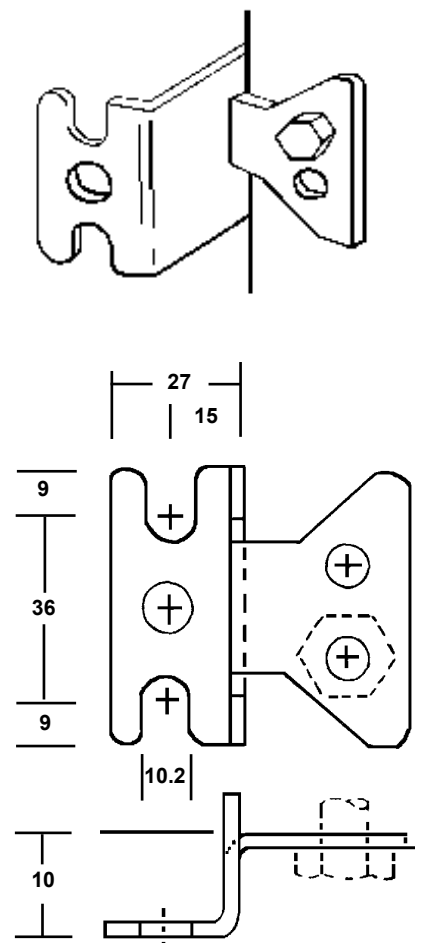

CHAPTER 4 INSTALLATION INSTRUCTIONS

Eight Card Cabinet Installation

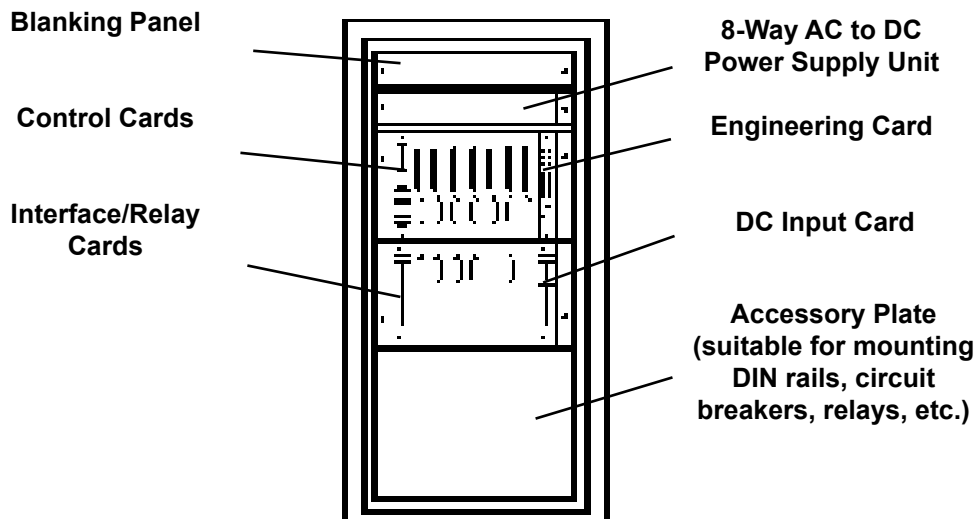

16 Card Cabinet Installation

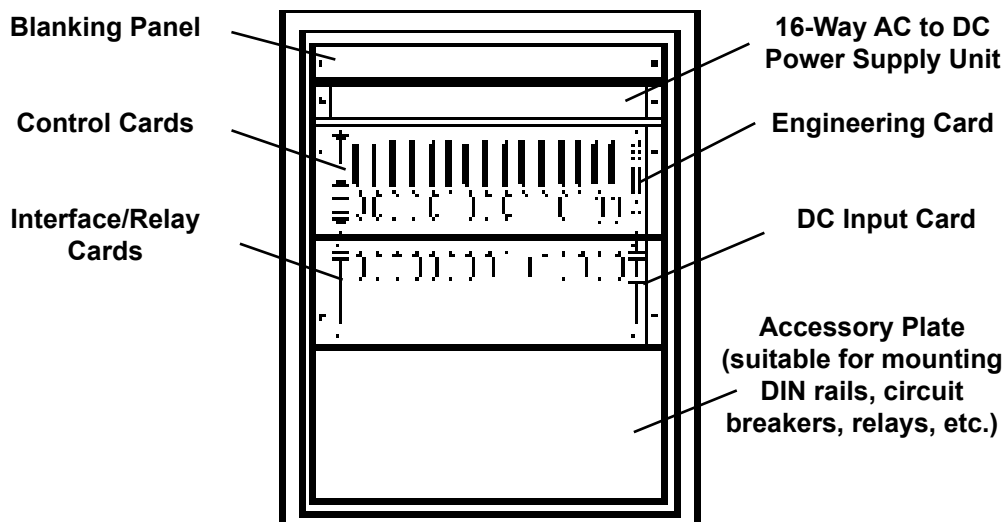

9. PANEL INSTALLATION

All racks and the AC to DC Power Supply Units are suitable for panel installation and are installed as follows:

- (1) Cut out a suitable aperture to accommodate the System 57 rack and power supply unit (where required) using the dimensions shown:

CHAPTER 4 INSTALLATION INSTRUCTIONS

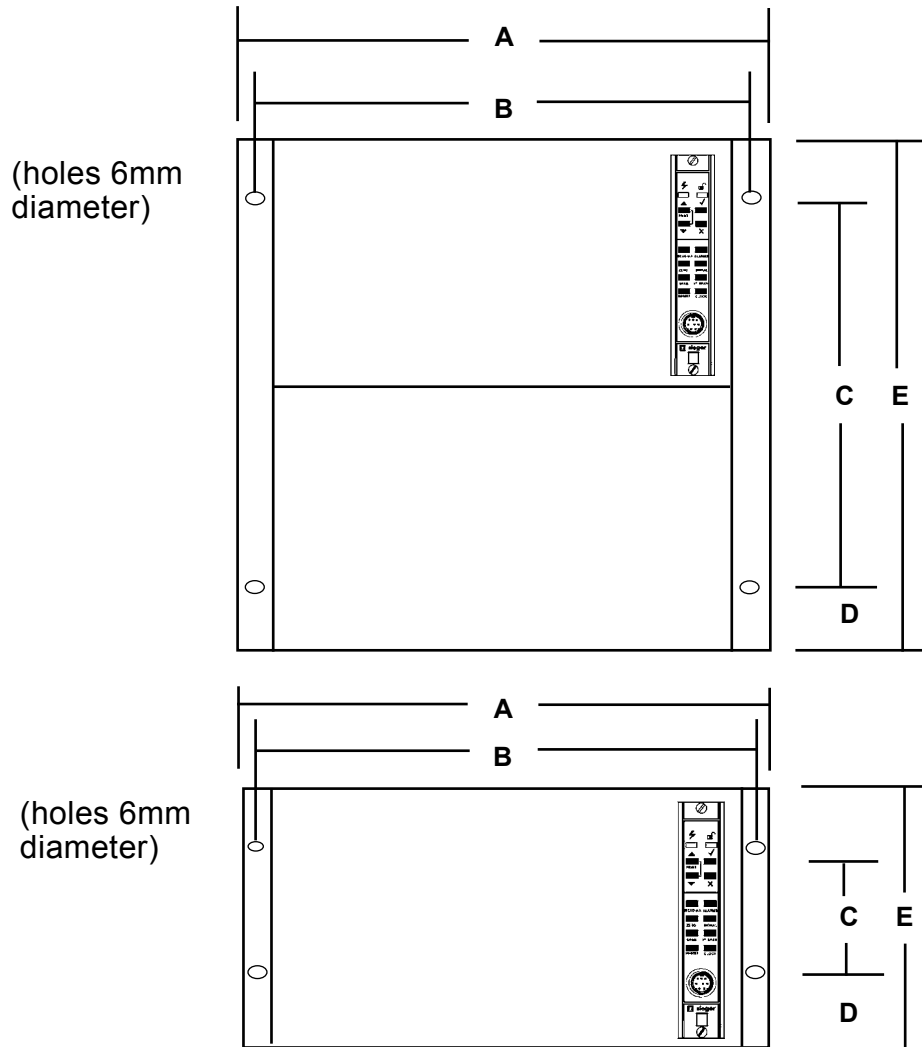

Rack Table of Sizes (mm)

Rack Assembly	A	B	C	D	E	Depth
8 Way Rear Access	279.4	261.9	57.0	37.8	132.5	287.6
8 Way Front Access	279.4	261.9	190.5	37.8	266.0	217.6
16 Way Rear Access	482.6	465.1	57.0	37.8	132.5	287.6
16 Way Front Access	482.6	465.1	190.5	37.8	266.0	217.6
Panel Cutout Clearance						
8 Way 16 Way	Width: 247 450		Height as column E as column E			

CHAPTER 4 INSTALLATION INSTRUCTIONS

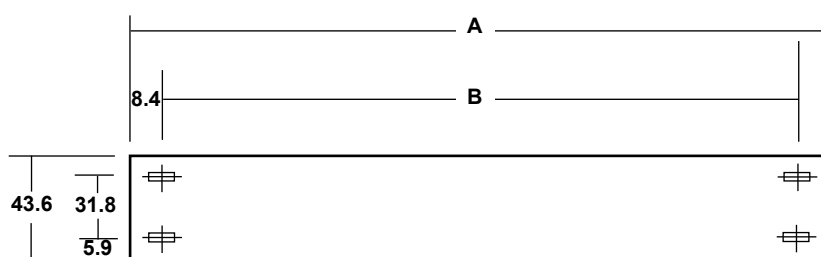

AC to DC PSU Table of Sizes (mm)

PSU Assembly	A	B	Clearance		
			Width	Height	Depth
8 Way	279.4	261.9	222	41	190
16 Way	482.6	465.1	443	41	190

- (2) Insert the rack into the aperture and secure using M6, or similar bolts, through the four mounting holes located upon the front flange plates.
- (3) Ensure adequate support at the rear of rear access racks.
- (4) Prepare and connect the cable ends to the Interface Card terminals. For terminal identification see Chapter 2. Where possible keep the detector and sensor cables separate from the other wiring.
- (5) Ensure that the rack is properly earthed by connecting a suitable earth cable to the earth stud located at the rear of the rack.



CAUTION

Do not apply power to the System 57 until the commissioning procedure has been read and understood. See Chapter 5.

10. RACK INSTALLATION

The 16-way 3U high rear access and 6U high front access racks are suitable for mounting in standard 19" (483mm) wide Mounting Frames. These are fitted as follows:

- (1) Insert the rack into the 19" Mounting Frame and secure using M6 or similar bolts through the four mounting holes located on the front flange plates.

CHAPTER 4 INSTALLATION INSTRUCTIONS

- (2) Ensure adequate support at the rear of rear access racks.
- (3) Prepare and connect the cable ends to the Interface Card terminals. For terminal identification see Chapter 2. Where possible keep the detector and sensor cables separate from the other wiring.
- (4) Ensure that the rack is properly earthed by connecting a suitable earth cable to the earth stud located at the rear of the rack.



CAUTION

Do not apply power to the System 57 until the commissioning procedure has been read and understood. See Chapter 5.

11. DETECTOR INSTALLATION

11.1 General

Always install the detectors in accordance with the manufacturers instructions.

In general, detectors for smoke and heat should be located at a high level.

Do **NOT** install the detectors:

- a. Where the normal air flow may be impeded.
- b. In corners of rooms where static air pockets may exist.
- c. Near sources of heat such as convector heaters.

DO install the detectors:

- a. In accordance with the detector manufacturers instructions.
- b. As close as possible to potential sources of fire in order to give the earliest possible warning.
- c. So that the number of zones and zone size is appropriate for the installation to be protected.
- d. So that they are accessible for maintenance work.

CHAPTER 4 INSTALLATION INSTRUCTIONS

Install the Sounders and Visual Alarm indicators:

- a. In sufficient numbers appropriate to the size and layout of the installation to be protected.
- b. Of a suitable type such that they will be seen or heard easily above the prevailing ambient conditions.

Install the Manually Activated Call Points (MAC):

- a. In all inhabited areas.
- b. On all exit routes.

The following points are considered good practice:

- a. Manually Activated Call Points should be on a separate loop input to other types of detector.
- b. Use only one detector per loop input when using flame detectors.

11.2 Compatible Detector Types

The System 57 Fire Card input is compatible with most types of detector from many different manufacturers including:

Smoke	Ionisation or Optical.
Heat	Fixed Temperature or Rate of Rise.
MAC	Switch.
Flame	UV, IR or UV/IR.

The basic requirements for correct operation are:

- a. Any detector with a low quiescent current of typically 20 to 120 μ A and an alarm current of 15 to 30mA (250 ohms to 1k ohms alarmed impedance) can be directly connected to any fire input.
- b. Multiple detectors can be connected in parallel on the same fire input provided the sum of the quiescent currents does not exceed 2.5mA worst case. When multiple detectors are used they should be of a type that disable at low voltage (7 to 10V) to prevent multiple trips causing the loop current to exceed the fault limit.
- c. The detector should be completely reset when the loop power is switched off for five seconds.

CHAPTER 4 INSTALLATION INSTRUCTIONS

- d. Detectors with voltage free contact outputs may be connected provided suitable alarm current limiting resistors are fitted in series with the alarm contact.

It should be noted that:

- a. Most smoke and heat detectors have alarm current limiting resistors built-in. Detectors with higher output current may however require additional limiting resistors in the loop supply line.
- b. Modern manual call points (MAC) usually have alarm current setting resistors built-in, otherwise a typical alarm resistor of 620 ohms must be fitted in series with the switch.
- c. Higher powered detectors such as many flame units require a separate supply via a 3 or 4 wire connection. Check the manufacturers instructions since separate provision for power isolation in order to reset the detector may be required.

11.3 Fire Input Circuit Topology

The 5704F fire input circuit operates from the system dc input supply (21 to 32V) but has a built-in voltage limiter that limits the maximum loop voltage to +24V to protect the detectors from damage. When the system supply is less than +24V the limiter has no effect and the loop will see the true input supply voltage.

The loop current is determined by measuring the voltage across a 220 ohm current sense resistance. A link selectable 330 ohm barrier equivalent resistance is incorporated for use when an external IS barrier is NOT fitted.

For fault monitoring purposes, an end of line (EOL) resistor must be fitted in or after the last detector on the loop. The typical value for the end of line resistance is 5.1k ohms although this may need to be reduced when many detectors are fitted onto the loop.

During the reset process, the power to the detection loop is removed for 5 seconds.

CHAPTER 4 INSTALLATION INSTRUCTIONS

An equivalent circuit of one fire input together with an example detector connection is shown below:-

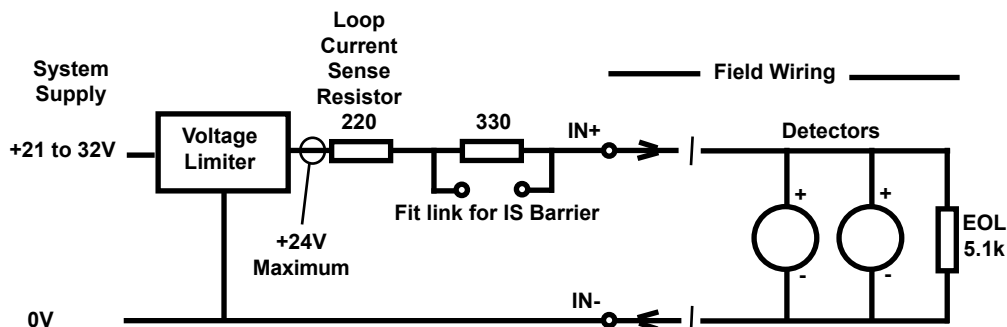

11.4 Line Resistance

Detectors should be located such that the line resistance of the cable required does not prevent correct operation. As a general guide and for a typical installation of twenty low quiescent current detectors, the loop cable resistance should be kept below 100 ohms total (50 ohms per core). The table below gives a quick guide to the maximum cable lengths permitted in this case:

Maximum Cable Length (m)					
Detectors	Conductor Cross Sectional Area				
	21	19	18	16	14
AWG					
mm ²	0.50	0.75	1.00	1.50	2.50
20 low quiescent (100µA) detectors	1300	2000	2700	4100	6500

The next section provides a more detailed approach to the determination of the maximum loop resistance and operating conditions.

11.5 Number of Detectors Versus Line Resistance

There are a number of criteria that limit the maximum cable resistance and number of detectors in a particular installation:

- a. In the quiescent state (non-alarm condition) the loop voltage must be sufficient to power the detectors (typically 17V) and the loop current must be within the normal operating band (default 3 to 10mA).

CHAPTER 4 INSTALLATION INSTRUCTIONS

- b. When a detector enters the alarm condition the loop current must be within the fire alarm band (default 10 to 30 mA).
- c. If a short circuit is placed across the end of line the loop current must exceed the short circuit fault threshold (default 30 mA).

In the quiescent condition, the total line resistance can be determined as follows:

$$R_{\text{LOOP}} = \frac{V_{\text{LOOP(min)}} - V_{\text{DET(min)}} - R_{\text{SENSE}}}{I_{\text{EOL}} + \sum I_{\text{Q}}}$$

Where: R_{LOOP} = Total line resistance in ohms.

$V_{\text{LOOP(min)}}$ = Minimum loop drive voltage in volts.

$V_{\text{DET(min)}}$ = Minimum detector operating voltage in volts.

I_{EOL} = Current through end of line resistor in amps.

$\sum I_{\text{Q}}$ = Sum of detector quiescent currents in amps.

R_{SENSE} = Fire Card current sense resistor resistance in ohms.

Using the typical example given above of a loop fitted with 20 low current 100 μ A quiescent detectors that require 17V minimum for normal operation, then:

$$V_{\text{DET(min)}} = 17\text{V and total } I_{\text{Q}} = 20 \times 100\mu\text{A} = 2\text{mA.}$$

$$\text{Using typical values: } V_{\text{LOOP(min)}} = 21\text{V,}$$

$$I_{\text{EOL}} = 4 \text{ mA (typical) and}$$

$$R_{\text{SENSE}} = 560 \text{ ohms}$$

Hence:

$$R_{\text{LOOP}} = 100 \text{ ohms total or 50 ohms per core.}$$

The sum of the detector and end of line terminator quiescent currents must be within the band of normal operation (default 3mA to 10mA).

In this case 4 + 2 = 6 mA and this is satisfactory.

In the alarm state the range of acceptable alarm resistance can be determined as follows:

CHAPTER 4 INSTALLATION INSTRUCTIONS

$$R_{ALM} = \frac{V_{LOOP(min)}}{I_{ALM}} - R_{SENSE} - R_{LOOP}$$

Where: R_{ALM} = Alarm resistance in ohms.

$V_{LOOP(min)}$ = Minimum loop drive voltage in volts.

I_{ALM} = Loop current in alarm condition in amps.

R_{SENSE} = Fire Card current sense resistor resistance in ohms.

R_{LOOP} = Total line resistance in ohms.

Based upon the default setting for the alarm current, I_{ALM} ranges from 10mA to 30mA giving a range for R_{ALM} of between 40 ohms and 1.4k ohms which will easily accommodate the common values of most detectors.

Under the short circuit condition the loop current, which must be greater than the fault threshold (default 30mA), can be determined as follows:

$$I_{S/C} = \frac{V_{LOOP(min)}}{R_{SENSE} + R_{LOOP}}$$

Where: $I_{S/C}$ = Loop short circuit current in amps.

$V_{LOOP(min)}$ = Minimum loop drive voltage in volts.

R_{SENSE} = Fire Card current sense resistor resistance in ohms.

R_{LOOP} = Total line resistance in ohms.

Using the typical values for $V_{LOOP(min)}$ and R_{SENSE} with the calculated value of R_{LOOP} :

Then $I_{S/C} = 32mA$ which is satisfactory.

11.6 Separately Powered Detectors

The maximum line resistance of cabling for a separately powered detector powered from the System 57 varies with the voltage and current requirements of the detector. It is also subject to the minimum supply voltage available from the System 57.

Maximum line loop resistance is calculated as follows:

$$R_{Loop} = \frac{V_r - V_s}{I_s}$$

4-20

CHAPTER 4 INSTALLATION INSTRUCTIONS

Where: R_{Loop} = Total Line Resistance (ohms)
 V_r = Minimum DC Supply to System 57 (V)
 V_s = Sensor Voltage (V)
 I_s = Sensor Current (A)

Making the above calculation using a V_r of 21V will accommodate the worst case low dc supply situation.

The maximum resistance **per core** can be calculated from the above configurations as follows:

$$\text{Maximum Resistance of Core} = \frac{R_{Loop}}{2} \quad \text{ohms}$$

11.7 Cable Resistance Guide

A guide to the resistance of various copper cable sizes is given below:

Solid Copper Conductor		
Cross Sectional Area		Maximum resistance at 20°C (ohm/km)
(mm ²)	AWG	
0.50	21	36.0
0.75	19	25.0
1.00	18	18.0
1.50	16	12.0
2.50	14	7.6
Stranded Copper Conductor		
Cross Sectional Area		Maximum resistance at 20°C (ohm/km)
(mm ²)	AWG	
0.50	21	36.8
0.75	19	24.5
1.00	18	17.6
1.50	16	11.7
2.50	14	7.4

CHAPTER 4 INSTALLATION INSTRUCTIONS

12. DETECTOR CONNECTIONS

12.1 General



WARNING

Incorrect connection of the detector wires may cause damage to both the detector and System 57.

CAUTION

The detectors connections must always be made with the System 57 unit in an unpowered state. Isolate power supplies at their source before making connections.

Ensure that any external dc backup battery supply is also disabled.

IMPORTANT

In order to ensure the correct operation of the system and to meet European Standards for RFI and EMC, all detector field cables must be screened. The cable screen of each detector should be connected to the cabinet protective earth.

Connect the cabling to detectors in accordance with the Detector Manufacturers Instructions and run the field cables back to the System 57 unit. The detector cables should be routed away from sources of interference such as ac power cables, motors, machinery etc.

Use the information on the configuration sheet provided with the unit to decide which detector to connect to each channel. The following sections describe the various connections topologies for the Fire Control Card.

12.2 Typical Loop Powered Detector Connections

Loop powered detectors (eg. most smoke, heat and manual call points) have two wire connection. The detector documentation will indicate the positive and negative loop connections. Multiple detectors may be connected in parallel on a single loop input provided the loop operational limit for quiescent current is not exceeded.

At the System 57 end of the field cables, the two detector wires should be connected to the appropriate channels IN+ and IN- terminals of the Hex Relay Interface Card that is attached to the required 5704F Control Card. The loop current always flows from the IN+ terminal and returns via the IN- terminal.

CHAPTER 4 INSTALLATION INSTRUCTIONS

For fault monitoring purposes an end of line (EOL) resistor must be fitted in or after the last detector on the loop. The typical value for end of line resistance is 5.1k ohms.

The detector cable screen, or steel wire armour or braid as appropriate, should be connected to the system protective earth. This can be achieved where the cable enters the cabinet by using a metal cable gland, or by other suitable means, and avoiding any screen tails within the cabinet.

Where the cable consists of a separate screen sheath and wire armour or braid, the armour should be connected at the cabinet entry to the protective earth and the screen sheath should be connected to the GROUND terminal of the Hex Relay Interface Card or to a suitable instrument earth point.

CHAPTER 4 INSTALLATION INSTRUCTIONS

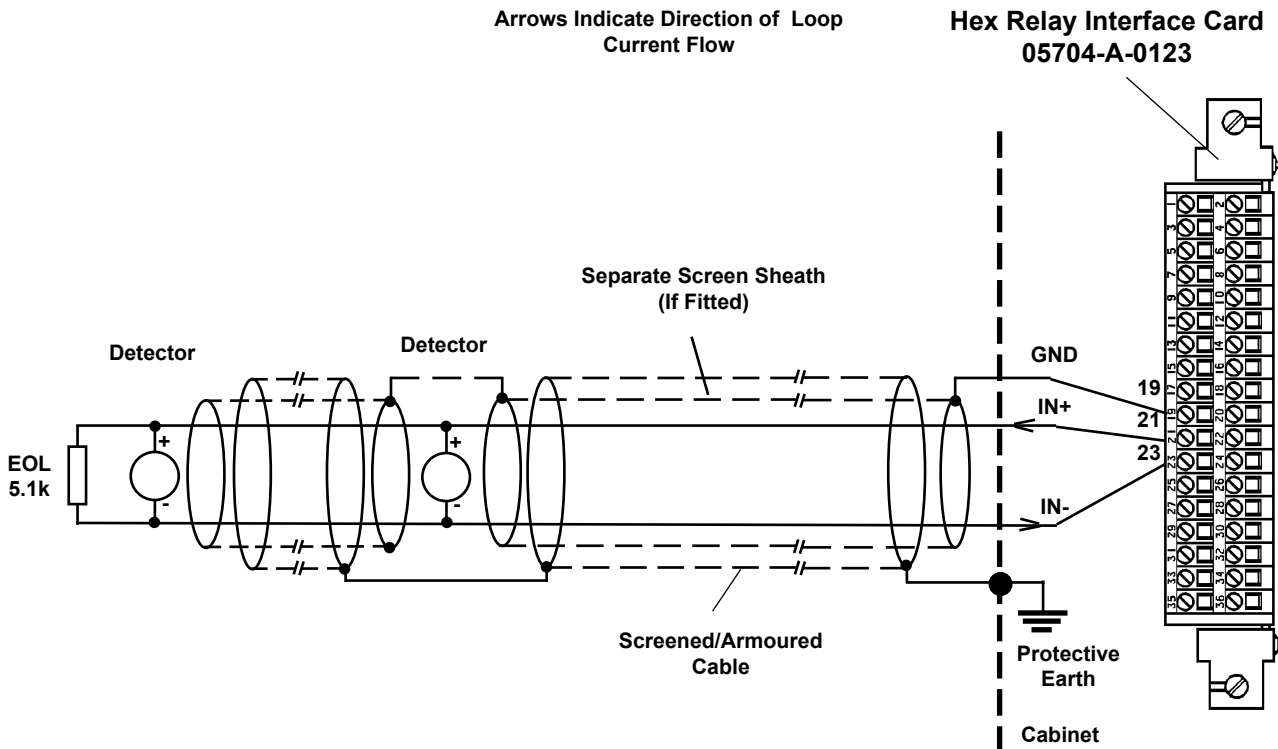

- Notes: 1. Where a detector is earthed locally, either to an Earth Stud or through the detector casing or mounting, to avoid earth loops the screen sheath of the cable should only be connected at one end.
2. The above diagram shows the detector connections for Channel 1. Channels 2, 3 and 4 connections are similar and their pin connection numbers are shown below:

	Channel	Detector Connection		
		IN+	IN-	Ground
Hex Relay Interface Connections	1	21	23	19
	2	22	24	20
	3	27	29	19
	4	28	30	20

Typical Loop Powered Detector and Terminal Block Connections

CHAPTER 4 INSTALLATION INSTRUCTIONS

12.3 Typical Loop Powered Detector with IS Barrier Connections

Loop powered intrinsically safe detectors (eg. most smoke, heat and manual call points) have two wire connection. The detector documentation will indicate the positive and negative loop connections. Multiple detectors may be connected in parallel on a single loop input provided the IS criteria and loop operational limit for quiescent current are not exceeded.

In the safe area, the two wires from the detector should be connected to the field (hazardous area) side of the barrier. The input (safe area) side wires from the barrier should be connected to the appropriate channels IN+ and IN- terminals of the Hex Relay Interface Card that is attached to the required 5704F Control Card. The loop current always flows from the IN+ terminal and returns via the IN- terminal. The barrier must be earthed appropriately.

For fault monitoring purposes an end of line (EOL) resistor must be fitted in or after the last detector on the loop. The typical value for end of line resistance is 5.1k ohms.

When using an external barrier the IS compatibility link for the input must be set appropriately, see section Chapter 2 Section 4.3.

Intrinsically safe systems must be earthed at one point only. All detector cable screens should be connected separately to the IS safety ground.

CHAPTER 4 INSTALLATION INSTRUCTIONS

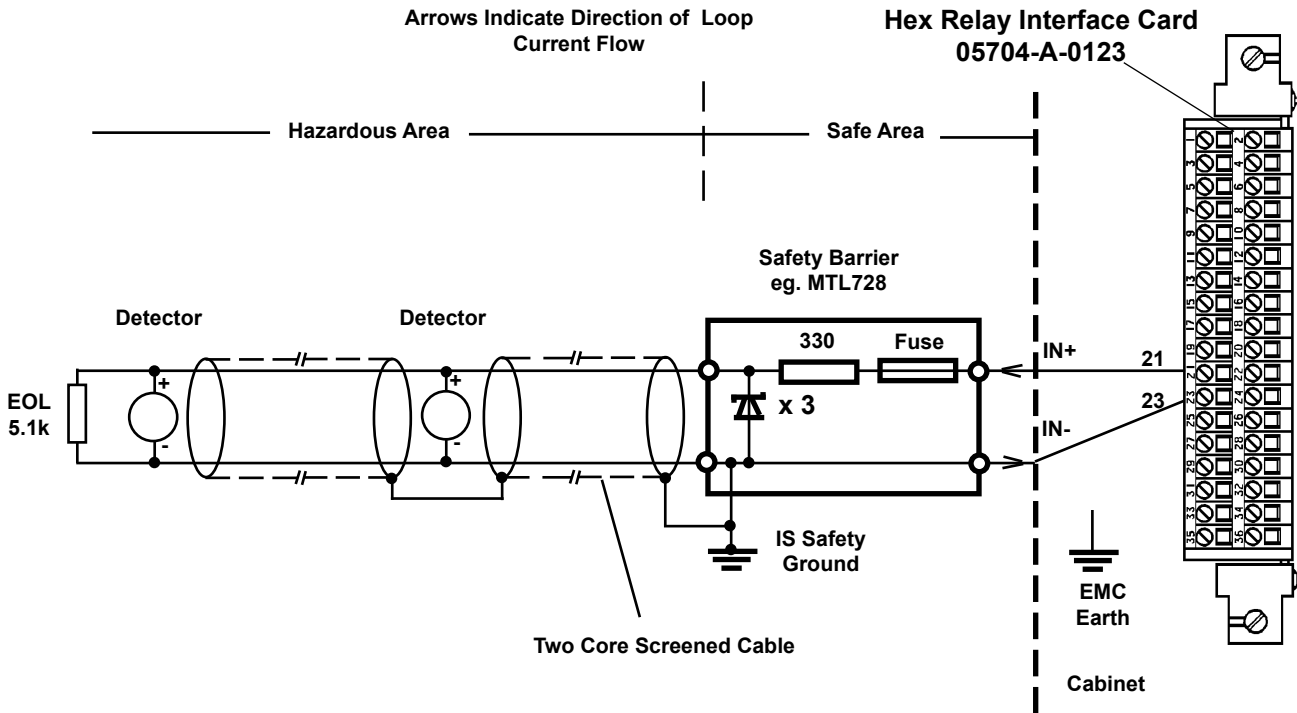

- Notes:
1. Earth Leakage must not be used with single or dual barriers since the 0V is connected to IS ground. If earth leakage is required an isolating barrier must be used.
 2. A suitable barrier specification is a 28V 300 ohm Shunt Barrier with 50mA minimum current capability for short circuit survival.
 3. The above diagram shows the detector connections for Channel 1. Channels 2, 3 and 4 connections are similar and their terminal block connection numbers are shown below:

	Channel	Detector Connection		
		IN+	IN-	Ground
Hex Relay Interface Connections	1	21	23	19
	2	22	24	20
	3	27	29	19
	4	28	30	20

Typical Loop Powered Detector, IS Barrier and Terminal Block Connections

CHAPTER 4 INSTALLATION INSTRUCTIONS

12.4 Separately Powered Detectors

Separately powered detectors (eg. most IR, UV/IR Flame detectors) require three or four wire connections. The detector documentation will indicate the 0V and +24V power connections and the positive and negative loop connections. When using flame detectors it is common practice to use only one detector per loop input.

At the System 57 end of the field cables the two detector signal wires should be connected to the appropriate channels IN+ and IN- terminals of the Hex Relay Interface Card that is attached to the required 5704F Control Card. The loop current always flows from the IN+ terminal and returns via the IN- terminal.

The power for the detector may be sourced from the System 57 power supply or a separate field supply, whichever is most appropriate. In small systems, power can be obtained from terminals 35 and 36 of the Hex Relay Interface Card, but care must be taken not to exceed the maximum backplane current loading of 8A. A separate dc power distribution block is recommended.

For fault monitoring purposes, an end of line (EOL) resistor must be fitted in or after the last detector on the loop. The typical value for end of line resistance is 5.1k ohms.

The detector cable screen, or steel wire armour or braid as appropriate, should be connected to the system protective earth. This can be achieved where the cable enters the cabinet by using a metal cable gland, or by other suitable means, and avoiding any screen tails within the cabinet.

Where the cable consists of a separate screen sheath and wire armour or braid, the armour should be connected at the cabinet entry to the protective earth and the screen sheath should be connected to the GROUND terminal of the Hex Relay Interface Card or to a suitable instrument earth point.

Notes: 1. Separate provision may be required for power supply isolation

CHAPTER 4 INSTALLATION INSTRUCTIONS

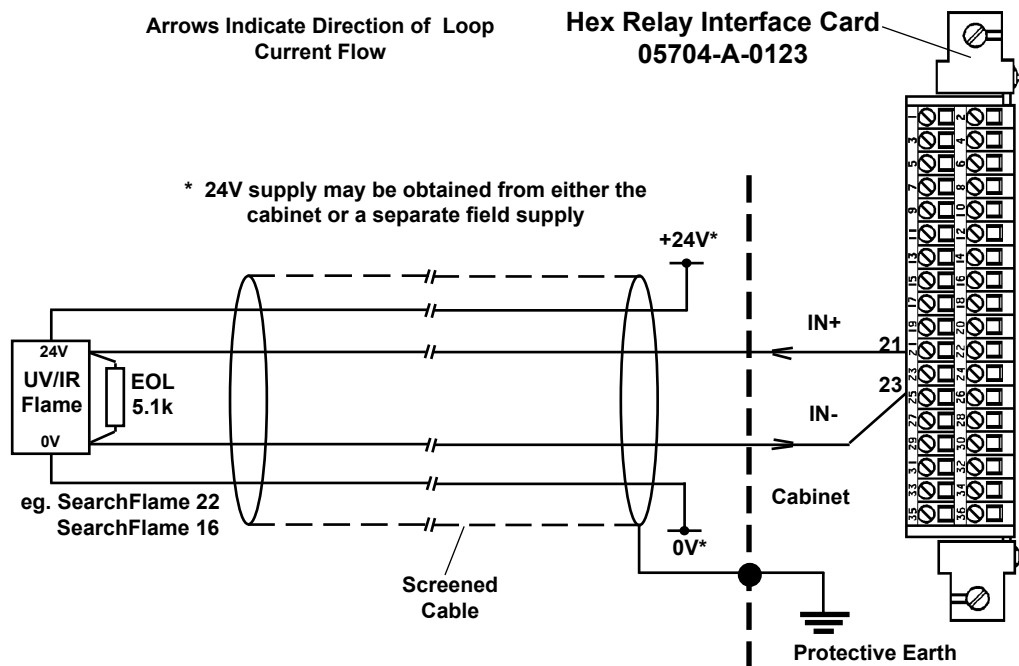

in order to reset the detector after an alarm condition. Consult the detector operating instructions for more details.

2. *For a 3 wire connection, the IN- signal can return via the 0V supply but care should be taken with the system layout to minimise electrical noise and other forms of interference.*
3. *Where a detector is earthed locally, either to an Earth Stud or through the sensor casing or mounting, to avoid earth loops the screen sheath of the cable should be connected at one end only.*
4. *The above diagram shows the detector connections for Channel 1. Channels 2, 3 and 4 connections are similar and their terminal block connection numbers are shown below:*

	Channel	Detector Connection		
		IN+	IN-	Ground
Hex Relay Interface Connections	1	21	23	19
	2	22	24	20
	3	27	29	19
	4	28	30	20

Typical Separately Powered Detector and Terminal Block Connections

CHAPTER 4 INSTALLATION INSTRUCTIONS

12.5 Call Points and Simple Switched Output Detectors

Manually Activated Call Points (MAC) and some fire detectors have a simple switched alarm output via two wire connection. The detector documentation will indicate the switch contact connections. Many call points may be connected in parallel on a single loop input, but it is good practice to keep call points on a separate input to other types of detector.

At the System 57 end of the field cables the two call point signal wires should be connected to the appropriate channels IN+ and IN- terminals of the Hex Relay Interface Card that is attached to the required 5704F Control Card. The loop current always flows from the IN+ terminal and returns via the IN- terminal.

For fault monitoring purposes an end of line (EOL) resistor must be fitted in or after the last call point on the loop. The typical value for end of line resistance is 5.1k ohms.

The detector cable screen, steel wire armour or braid as appropriate, should be connected to the system protective earth. This can be achieved where the cable enters the cabinet by using a metal cable gland, or by other suitable means, and avoiding any screen tails within the cabinet.

Where the cable consists of a separate screen sheath and wire armour or braid, the armour should be connected at the cabinet entry to the protective earth and the screen sheath should be connected to the GROUND terminal of the Hex Relay Interface Card or to a suitable instrument earth point.

CHAPTER 4 INSTALLATION INSTRUCTIONS

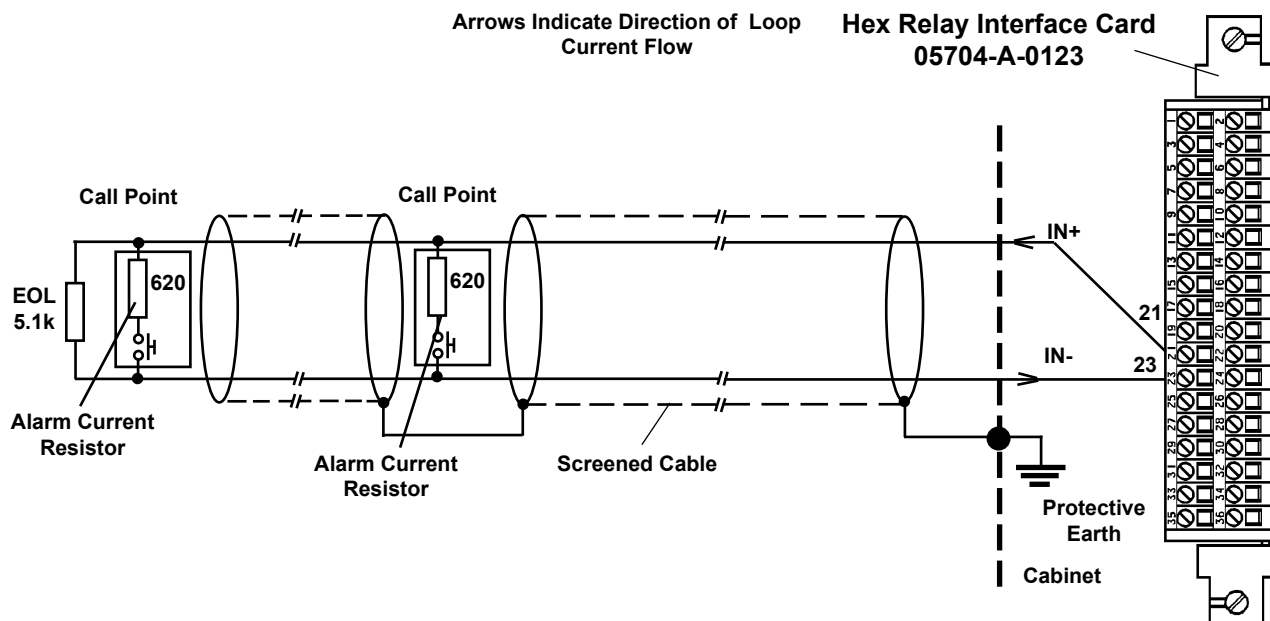

- Notes:*
1. Most modern call points already incorporate the alarm current resistor, shown with a typical value of 620 ohms, if not this can be easily fitted externally within the call point junction box.
 2. The Fire Card inputs are also compatible with devices that use a zener diode, typical value 8.2V, 0.5W, to set the alarm current.
 3. The operation of more than two call points simultaneously may cause the loop current to exceed the short circuit warning threshold. This will not suppress the alarm output but a fault indication will be given on the fire card display.
 4. Where the call point is earthed locally, either to an Earth Stud or through the sensor casing or mounting, the screen sheath of the cable should be connected at one end only to avoid earth loops.
 5. The above diagram shows the detector connections for Channel 1. Channels 2, 3 and 4 connections are similar and their terminal block connection numbers are shown below:

	Channel	Detector Connection		
		IN+	IN-	Ground
Hex Relay Interface Connections	1	21	23	19
	2	22	24	20
	3	27	29	19
	4	28	30	20

Typical Call Point and Terminal Block Connections

CHAPTER 4 INSTALLATION INSTRUCTIONS

12.6 Detectors with Voltage Free Contact Outputs

Some fire detectors (especially flame) are equipped with a voltage free contact for the alarm output and often with a second voltage free contact for fault output. These types of detector are easily connected to the fire card using a two wire connection. The detector documentation will indicate the voltage free contact connections. Although a number of detectors may be connected in parallel on a single loop input, it is good practice to connect only one flame detector on any input.

At the System 57 end of the field cables the signal wires should be connected to the appropriate channels IN+ and IN- terminals of the Hex Relay Interface Card that is attached to the required 5704F Control Card. The loop current always flows from the IN+ terminal and returns via the IN- terminal.

For fault monitoring purposes, an end of line (EOL) resistor must be fitted in or after the last detector on the loop. The typical value for end of line resistance is 5.1k ohms.

The detector cable screen or steel wire armour or braid as appropriate, should be connected to the system protective earth. This can be achieved where the cable enters the cabinet by using a metal cable gland, or by other suitable means, and avoiding any screen tails within the cabinet.

Where the cable consists of a separate screen sheath and wire armour or braid, the armour should be connected at the cabinet entry to the protective earth and the screen sheath should be connected to the GROUND terminal of the Hex Relay Interface Card or to a suitable instrument earth point.

CHAPTER 4 INSTALLATION INSTRUCTIONS

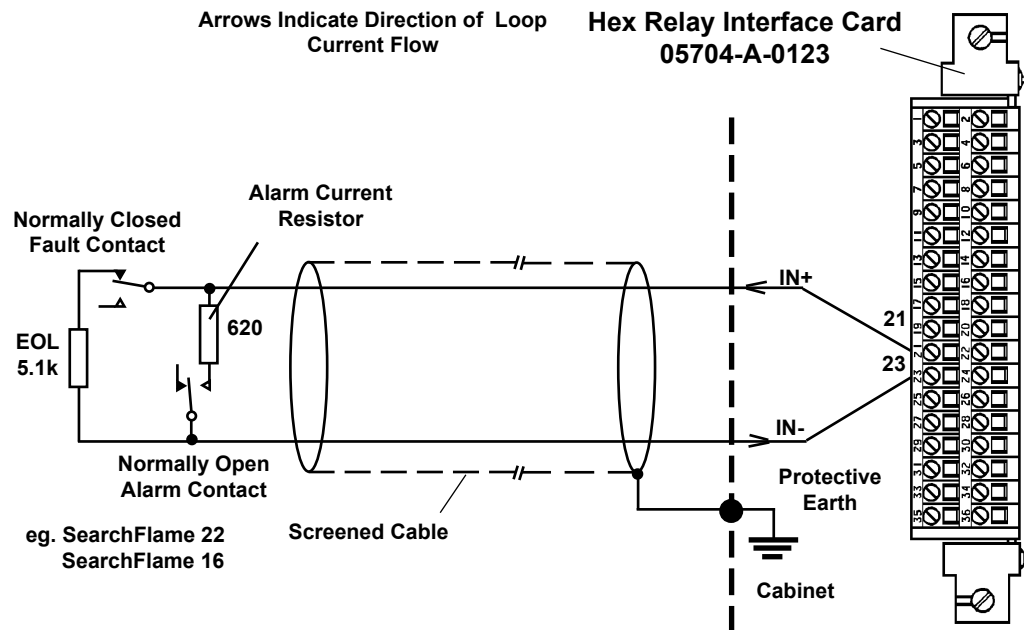

- Notes:*
1. Some detectors may incorporate the alarm current resistor shown with a typical value of 620 ohms, if not, this can be easily fitted externally within the detector junction box.
 2. Where the detector is earthed locally, either to an earth stud or through the detector casing or mounting, to avoid earth loops the screen sheath of the cable should be connected at one end only.
 3. The above diagram shows the detector connections for Channel 1. Channels 2, 3 and 4 connections are similar and their terminal block connection numbers are shown below:

	Channel	Detector Connection		
		IN+	IN-	Ground
Hex Relay Interface Connections	1	21	23	19
	2	22	24	20
	3	27	29	19
	4	28	30	20

Typical Volt Free Output Detector and Terminal Block Connections

CHAPTER 4 INSTALLATION INSTRUCTIONS

13. OUTPUTS

13.1 Output Types

The System 57 Fire Control System is equipped with two different output capabilities. Each 5704F Control card offers two fault monitored switched dc outputs and between six and 16 voltage free relay outputs depending upon the type of relay card fitted. The switched dc outputs are powered from the system dc power supply (21 to 32V) and fused at 1A maximum. For relay ratings see Chapter 7 Section 5.

Outputs facilities are therefore available to suit most types of audible sounder, visual indicators and actuators from many different manufacturers.

13.2 Switched Outputs

Each output circuit, when switched on, provides power direct from the system dc power supply (21 to 32V). The outputs are fused at 1A maximum, For fuse type see Chapter 7 Section 5.3. The outputs are suitable for switching lamps, sounders, relays etc.

CAUTION

The maximum backplane current capacity of 8A must not be exceeded. Provision is made for the individual powering of each fire controller card when required.

Inductive apparatus should always be fitted with a suppression diode.

While switched off each output is monitored for short circuit and open circuit faults to ensure that the output is capable of operating when required. When switched on the output is monitored for fuse failure.

IMPORTANT

The output is reversed biased during the inactive state to facilitate monitoring for fault conditions. Equipment connected to the output must therefore have built-in polarity protection or be provided with a separate series diode.

Each output must be electrically terminated by connecting an appropriate resistance at the end of the line. The nominal end of line resistance is 22k ohms.

The output cable screen or steel wire armour or braid as appropriate, should be connected to the system protective earth. This can be achieved where the cable enters the cabinet by using a metal cable gland, or by other suitable means, and avoiding any screen tails within the cabinet.

Where the cable consists of a separate screen sheath and wire armour (or braid), the armour should be connected at the cabinet entry to the protective earth and the screen sheath should be connected to the GROUND terminal of the Hex Relay Interface Card or to a suitable instrument earth point.

CHAPTER 4 INSTALLATION INSTRUCTIONS

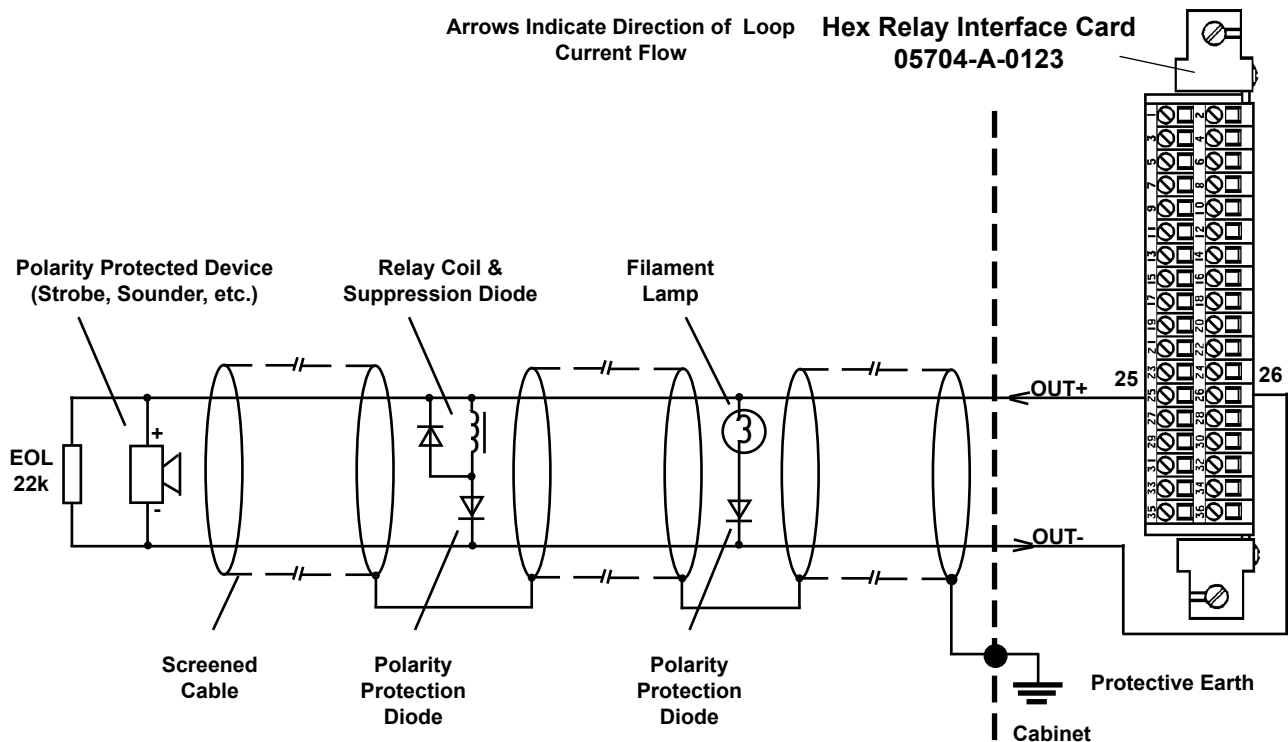

- Notes:*
1. Some devices have built in polarity protection, if not this can be easily achieved using a series diode fitted within the junction box.
 2. Where the detector is earthed locally, either to an earth stud or through the detector casing or mounting, to avoid earth loops the screen sheath of the cable should be connected at one end only.
 3. Although the outputs are not isolated from the system power supply, an external connection between OUT- and 0V is not permitted.
 4. The above diagram shows the connections for Output A. Output B connections are similar and their terminal block numbers are shown below

	Output	Device Connections		
		OUT+	OUT-	Ground
Hex Relay Card Interface Connections	A	25	26	19
	B	31	32	20

Typical Output Circuit Wiring and Terminal Block Connections

CHAPTER 4 INSTALLATION INSTRUCTIONS

13.3 Switched Outputs with Boost Circuit

Where the 1A maximum current limit of the switched outputs is not sufficient for system requirements an external boost relay circuit can be used. The following boost topology retains the fault monitoring capability for short circuit and open circuit faults of the output.

IMPORTANT

The output is reversed biased during the inactive state to facilitate monitoring for fault conditions. Equipment connected to the output must therefore have built-in polarity protection or be provided with a separate series diode.

All other guidelines stated in Section 13.2 apply including the need for an electrical termination by connecting the appropriate resistance at the end of the line.

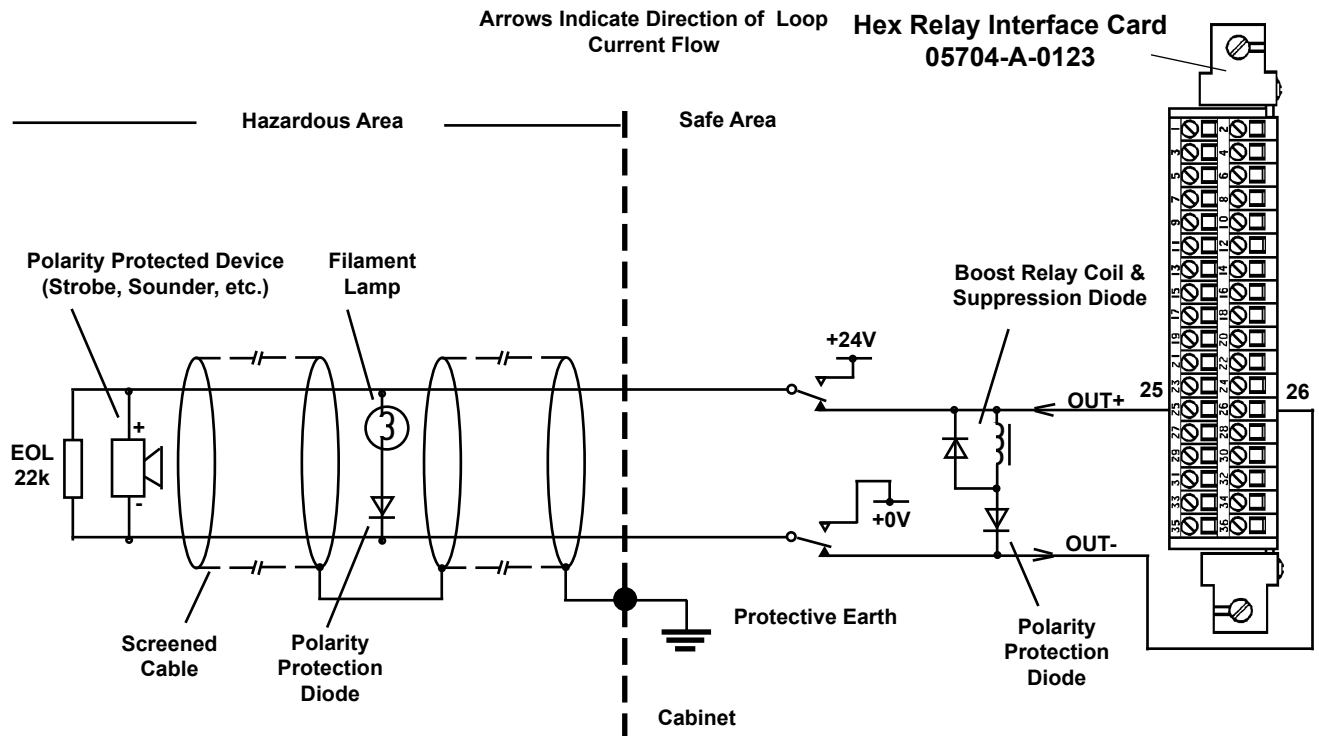

Note: The boost relay specification requires a coil voltage of 24V nominal, contact rating as per anticipated maximum field device current and voltage requirements. Fault monitoring current is only 150µA.

CHAPTER 4 INSTALLATION INSTRUCTIONS

13.4 Relay Outputs

*Note: The **FAULT** relay is permanently configured for normally **ENERGISED** operation in the non-fault condition.*



CAUTION

When mains ac is connected to the relay contacts:

- a. The ac supply should be fused at 5A maximum.
- b. A safety earth connection should be made to the ground terminal of the relay card.

There are two options for voltage free relay outputs. The standard Hex Relay Card provides six relay outputs, while the 5704F Relay Interface Assembly provides sixteen relay outputs. For relay ratings see Chapter 7 Section 5. Before installation it is important to check the function and operating state of each relay by referring to the configuration printout supplied with all new systems.

For terminal block and relay contact numbering refer to Chapter 2 Section 5.

The cabling to the relays should where possible be kept away from the detector cabling, especially those cables carrying mains supplies. The following figure shows the relay contact connections as shown on the terminal block.

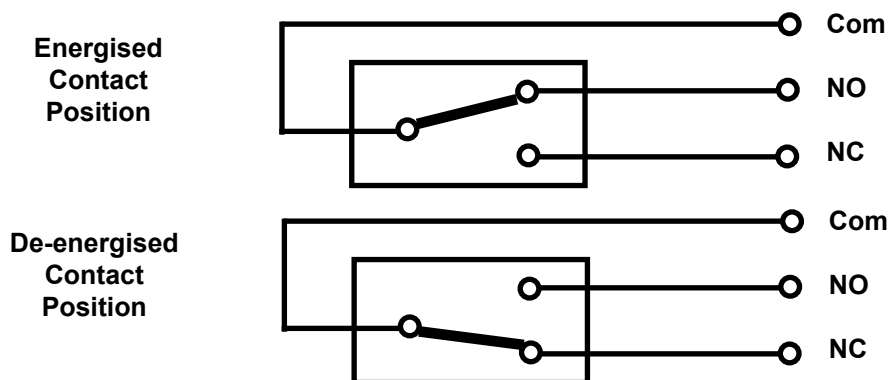

De-energised and Energised Relays Showing Contact Positions

The alarm relays may be configured for either normally de-energised or normally energised operation. Check the configuration sheet supplied with the system to determine the operating mode of the relays on each card. The energising mode of the relays can be reconfigured easily using a computer attached to the Engineering Port. Contact Zellweger Analytics or your local agent for more information.

CHAPTER 4 INSTALLATION INSTRUCTIONS

14. REMOTE INPUT CONNECTIONS



CAUTION

Connecting any external voltage to the remote inputs may cause permanent damage to the Fire Control Card.

The Fire Control Card has a single remote input connection that supports three functions.

The required function is selected by applying a specific value of resistance to the line by means of a momentary action switch as follows:

- a. Remote Accept 10k ohms.
- b. Remote Reset 4.7k ohms.
- c. Remote Silence 2.2k ohms.

The remote input functions are not subject to access level restrictions in the same way as the Fire Status Panel push-buttons. Where this is required, external means should be used such as key switches. It is not permitted to operate more than one remote input at a time.

The remote inputs of the control card, that is driving the Fire Status Panel, provide master remote functions for all of the Fire Cards fitted to the rack. In most applications this is the only remote input that will need to be connected.

Hex Relay Interface Card 05704-A-0123

The remote input is fault monitored for open and short circuits and therefore must be electrically terminated by connecting an appropriate resistance at the end of the line. The nominal end of line resistance is 22k ohms.

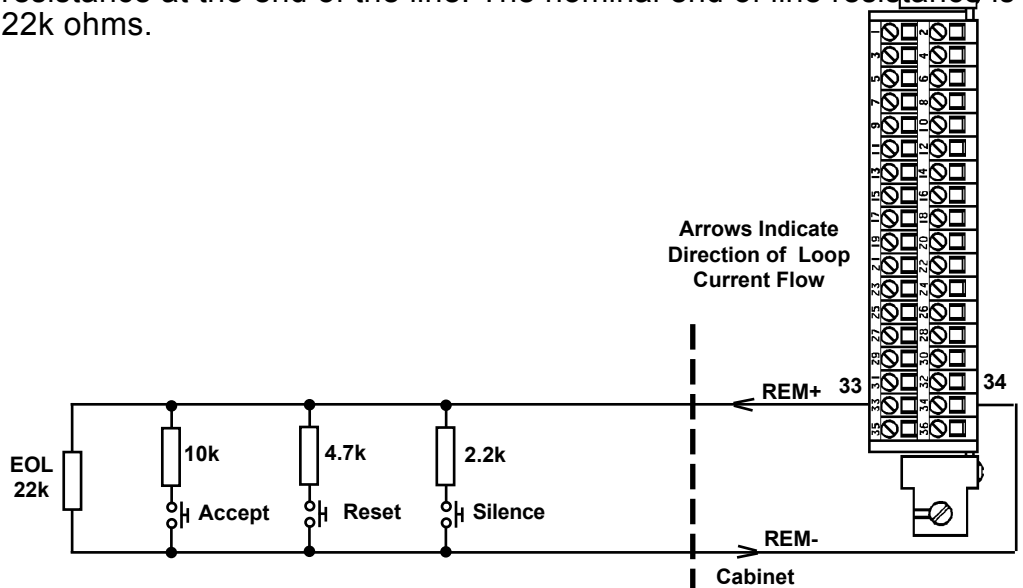

CHAPTER 4 INSTALLATION INSTRUCTIONS

15. DC POWER CONNECTIONS

15.1 General



CAUTION

The ratings of power supplies should be checked by calculating a system power budget as outlined in Section 5.

IMPORTANT

The System 57 must be earthed

DC power is connected to the System 57 via the DC Input Card terminal block TB1 and via the Quad Relay Interface Cards.

The DC Input Card provides diode isolation to permit the connection of two separate power supplies. eg. A mains derived dc power supply and battery backup dc supply. Note that current will be drawn from the supply input with the highest voltage and in some circumstances current will be shared between the two inputs. Each of the two inputs have twin +24V and 0V terminals for easy through power connection or paralleling of input sources.

A fused +24V output, which is the combination of both dc inputs, is provided for powering ancillary devices.

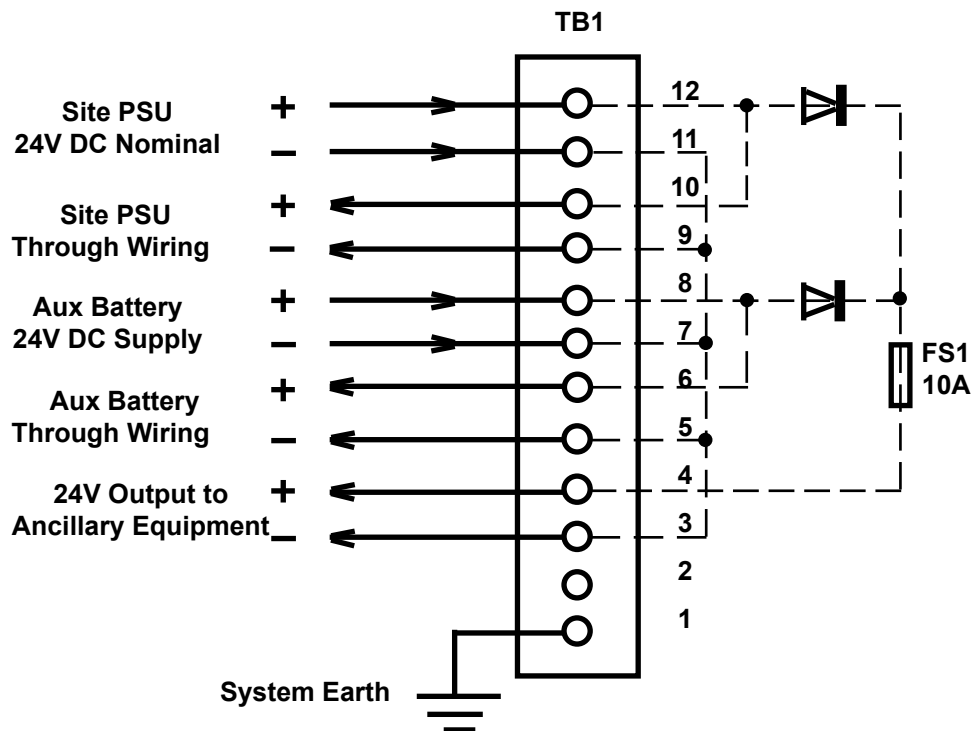

Site DC Supply and Auxiliary Battery Backup DC Power Supply Connections, With Through Wiring

CHAPTER 4 INSTALLATION INSTRUCTIONS

15.2 Individually Powered Control Cards

Note: In individually powered control systems a DC connection is still required to the DC Input Card in order to provide power to the Engineering Card.

Individually powered control cards may be required for two reasons:

- a. Where the local or other regulations dictate individual connections in order to achieve the highest integrity for power distribution.
- b. In densely populated racks to reduce the current load on the backplane.

The System 57 DC Input Card supply is fused at 10A and to ensure reliable operation of the system, the maximum continuous current flow in the rack backplane should be less than 8A. In 16 channel racks, substantially populated with four channel catalytic control cards or a number of fire cards with heavy current loads on the switched outputs, this backplane current can be exceeded, .

Individual powering of a four channel control card is easily achieved as follows:

- (1) On the Four Channel Control Card, remove the link LK1 from position 1 - 2 and refit in position 2 - 3 as shown:

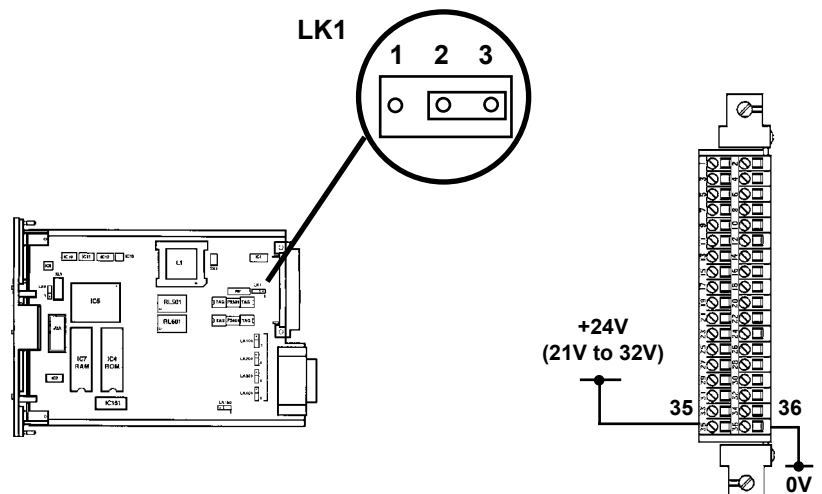

Four Channel Control Card Fire

- (2) Wire the +24V DC power supply to the respective Hex Relay Interface Card terminals 35 (+24V) and 36 (0V) as shown.

CHAPTER 4 INSTALLATION INSTRUCTIONS

16. AC TO DC POWER SUPPLY UNIT CONNECTIONS



WARNING

The AC to DC Power Supply Unit must be earthed.

The input supply to the AC to DC Power Supply Unit may be:

- a. an ac supply of 85V to 264V at 47Hz to 440Hz.
- b. a dc supply of 110V to 340V (Refer to Zellweger Analytics for information on dc supplies).

The supply must be fused at 6A maximum at the supply source. eg. At the distribution panel. Where additional cabling is used this must be mains rated for a minimum of 6A.

Two cables emerge from the rear of the AC to DC Power Supply Unit:

- a. AC Input

The ac supply cable connections are colour coded BROWN - LIVE, BLUE - NEUTRAL and YELLOW/GREEN - EARTH. If necessary, these wires should be connected to the ac supply via a suitable intermediate mains rated terminal block.

- b. DC Output

The dc output cable connections are colour coded RED - +24V and BLACK - 0V. These should be connected to the appropriate DC Input Card terminals.

It is recommended that the AC to DC Power Supply Unit is connected to the system earth using the earth stud provided at the rear of the unit. For additional electrical safety a Residual Current Device (RCD) type circuit breaker should be used at the supply source.

CHAPTER 4 INSTALLATION INSTRUCTIONS

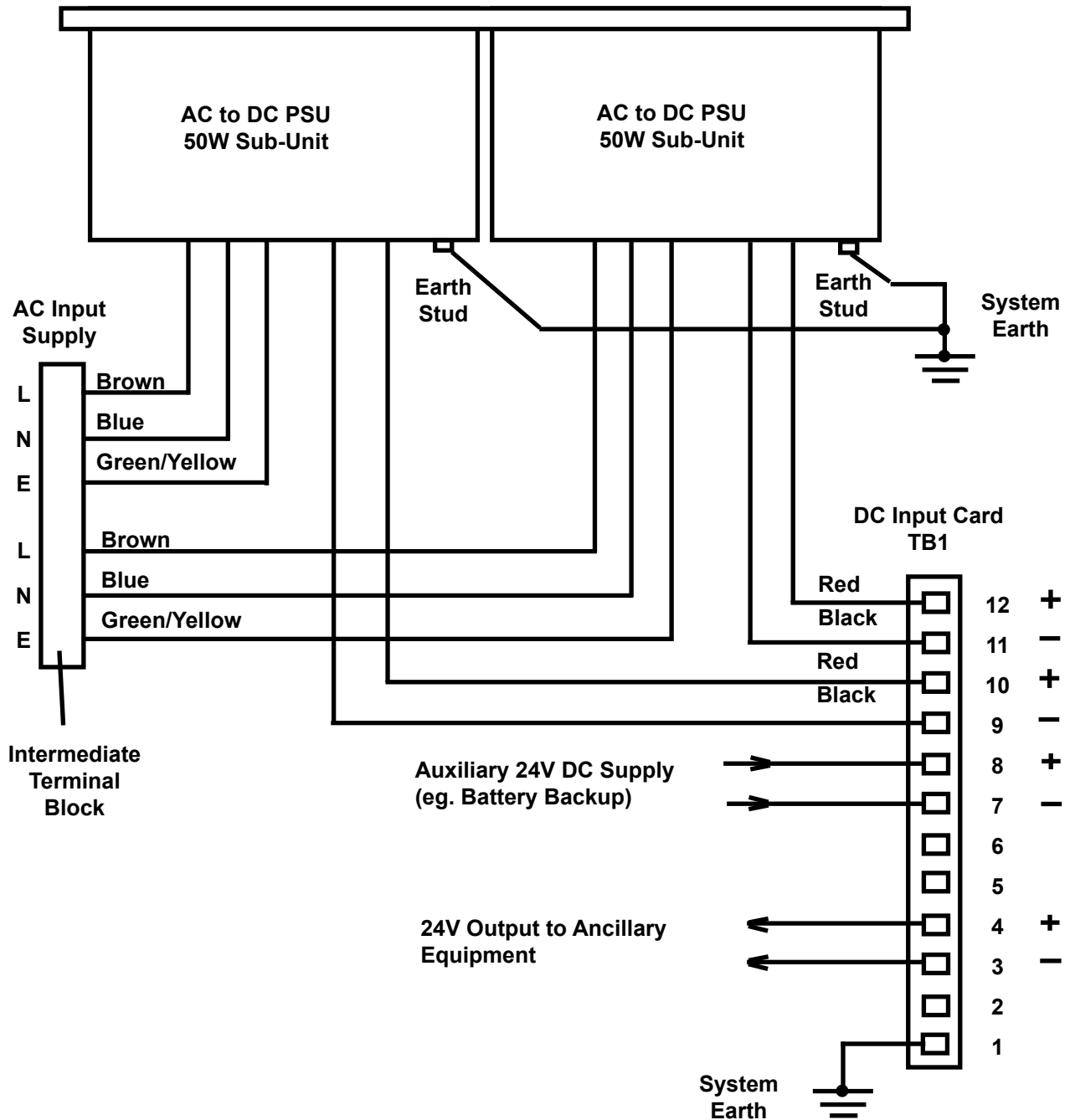

Twin Sub-Unit AC to DC Power Supply Connections to AC Supply, Earth and DC Input Card, Together with Auxiliary Battery Backup Supply

CHAPTER 4 INSTALLATION INSTRUCTIONS

17. UPGRADING THE AC TO DC POWER SUPPLY UNITS



WARNING

High voltages exist within the AC to DC Power Supply Unit. Disconnect from the ac supply for a period of at least five minutes before removing the top cover and carrying out any maintenance or upgrade operation.

17.1 General

There are two types of AC to DC Power Supply Unit, an 8-Way 50W and 16-Way 50W. The 8-way unit may be upgraded to 100W with the addition of a second 50W Switched Mode Module. The 16-way unit may be upgraded to 100W, 150W or 200W with the addition of 50W Switched Mode Module(s) and if necessary a 50W Sub Unit.

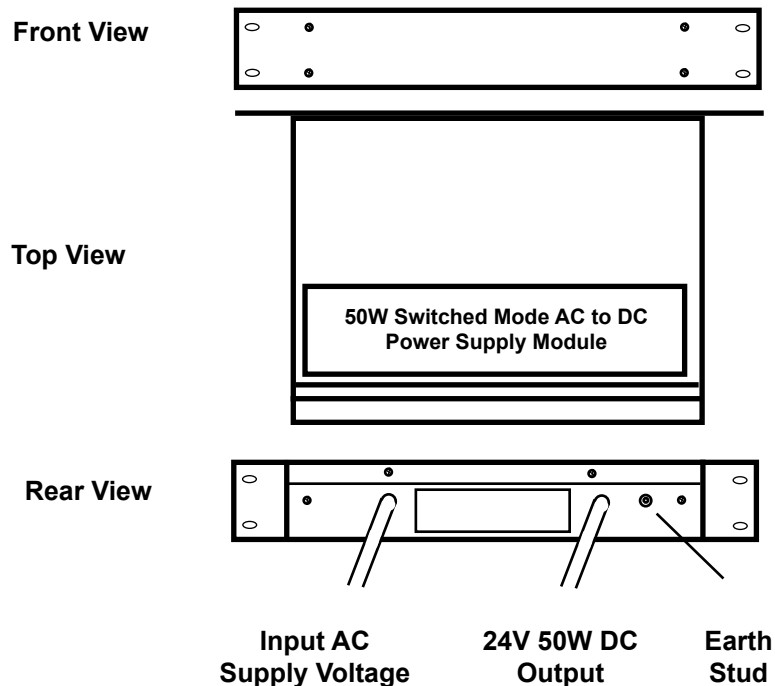

8-Way AC to DC Power Supply Unit (50W)

CHAPTER 4 INSTALLATION INSTRUCTIONS

Front View



Top View

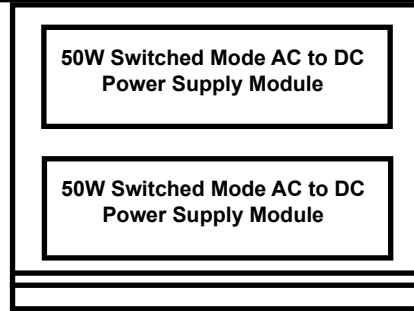

Rear View

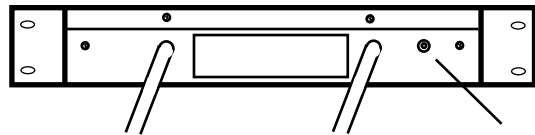

Input AC Supply Voltage 24V 100W DC Output Earth Stud

8-Way AC to DC Power Supply Unit (100W)

Front View



Top View

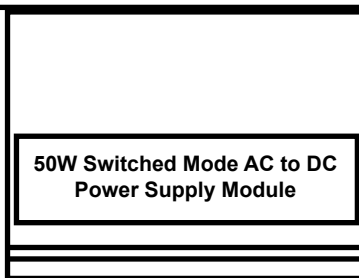

Rear View

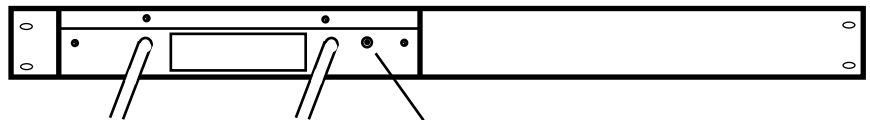

Input AC Supply Voltage 24V 50W DC Output Earth Stud

16-Way AC to DC Power Supply Unit (50W)

CHAPTER 4 INSTALLATION INSTRUCTIONS

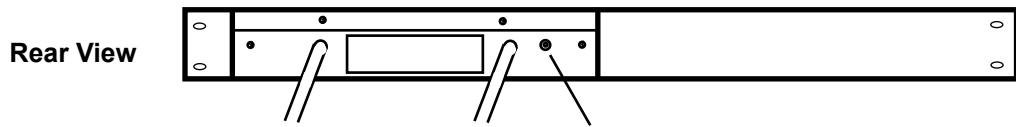
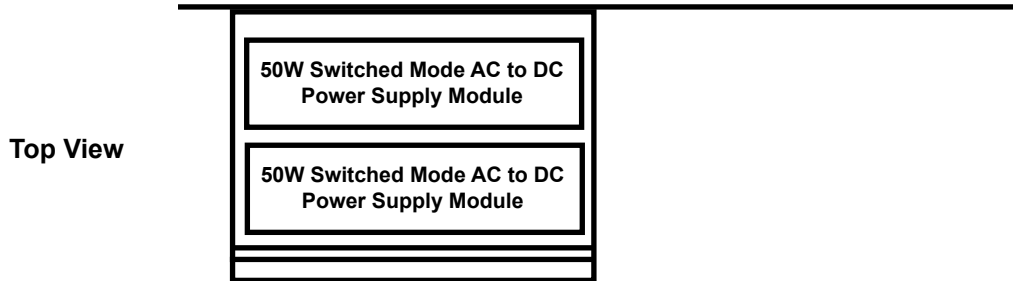

Input AC Supply Voltage 24V 100W DC Output Earth Stud

16-Way AC to DC Power Supply Unit (100W)

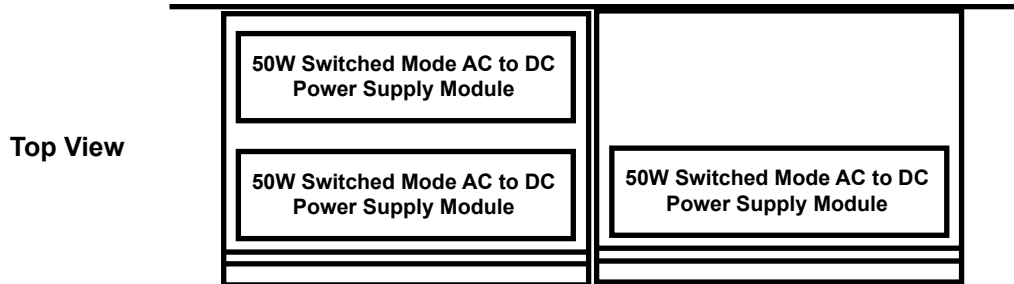

Input AC Supply Voltage 24V 100W DC Output Earth Stud Input AC Supply Voltage 24V 50W DC Output Earth Stud

16-Way AC to DC Power Supply Unit (150W)

CHAPTER 4 INSTALLATION INSTRUCTIONS

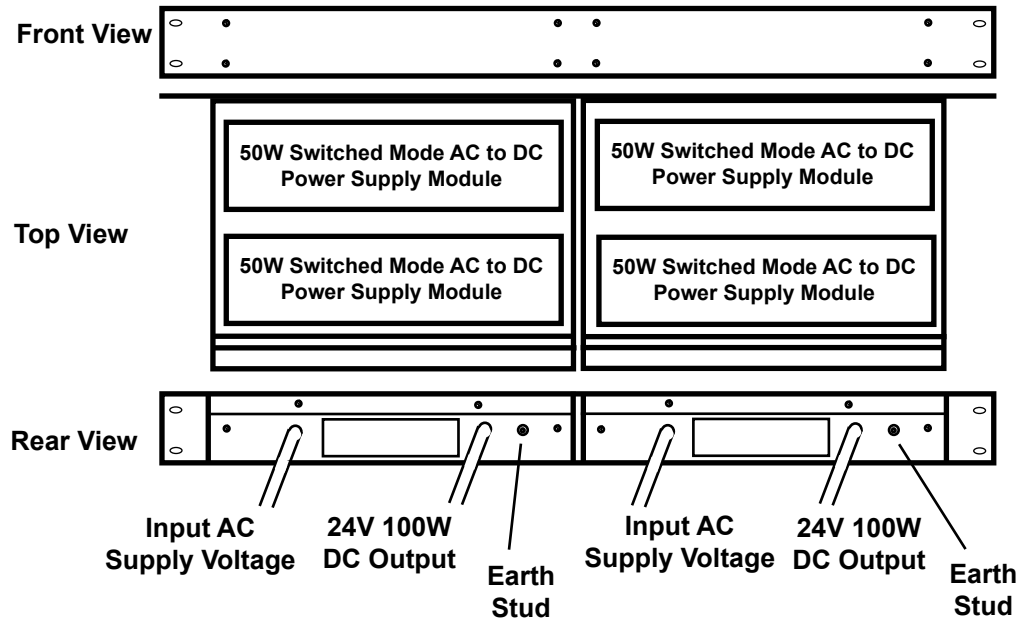

16-Way AC to DC Power Supply Unit (200W)

17.2 8-Way and 16-Way AC to DC Power Supply Unit Upgrade to 100W

To upgrade the 8-Way or 16-Way AC to DC Power Supply Units to 100W proceed as follows:

- (1) Remove and retain the screws securing the top cover of the power supply unit and lift the cover clear.
- (2) Cut and remove the retaining straps that secure the unused ac and dc connecting cables to the sub-unit chassis.
- (3) On the 50W Switched Mode Module to be added to the 50W Sub-Unit, remove and discard the four packing screws from the underside of the module, however, retain the long nuts and washers.
- (4) On the 50W Switched Mode Module to be added to the 50W Sub-Unit, ensure that the spacers under the printed circuit board are correctly located.

CHAPTER 4 INSTALLATION INSTRUCTIONS

- (5) Insert the module, with the same orientation as the already fitted module, into the vacant position inside the 50W Sub Unit and secure using the washers and long nuts retained in Step (3).
- (6) Connect the 50W Sub Unit second ac input and 24V dc output cable connectors to the ac input terminal CN1 and dc output terminal CN2 respectively on the added 50W Switched Mode Module as shown below:

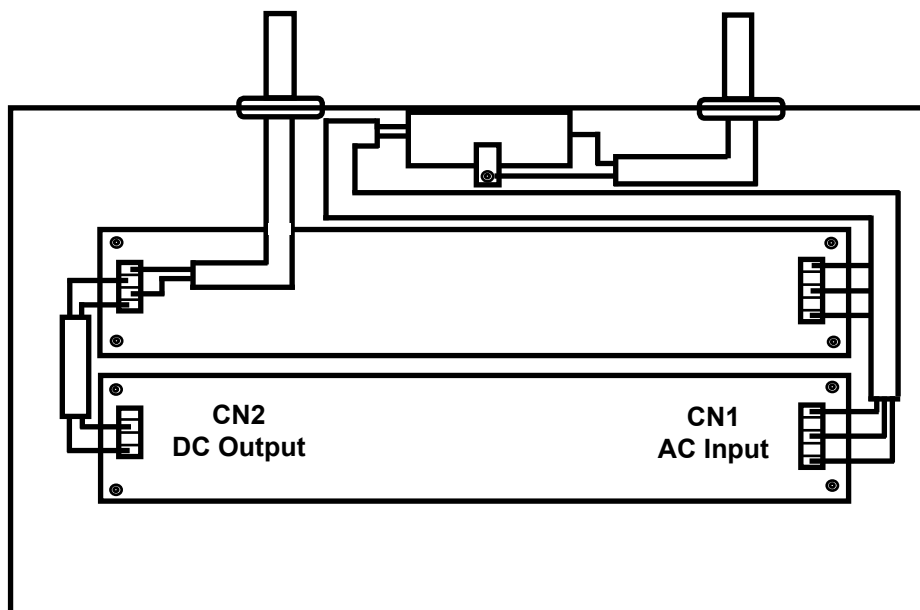

- (7) Refit the top cover.

17.3 16-Way AC to DC Power Supply Unit Upgrade to 150W or 200W

To upgrade the 16-Way AC to DC Power Supply Unit to 150W or 200W proceed as follows:

- (1) Fit a second 50W Sub unit, containing a 50W Switched Mode Module, to the 16-way AC to DC Power Supply Unit front panel using the fixings supplied.
- (2) When an upgrade to 200W is required, fit a further 50W Switched Mode Module into the new 50W Sub unit as indicated in Section 17.2.

CHAPTER 5 COMMISSIONING AND MAINTENANCE INSTRUCTIONS

5704F SERIES CONTROL SYSTEM CHAPTER 5 COMMISSIONING AND MAINTENANCE INSTRUCTIONS

CHAPTER 5 COMMISSIONING AND MAINTENANCE INSTRUCTIONS

CONTENTS

Section	Page	
1.	General	5-3
2.	Start Up Procedure	5-3
3.	System Check	5-5
4.	Maintenance	5-6
5.	Error Codes	5-8
	5.1 Power Up Self Test Errors	5-8
	5.2 Background Self Test Errors	5-9
	5.3 Input and Output Self Testing	5-10
	5.4 Power up And Self Test Error Summary	5-10
6.	FAULT FINDING	5-20

CHAPTER 5 COMMISSIONING AND MAINTENANCE INSTRUCTIONS



WARNING

High ac mains voltages may be present at the system power supply unit and at the relay terminals of the interface cards. Appropriate safety precautions must be taken when commissioning or servicing the system.

IMPORTANT

Commissioning and maintenance of the system should be carried out by trained authorised personnel only.

1. GENERAL

The following guide to commissioning and maintenance should be used in conjunction with the relevant instructions issued with the detectors being used.

2. START UP PROCEDURE

A detailed check of the system wiring should be carried out prior to this start-up procedure.

Start-up the system as follows:

- (1) Ensure that the system power supply is switched off.
- (2) Disconnect the power supply connections to the DC Input Card by removing the two part connector TB1 and TB2 if fitted.
- (3) Unscrew the two retaining screws used to secure the control cards and then, using the extraction tool, partially remove the cards from the rack so that there is no electrical connection between the control cards and the backplane.
- (4) Switch on the system power supply.
- (5) Check that a voltage of between 18V and 32V dc exists at the terminal block TB1 (and for individually power systems on each of the Hex Relay Interface Card terminals 35 and 36).
- (6) Switch off the power supply.
- (7) Reconnect the terminal block TB1 to the DC Input Card.

CHAPTER 5 COMMISSIONING AND MAINTENANCE INSTRUCTIONS

- (8) Switch on the system power supply.
- (9) Check that a voltage of between 21V and 32V dc still exists at the terminal block TB1.
- (10) Check that the Engineering Card front panel power on (⚡) green LED is illuminated and the unlocked (🔒) LED is flashing.
- (11) Push the control card in slot 1 fully into the rack so that it makes connection with the backplane and secure the card with the two securing screws.
- (12) Check that the front panel display operates, and that the control card front panel power lamp (⚡) and call engineer fault lamp (?) illuminate.
- (13) Observe the power up self test display sequence and ensure that the call engineer fault lamp (?) extinguishes at the end of the test period. If not refer to the power up fault finding guide.

If the control card has a Fire Status Panel fitted, verify the correct operation of the status panel lamps and sounder during the self test.

- (14) Check the operation of the inputs and outputs by verifying that all the front panel indicators, except the power lamp, are extinguished. If not refer to the fault finding section.
- (15) Repeat Steps (11) to (14) for the remaining control cards in the rack.
- (16) Reconnect the terminal block TB2 to the DC Input Card and test any optional Engineering Card modules in accordance with the relevant operating manual instructions.
- (17) Verify the alarm configuration for each channel by performing the system check outlined in Section 3.
- (18) Verify that the System 57 Control Cards and power supply are operating within the maximum specified operating temperature of +55°C.



CHAPTER 5 COMMISSIONING AND MAINTENANCE INSTRUCTIONS

3. SYSTEM CHECK

If required leave the connected detectors to stabilise for the period specified in the detector manual. Refer to the configuration printout supplied with the system and carry out the following checks:

- (1) Carry out a lamp test using the procedure outlined in Chapter 6, Section 7.

For each fire input:

- (2) Cause the input fire detector to produce the alarm condition using the appropriate means as specified in the detector operating instructions. (eg. by the application of artificial smoke, etc.)
- (3) Verify that the fire lamp () illuminates on the appropriate channel of the relevant Fire Control Card, and verify that any local switched and relay outputs associated with this input are correctly activated.
- (4) Reset the input using the procedure outlined in Chapter 6, Section 5. Where multiple detectors are connected to the same input, Steps 2, 3 and 4 should be repeated for each detector in turn.
- (5) Place a short circuit across the end of the line and verify that the fault lamp () illuminates on the appropriate channel of the relevant Fire Control Card.
- (6) Reset the input using the procedure outlined in Chapter 6 Section 5.

For Fire Cards performing master or grouped alarm functions:

- (7) Set one participating input channel at a time to the alarm condition and verify that the configured switched and relay outputs associated with the master or grouped alarm function are activated correctly.

For Fire Cards performing voted alarm functions:

- (8) Set an appropriate number of the participating input channels to the alarm condition and verify that the configured switched and relay outputs associated with the voted alarm function are activated correctly.
- (9) Repeat Step 8 until all participating input channels have been set to the alarm condition.

CHAPTER 5 COMMISSIONING AND MAINTENANCE INSTRUCTIONS

For systems using the remote inputs:

- (10) Set a fire input channel to the fire alarm condition and momentarily operate the remote:
 - a. ACCEPT (✓) switch and verify that the fire alarm condition is accepted.
 - b. SILENCE (🔇) switch and verify that the silence condition is enabled.
 - c. RESET (↩) switch and verify that the latched fire alarm is reset.

For systems using earth leakage detection:

- (11) Make a temporary connection between system ground and the power supply 0V line and verify that the earth leakage (⚡) lamp on the Fire Status Panel illuminates.

4. MAINTENANCE

To ensure that the system functions correctly, maintenance should be carried out on a regular basis as dictated by the site regulations and instructions for the type of detector being used.

The system should be maintained in a clean condition and keep free from dust and grease. A regular check should be made to ensure that each channel card is functioning correctly as follows:

- (1) Check and if necessary tighten all terminations to the DC Input Card, Hex Relay Interface Cards and if fitted to the Expansion Relay Card.
- (2) Check that the Engineering Card power on (🔌) green LED is illuminated and all other LEDs are extinguished.
- (3) Check the display of each channel in use, of every control card, indicates a normal reading with no error indications.
- (4) Carry out a lamp test using the procedure outlined in Chapter 6, Section 7.

CHAPTER 5 COMMISSIONING AND MAINTENANCE INSTRUCTIONS

For each fire input:

- (5) Set the input channel under test to the inhibit condition using the procedure outlined in Chapter 6, Section 10.
- (6) Cause the input fire detector to produce the alarm condition using the appropriate means as specified in the detector operating instructions. (eg. by the application of artificial smoke, etc.)
- (7) Verify that the fire indicator lamp (🔥) on the appropriate input is illuminated correctly.
- (8) Reset the input using the procedure outlined in Chapter 6, Section 5.
- (9) Where multiple detectors are connected to the same input, steps (6) to (8) should be repeated for each detector in turn.

Note: The walk test function as outlined in Chapter 6 Section 11 is available to simplify testing when only one operator is available.

- (10) Remove the inhibit condition from the input under test.

For each switched and relay output:

CAUTION

This test will cause the outputs of the system to be activated. The appropriate measures should be taken to warn personnel and prevent unwanted consequential actions.

- (11) Set the associated input to the fire alarm condition and verify the correct operation of the associated output devices.
- (12) Reset the input to the normal condition.

The System 57 control cards and Engineering Card carry out continual self checking of the integrity of the hardware, software and detector operation. In the event of a problem, and depending upon the type of problem, the control card will operate a fault (⚠) LED and/or a relay output.

CHAPTER 5 COMMISSIONING AND MAINTENANCE INSTRUCTIONS

5. ERROR DISPLAYS

5.1 Power Up Self Test Errors

At power up the power (⚡) and call engineer (?) lamps are illuminated and the fire card begins a self test. The self test progress can be monitored using the visual display sequences on the Fire Card and Fire Status Panel. In the event of a test failure, the display sequence is halted and an unambiguous indication of the fault condition is displayed. The tests and display sequence is as follows:

Test	Name	Description
1	Testing Commences	All channel select lamps are illuminated and remain on.
2	Software Failure	Output A, fault (△) lamp illuminated.
3	CPU Register Tests	Input 3, Inhibit lamp (⊘) illuminated.
4	CPU RAM Test	Input 3, fault lamp (△) illuminated.
5	CPU ROM Test	Input 3, fire lamp (🔥) illuminated.
6	CPU Timer Test	Input 1, inhibit lamp (⊘) illuminated.
7	EEPROM Checksum Test	Input 1, fault lamp (△) illuminated.
8	A/D Test	Input 1, fire lamp (🔥) illuminated.
9	Low Supply Voltage Test	Output B, fault lamp (△) illuminated.
10	High Supply Voltage Test	Input 4, inhibit lamp (⊘) illuminated.
11	FSP Keys Stuck Test	Input 4, fault lamp (△) illuminated.
12	Card Slot Test	Input 4, fire lamp (🔥) illuminated.
13	Display Test Only	Input 2, inhibit lamp (⊘) illuminated.
14	Display Test Only	Input 2, fault lamp (△) illuminated.
15	Display Test Only	Input 2, fire lamp (🔥) illuminated.
16	Testing Completed	All channel select lamps switch off.

CHAPTER 5 COMMISSIONING AND MAINTENANCE INSTRUCTIONS

A test of the Fire Status Panel indicators and audible output is performed in parallel with the Fire Card test sequence. Using the same step numbers as above the Fire Status Panel indicators are illuminated in turn as follows:

Test	Name
1,2	Power (⚡) LED.
3,4	Earth Fault (⚡) LED.
5,6	Walk Test (🚶) LED.
7,8	Silence (🔇) LED.
9,10	Inhibit (🚫) LED.
11,12	Fault (⚠️) LED.
13,14	Fire (🔥) LED.
15,16	Buzzer.

If any test fails, the call engineer (?) lamp is flashes and the diagnostic display remains stable. The test sequence can be restarted from the beginning by pressing the Fire Card's SELECT push-button for an extended reset.

The call engineer (?) lamp remains illuminated until testing has been successfully completed and the card has entered the normal monitoring mode.

5.2 Background Self Test Errors

Background self tests are carried out on the EEPROM, ROM, RAM, earth leakage and remote input hardware during normal operation for fault conditions. The backplane communications status is also monitored to ensure the integrity of the complex alarm functions.

In the event of a background test failure the call engineer (?) lamp is flashed in one of two modes:

- a. Fast Flash EEPROM fault.
ROM fault.
RAM fault
Backplane communications error
- b. Slow Flash Earth leakage.
(Fire Status Panel indicator is also illuminated).
Remote input fault.

CHAPTER 5 COMMISSIONING AND MAINTENANCE INSTRUCTIONS

The fast flash failure indication for background tests and backplane failures does not change on ACCEPT or RESET. It can however be cleared and the test restarted by pressing the Fire Card's SELECT push-button for an extended reset.

The slow flash indication for earth leakage and remote input faults must be ACCEPTED before it can be reset. Upon ACCEPT the call engineer (?) lamp stops flashing and remains illuminated. Once ACCEPTED, and provided the fault is no longer present, the fault conditions can be cleared by the RESET function.

5.3 Input and Output Self-Testing

During normal operation background checks are carried out on the condition of each fire loop input, switched output and the power supply voltage. In the event of a failure condition being detected the appropriate input or output zone fault (Δ) lamp or the card power (⚡) lamp will flash.

The flashing indication must be ACCEPTED before it can be reset. Upon ACCEPT the flashing indication stops flashing and remains on. Once ACCEPTED, provided the fault is no longer present, the fault conditions can be cleared by the RESET function.

5.4 Power Up and Self Test Error Summary

Operating errors within the system are indicated on the Control Card and Fire Status Panel LED indicators. The errors and their meaning are listed in the following sections. These sections also contain suggestions of the likely cause of the error and how this may affect the operation of the card.

Error Display:

This relates to the error indication given by the Control Card and Fire Status Panel LED Indicator lamps.

Card Status:

This refers to the condition of the control card operation.

Active: Means that the card is still processing signals from the connected sensor and, in the event of a fire condition, will still activate any configured alarm outputs.

Non Active: Means that it is not possible for the control card to generate any alarms, even in the event of a fire condition on any input.

CHAPTER 5 COMMISSIONING AND MAINTENANCE INSTRUCTIONS

Fault Signal:

This refers to the indication of a fault condition in response to the error condition.

Yes: Means that the appropriate zone front panel fault LED and any configured fault output will be operated.

No: Means that no fault indication is given. The error condition that causes these general warnings is of a minor nature and the channel card will continue to operate. The condition should however still be investigated.

Latch:

This refers to the condition of the error indication and any associated fault output.

Yes: Means that the control card will continue to display the error message until the condition causing the error has been cleared and the reset operation has been carried out.

No: Means that the error message will clear automatically once the condition causing the error message has cleared.

Conf.: Means that the latch/non-latch condition is configurable using the Engineering Interface Software. Refer to the configuration printout to determine this setting.

CHAPTER 5 COMMISSIONING AND MAINTENANCE INSTRUCTIONS

5.4.1 Power Up Error Guide

Error Display	Name and Meaning	Card Status	Fault Signal	Latch
<p>Output A fault (Δ) lamp illuminated and call engineer (?) lamp flashing.</p>	<p>Software Restarted</p> <p>This error indicates that a serious error occurred causing the control card software to re-boot.</p> <p>Environmental factors such as extreme temperatures and electromagnetic/ radio frequency interference should be investigated and the card configuration should be checked.</p> <p>The power up test can be restarted using an extended reset but this error could occur again. If the fault persists the card should be replaced.</p>	<p>Non Active</p>	<p>Yes</p>	<p>Yes</p>
<p>Input 3 inhibit lamp (\odot) illuminated and call engineer (?) lamp flashing.</p>	<p>Register Tests</p> <p>The registers are an integral part of the control card microprocessor. This failure indication is displayed if there are errors in the read/write register test during the system start up self test.</p> <p>The power up test can be restarted using an extended reset but this error could occur again. This is a serious card fault and, as such, the card needs to be replaced.</p>	<p>Non Active</p>	<p>Yes</p>	<p>Yes</p>
<p>Input 3 fault (Δ) lamp illuminated and call engineer (?) lamp flashing.</p>	<p>RAM Fault</p> <p>RAM is used to store the working values during operation.</p> <p>The RAM failure indication is displayed if there are errors in the read/write byte test during the system start up self test</p> <p>The power up test can be restarted using an extended reset but this error could occur again. This is a serious card fault and, as such, the card needs to be replaced.</p>	<p>Non Active</p>	<p>Yes</p>	<p>Yes</p>



CHAPTER 5 COMMISSIONING AND MAINTENANCE INSTRUCTIONS

Error Display	Name and Meaning	Card Status	Fault Signal	Latch
Input 3 fire (🔥) lamp illuminated and call engineer (?) lamp flashing.	<p>ROM Fault</p> <p>ROM is used to store the control card software program.</p> <p>The ROM failure indication is displayed if there are errors in the read byte test during the system start up self test</p> <p>The power up test can be restarted using an extended reset but this error could occur again. This is a serious card fault and, as such, the card needs to be replaced.</p>	Non Active	Yes	Yes
Input 1 inhibit (⊘) lamp illuminated and call engineer (?) lamp flashing.	<p>Timer Tests</p> <p>The timers are an integral part of the control card microprocessor. This failure indication is displayed if there are errors in the time out test during the system start up self test.</p> <p>The power up test can be restarted using an extended reset but this error could occur again. This is a serious card fault and, as such, the card needs to be replaced.</p>	Non Active	Yes	Yes
Input 1 fault (⚠) lamp illuminated and call engineer (?) lamp flashing.	<p>EEPROM Fault</p> <p>EEPROM is used to store the control card configuration data.</p> <p>The EEPROM failure indication is displayed if there is a checksum error or it is not possible to read the EEPROM during the system start up self test.</p> <p>The power up test can be restarted using an extended reset but this error could occur again. This is a serious card fault. If the card configuration can not be restored the card needs to be replaced.</p>	Non Active	Yes	Yes

CHAPTER 5 COMMISSIONING AND MAINTENANCE INSTRUCTIONS

Error Display	Name and Meaning	Card Status	Fault Signal	Latch
Input 1 fire (🔥) lamp illuminated and call engineer (?) lamp flashing.	<p>A/D Test Failure</p> <p>The analogue to digital converter (A/D) is an integral part of the control card microprocessor. This failure indication is displayed if a measurement error is detected during the system start up self test.</p> <p>The power up test can be restarted using an extended reset but this error could occur again. This is a serious card fault and, as such, the card needs to be replaced.</p>	Non Active	Yes	Yes
Output B fault (⚠️) lamp illuminated and call engineer (?) lamp flashing.	<p>Low Supply Voltage</p> <p>The system dc supply to the control card is measured at regular intervals to ensure correct operation.</p> <p>The low supply indication is displayed if there is a low voltage condition of less than 21V during the system start up self test. Check the supply voltage at the dc input card terminal block TB1.</p> <p>The error condition can be cleared using an extended reset after the power supply voltage has returned to within normal operating parameters.</p>	Non Active	Yes	Yes
Input 4 inhibit (🚫) lamp illuminated and call engineer (?) lamp flashing	<p>High Supply Voltage</p> <p>The system dc supply to the control card is measured at regular intervals to ensure correct operation.</p> <p>The high supply indication is displayed if there is a high voltage condition of more than 36V during the system start up self test. Check the supply voltage at the dc input card terminal block TB1.</p> <p>The error condition can be cleared using an extended reset after the power supply voltage has returned to within normal operating parameters.</p>	Non Active	Yes	Yes

CHAPTER 5 COMMISSIONING AND MAINTENANCE INSTRUCTIONS

Error Display	Name and Meaning	Card Status	Fault Signal	Latch
<p>Input 4 fault () lamp illuminated and call engineer (?) lamp flashing.</p>	<p>FSP Keys Stuck</p> <p>The Fire Status Panel keypad button status is checked during the system start up self test. If a button is continuously on this error will result.</p> <p>Check that the Fire Status Panel keypad is not damaged and clear the error condition using an extended reset. If the error occurs again then the Fire Status Panel should be replaced.</p>	<p>Non Active</p>	<p>Yes</p>	<p>Yes</p>
<p>Input 4 fire () lamp illuminated and call engineer (?) lamp flashing.</p>	<p>Card Slot Changed</p> <p>The card slot changed indication is given if a control card is moved to a different slot to the one it has been configured for.</p> <p>Depending upon the configuration moving cards to alternative slots may compromise the generation of multi-card alarms (eg. master, grouped and voted alarms). The alarm operation should always be checked whenever a card is moved.</p> <p>This error condition can be permanently cleared using an extended reset.</p>	<p>Non Active</p>	<p>Yes</p>	<p>Yes</p>

CHAPTER 5 COMMISSIONING AND MAINTENANCE INSTRUCTIONS

5.4.2 Self Test Error Guide

Error Display	Name and Meaning	Card Status	Fault Signal	Latch
<p>Call engineer (?) lamp fast flashing.</p>	<p>Communications Error</p> <p>Multi-card alarm functions (eg. master grouped and voted alarms) require continuous flow of data between cards via the backplane. The communication process is monitored and in the event of loss of data from a card participating in a multi-card function the host card will signal a communications error.</p> <p>Check that the all cards are fully inserted into the rack and are working correctly. Reset the error condition using an extended reset and perform a system check as outlined in Chapter 5 Section 3.</p> <p>If the error occurs again then the participant control cards should be changed one at a time for a known good card until the faulty card is identified.</p>	Active	No	Yes
<p>Call engineer (?) lamp fast flashing.</p>	<p>RAM Fault</p> <p>RAM is used to store the working values during operation.</p> <p>The RAM failure indication is displayed if the continuous integrity testing detects an error during normal operation.</p> <p>The error condition can be cleared using an extended reset but may occur again. This is a serious card fault and, as such, the card needs to be replaced.</p>	Non Active	Yes	Yes
<p>Call engineer (?) lamp fast flashing.</p>	<p>ROM Fault</p> <p>ROM is used to store the control card software program.</p> <p>The ROM failure indication is displayed if the continuous integrity testing detects an error during normal operation.</p> <p>The error condition can be reset using an extended reset but may occur again. This is a serious card fault and, as such, the card needs to be replaced.</p>	Non Active	Yes	Yes

CHAPTER 5 COMMISSIONING AND MAINTENANCE INSTRUCTIONS

Error Display	Name and Meaning	Card Status	Fault Signal	Latch
Call engineer (?) lamp fast flashing.	<p>EEPROM Fault</p> <p>EEPROM is used to store the control card configuration data.</p> <p>The EEPROM failure indication is displayed if the continuous integrity testing detects a checksum error during normal operation.</p> <p>The error condition can be cleared using an extended reset but may occur again. This is a serious card fault. If the card configuration can not be restored the card needs to be replaced.</p>	Non Active	Yes	Yes
Card power (⚡) lamp fast flashing.	<p>Low Supply Voltage</p> <p>The system dc supply to the control card is measured at regular intervals to ensure correct operation.</p> <p>The low supply indication is displayed if the continuous integrity testing detects a low voltage condition of less than 21V during normal operation. Check the supply voltage at the dc input card terminal block TB1.</p> <p>The error condition must be ACCEPTED before it can be RESET and can only be reset when the power supply voltage has returned to within normal operating parameters.</p>	Non Active	Yes	No
Card power (⚡) lamp fast flashing.	<p>High Supply Voltage</p> <p>The system dc supply to the control card is measured at regular intervals to ensure correct operation.</p> <p>The high supply indication is displayed if the continuous integrity testing detects a high voltage condition of more than 36V during normal operation. Check the supply voltage at the dc input card terminal block TB1.</p> <p>The error condition must be ACCEPTED before it can be RESET and can only be reset when the power supply voltage has returned to within normal operating parameters.</p>	Non Active	Yes	No

CHAPTER 5 COMMISSIONING AND MAINTENANCE INSTRUCTIONS

Error Display	Name and Meaning	Card Status	Fault Signal	Latch
<p>Call engineer (?) lamp slow flashing and FSP earth (⚡) lamp illuminated.</p>	<p>Earth Leakage</p> <p>When the earth leakage detection is enabled the isolation between the system dc supply to the control card and system ground is checked at regular intervals to ensure correct operation.</p> <p>If the earth leakage indication is displayed, check for shorts between the system power supply 0V and +24V dc inputs and ground. If none is found remove each control card in turn until the fault can be cleared and then check each detector loop connected to that card for ground faults.</p> <p>This error condition must be ACCEPTED before it can be RESET. It can only be reset when the earth leakage condition has been removed.</p>	Active	Yes	Yes
<p>Call engineer (?) lamp slow flashing.</p>	<p>Remote Input Fault</p> <p>When fault detection is enabled the remote input loop is checked at regular intervals to ensure correct operation.</p> <p>If the remote input fault indication is displayed check the continuity and correct EOL termination of the remote input loop.</p> <p>This error condition must be ACCEPTED before it can be RESET. It can only be reset when the remote input fault has been repaired.</p>	Active	Yes	Yes
<p>Zone x fault (Δ) lamp flashing if not accepted or steady on if accepted.</p>	<p>Input Zone Fault</p> <p>Each input loop is checked continuously to ensure correct operation.</p> <p>If the zone input fault indication is displayed check the input loop for short and open circuits and correct EOL termination. Check each detector is connected correctly and operating normally.</p> <p>This fault condition must be ACCEPTED before it can be RESET. It can only be reset when the input fault has been repaired.</p>	<p>Card Active</p> <p>Input not Active</p>	Yes	Yes

CHAPTER 5 COMMISSIONING AND MAINTENANCE INSTRUCTIONS

Error Display	Name and Meaning	Card Status	Fault Signal	Latch
<p>Output x fault (△) lamp flashing if not accepted or steady on if accepted.</p>	<p>Output Fault</p> <p>Each output loop is checked continuously to ensure correct operation.</p> <p>If the output loop fault indication is displayed, check the output fuse is not blown and the loop itself for short circuits, open circuits and correct EOL termination. Finally, check each device on the output is connected correctly and working properly.</p> <p>This fault condition must be ACCEPTED before it can be RESET. It can only be reset when the output fault has been repaired.</p>	<p>Card Active</p> <p>Output not Active</p>	<p>Yes</p>	<p>Yes</p>

CHAPTER 5 COMMISSIONING AND MAINTENANCE INSTRUCTIONS

6. FAULT FINDING

The following table provides a guide to diagnosing various conditions within the operation of System 57.

If possible the selected card diagnostic and configuration printout should be obtained as an aid to identifying card related fault conditions (see procedure outlined in Chapter 6 Section 12.3).

Fault	Action
The Engineering Card front panel power on (⚡) green LED extinguished.	Disconnect TB1 and measure the voltage between the +24V dc and 0V terminals. If the voltage is correct, remove the DC Input Card and check the fuse FS1. If the voltage is not correct, check the system power supply unit.
The Engineering Card front panel power on (⚡) green LED flashes at approximately two second intervals.	The dc input voltage is too low. Check dc voltage at the DC Input Card terminals.
The Engineering Card front panel power on (⚡) green LED flashes at approximately 0.5 second intervals.	There is a hardware fault. Switch power of and then on again. If problem persists, check the diagnostic printout for error codes
No dc voltage output from Power Supply Unit.	Check that the ac mains voltage is between 85V and 264V at the power supply ac connection wires. If yes, replace the 50W Power Supply Module.
No indications on a control card display.	Check that power is being applied to the control card from the backplane or Hex Interface Card as applicable and if the display still does not read, replace the control card.
An error indication is displayed.	Check the error summary tables in Section 5 for explanation.

CHAPTER 5 COMMISSIONING AND MAINTENANCE INSTRUCTIONS

Fault	Action
The fire card power (⚡) lamp is flashing.	<p>The power supply voltage is outside normal operating parameters of 21V to 36V. Check the supply voltage at the dc input card terminal block TB1.</p> <p>The error condition must be ACCEPTED before it can be RESET and can only be reset when the power supply voltage has returned to within normal operating parameters.</p>
An input zone fault (△) LED indicates a fault condition by flashing amber when not accepted or illuminating continuously.	<p>Check the input loop for short and open circuits and correct EOL termination. Check that each detector is correctly connected and operating normally.</p> <p>The error condition must be ACCEPTED before it can be RESET and can only be reset when the fault condition has been repaired.</p>
An input zone inhibit (⊘) LED indicates an inhibit condition by showing continuous amber.	<p>Insert the Engineers Key into the Engineering Card. Select the card and zone indicating the inhibit condition and operate the Fire Status Panel inhibit push-button. This should toggle the inhibit LED on and off.</p>
An input zone inhibit (⊘) LED indicates a walk test condition by flashing amber.	<p>Insert the Engineers Key into the Engineering Card. Select the card and zone indicating the walk test condition and operate the Fire Status Panel walk test push-button. This should toggle the walk test LED on and off.</p>
An output channel fault (△) LED indicates a fault condition by flashing amber when not accepted or illuminating continuously.	<p>Check the output fuse is not blown and then check the loop itself for short and open circuits and correct EOL termination. Finally, check each device on the output is connected correctly and working properly.</p> <p>The error condition must be ACCEPTED before it can be RESET and can only be reset when the fault condition has been repaired.</p>

CHAPTER 5 COMMISSIONING AND MAINTENANCE INSTRUCTIONS

Fault	Action
An input zone fire (🔥) LED indicates an alarm condition but no detectors are in alarm.	<p>Insert the Engineers Key into the Engineering Card. Press the ACCEPT and RESET push-buttons on the Fire Status Panel in sequence to reset the input.</p> <p>If the alarm condition returns check the loop wiring and detectors for faults.</p>
The Fire Status Panel earth leakage (⚡) indicator is illuminated together with the call engineer (?) indicator of one control card.	<p>Check for shorts between the system power supply 0V and +24V dc inputs and ground. If none is found remove each control card in turn until the fault can be cleared and then check each detector loop connected to that card for ground faults.</p> <p>The error condition must be ACCEPTED before it can be RESET and can only be reset when the fault condition has been repaired.</p>
The call engineer (?) lamp is flashing slowly but the earth leakage lamp on the Fire Status panel is not illuminated.	<p>Check the remote input connections for continuity and correct EOL termination.</p> <p>This error condition must be ACCEPTED before it can be RESET. It can only be reset when the remote input fault has been repaired.</p>
<p>There is no relay or switched output operation despite front panel indicators showing:</p> <ol style="list-style-type: none"> a. An input fire condition. b. An input fault condition. c. An input inhibit condition. d. An output fault condition. e. An earth leakage fault condition. f. A remote input fault condition. 	<p>If an alarm output is not signalled correctly:</p> <ol style="list-style-type: none"> a. Check to see if the zone is in the inhibited condition and if necessary remove the inhibit. b. Check to see if the silence condition is active. If necessary remove the silence condition. <p>Check to see if the type of relay card fitted can support the expected alarm.</p> <p>Check the channel card configuration using the Engineering Interface software to see that the relay is configured for the expected operation.</p> <p>Swop the relay interface card with another of the same type and repeat the testing.</p>

CHAPTER 5 COMMISSIONING AND MAINTENANCE INSTRUCTIONS

Fault	Action
<p>The control card call engineer (?) lamp is flashing quickly.</p>	<p>This most likely indicates a communications error. If the Engineering Card locked (■) LED is flashing follow the procedure outlined elsewhere in this section.</p> <p>Otherwise:</p> <p>Check that the all cards are fully inserted into the rack and are working correctly. Reset the error condition using an extended reset and perform a system check as outlined in Chapter 5 Section 3. If the error occurs again the participant control cards should be changed one at a time for a known good card until the faulty card is identified.</p> <p>If a communications error can not be found refer to Chapter 5 Section 5.4 to determine which other fault conditions could exist or replace the control card for a known good card.</p>
<p>The unlocked (■) LED is illuminated.</p>	<p>Remove the Engineering Key from the Engineering Card.</p>
<p>The unlocked (■) LED is flashing.</p>	<p>Check that all the control cards are fitted to the rack and are working.</p> <p>If a card has been removed deliberately, fit the Engineering Key into the Engineering Card socket and then remove the key again.</p> <p>Select each control card in turn and, using one of the Engineering Card ▲ or ▼ push-buttons, check that communications exist between the selected control card and Engineering Card by changing the selected channel.</p> <p>Check that the dc power supply is more than 16V.</p>

CHAPTER 5 COMMISSIONING AND MAINTENANCE INSTRUCTIONS

Fault	Action
The engineering push-buttons have no effect.	Select a channel card. Check that the Engineering card power on (⚡) LED is illuminated.

CHAPTER 6 OPERATING INSTRUCTIONS

5704F SERIES CONTROL SYSTEM CHAPTER 6 OPERATING INSTRUCTIONS

CHAPTER 6 OPERATING INSTRUCTIONS

CONTENTS

Section	Page
1. GENERAL	6-3
2. USER OPERATING ROUTINES	6-3
3. UNLOCKING THE ENGINEERING CARD	6-3
4. FORE STATUS PANEL ACCEPT	6.4
5. FIRE STATUS PANEL RESET	6.4
6. FIRE STATUS PANEL SILENCE	6.5
7. FIRE STATUS PANEL LAMP TEST	6.5
8. EXTENDED RESET	6.5
9. FOUR CHANNEL CONTROL CARD AND ZONE SELECT AND DE-SELECT	6-6
9.1 Four Channel Control Card Select	6-6
9.2 Four Channel Control Card Zone Select	6-6
9.3 Four Channel Control Card De-select	6-6
10. FOUR CHANNEL CONTROL CARD ZONE INHIBIT	6-7
11. FOUR CHANNEL CONTROL CARD ZONE WALK TEST	6-7
12. INITIATING A DIAGNOSTIC PRINTOUT	6-8
12.1 General	6-8
12.2 Rack Summary Printout	6-8
12.3 Card Configuration and Diagnostic Printout	6-10
13. CLOCK AND CALENDAR SETTING	6-12

CHAPTER 6 OPERATING INSTRUCTIONS

1. GENERAL

These operating instructions refer to the facilities available for general operation and maintenance of the system.

Facilities that have no effect upon the system performance are available without restriction. Facilities that may effect the way the system operates, can only be performed, by default, when the Engineering Card is unlocked by the Engineering Key.

Some functions operate across all fire cards in the rack, others operate on a single card or even a single zone.

2. USER OPERATING ROUTINES

The fire card operating routines are selected using push-buttons on the Engineering Card, Fire Status Panel or Four Channel Fire Control Cards. The following user operating routines may be performed depending on which push-button is pressed :

- Accept.
- Reset.
- Silence.
- Lamp Test.
- Extended Reset.
- Card and Zone Select and De-Select.
- Zone Inhibit.
- Zone Walk Test.
- Diagnostic printouts

3. UNLOCKING THE ENGINEERING CARD

To unlock the Engineering Card, plug the Engineering Key into the Engineering Card front panel socket. The Engineering Card Unlocked LED (■) will illuminate to indicate that it is unlocked.



Key

External Engineering Port





Engineering

Note: Inserting and then removing the Engineering Key resets the Engineering Card communications failure warning indication.

CHAPTER 6 OPERATING INSTRUCTIONS

4. FIRE SYSTEM ACCEPT

To acknowledge the status of the entire fire system briefly push the Fire Status Panel **ACCEPT** push-button. This will:

- a. Set all unaccepted fire conditions ( - flashing red) to the accepted state (.
- b. Set all unaccepted fault conditions ( - flashing amber) to the accepted state (.
- c. Cause the fire status panel audible alert sounder to enter the appropriate accepted mode.

Note: By default the Engineering Key is not required.

5. FIRE SYSTEM RESET

To reset the status of the entire fire system briefly push the Fire Status Panel **RESET** push-button. This will:

- a. Switch off the power supply for five seconds to the zone(s) with ACCEPTED fire or fault conditions and cause the ACCEPTED fire or fault conditions to be reset.
- b. Reset all other accepted fault indications provided the fault condition has cleared.

Notes: 1. By default the Engineering Key is not required.

2. The reset function only operates upon zones where the fire alarm and fault conditions that have previously been accepted.

3. Wait at least five seconds and observe the resulting system status to ensure that the normal operation has resumed.

IMPORTANT

It may be necessary to individually reset separately powered detectors using the procedure outlined in the detector manufacturers instructions.

CHAPTER 6 OPERATING INSTRUCTIONS

6. FIRE SYSTEM SILENCE

To set the entire fire system to the silenced mode of operation, briefly push the Fire Status Panel **SILENCE** push-button. This will:

- a. Switch off all the switched dc outputs that are configured to respond to the silence request.
- b. Deactivate all relays that are configured to respond to the silence request.
- c. Cause the fire status panel amber silence () LED to be continuously illuminated.

Notes: 1. By default the Engineering Key is not required.

2. It is not possible to silence an output unless the fire alarm and fault conditions on all associated zones have previously been accepted.

3. The silence condition is cancelled immediately if any other non-inhibited zone in the rack enters the fire condition.

7. FIRE SYSTEM LAMP TEST

To test all of the front panel LEDs of the fire system, briefly push the Fire Status Panel **LAMP TEST** push-button. This will:

- a. Cause all the front panel indicator LEDs on all Four Channel Fire Control Cards to be simultaneously illuminated for five seconds before returning to the previous operating state.
- b. Cause all the front panel indicator LEDs on all Fire Status Panel to be simultaneously illuminated for five seconds before returning to the previous operating state.

Note: The Engineering Key is not required.

8. FOUR CHANNEL CONTROL CARD EXTENDED RESET

Pressing the **SELECT** push-button of a Four Channel Fire Control Card for five seconds will perform an extended reset of the card. At the end of the five second period all four zone select LEDs on the card will illuminate and the push-button should be released. The extended reset is used when the call engineer (?) LED flashes quickly and performs the following functions:

CHAPTER 6 OPERATING INSTRUCTIONS

- a. Clears an EEPROM, ROM and RAM periodic self test that has failed and restarts the test.
- b. Clears a backplane communications error display on the reset card, instructing it to ignore communication failures from other cards.

CAUTION

The above indication may signify a serious fault on a Four Channel Fire Control Card which should be investigated thoroughly and if necessary the card should be replaced.

9. FOUR CHANNEL CONTROL CARD AND ZONE SELECT AND DE-SELECT

9.1 Four Channel Control Card Select

To select a Four Channel Fire Control Card for operations controlled from either the Fire Status Panel or Engineering Card, push the required card **SELECT** push-button for approximately 1.5 seconds until the zone 1 amber select LED on the card illuminates.

9.2 Four Channel Control Card Zone Select

Once a channel card has been selected, a particular zone can then be selected using the ▲ and ▼ push-buttons on the Engineering Card. The selected zone LED will be illuminated as the selection cycles between the different zones.

Note: Only one channel card and one zone can be selected at any one time. When selected the channel card operations are controlled by the Engineering Card and Fire status Panel keypads.

9.3 Four Channel Control Card De-select

Briefly push the channel card **SELECT** push-button to de-select a channel card and zone. Once de-selected all the zone LEDs will be extinguished.

Note: Certain user operations that have been initiated while the card was selected will remain active (eg. Zone Inhibit and/or Zone Walk Test).

CHAPTER 6 OPERATING INSTRUCTIONS

10. FOUR CHANNEL CONTROL CARD ZONE INHIBIT



With a channel card and zone selected, pushing the Fire Status Panel **INHIBIT** push-button toggles the selected zone between the non-inhibit state and the inhibit state. In the inhibited state:

- a. The zone inhibit (Ⓝ) amber LED will be continuously illuminated. The zone fire and fault status will be prevented from producing any local or multi-card output function or any Fire Status Panel indications.
- b. The inhibit relay, if configured, will be activated.
- c. The Fire Status Panel Card inhibit (Ⓝ) amber LED will be continuously illuminated.

Notes: 1. This function requires the Engineering Key to be fitted before it can be initiated but is NOT cancelled by removal of the Engineering Key.

2. More than one zone may be inhibited at any time.

3. An automatic reset condition occurs on the selected zone when the inhibit condition is switched off .

11. FOUR CHANNEL CONTROL CARD ZONE WALK TEST



WARNING

Unless the zone is inhibited before selecting the walk test, fire conditions generated during the walk test will cause the switched and voltage free outputs associated with this zone to be activated for at least five seconds.

With a card and zone selected, pushing the Fire Status Panel **WALK TEST** push-button toggles the selected zone in or out of the one man walk test mode. In the walk test mode:

- a. The zone inhibit (Ⓝ) amber LED will flash, and whenever the zone enters the alarm condition it will automatically be reset after five seconds.
- b. The fire status panel walk test (⚡T) amber LED will be continuously illuminated.

CHAPTER 6 OPERATING INSTRUCTIONS

- Notes:*
- 1. This function requires that the Engineering Key to be fitted before it can be initiated and is NOT cancelled by removal of the Engineering Key.*
 - 2. The walk test mode can not be selected if a non-inhibited fire condition exist anywhere in the system.*
 - 3. The walk test is cancelled immediately if any other non-inhibited zone in the rack enters the fire condition.*

12. INITIATING A DIAGNOSTIC PRINTOUT

12.1 General

A detailed printout of the status of a control card or a summary of the whole rack can be initiated using the Engineering Card. The data output is in ASCII text format at the serial port on the Engineering Card front panel.

The data is suitable for most RS232 serial printers or a PC terminal program (eg. Windows 95™ Hyper Terminal). The printer or terminal can be connected easily using the Engineering Interface Lead (05701-A -0120). The serial port settings required are: 9600 Baud, 8 Data bits, No Parity, 1 Stop Bit.

12.2 Rack Summary Printout

To output a rack summary printout proceed as follows:

- (1) Plug a RS232 printer or terminal into the Engineering Card serial port and configure the device settings to be those shown in Section 12.1.
- (2) Push the Engineering Card ▲ and ▼ push-buttons simultaneously. The Engineering Card locked (■) lamp will flash while the data is output.

CHAPTER 6 OPERATING INSTRUCTIONS

An example of a Rack Summary Printout:

```
18/04/99 09:05 ** Rack info. **
Card type      : Enhanced engineering card
S/W           : v02.20
Eng key override : Inactive
Customer name  : Honeywell Analytics
Customer site  : B Block
Serial number  : 12345A17
--
Slot          : 08
Card type     : 5701
S/W          : v01.10
Serial number : 12345A08
Tag          : Boiler Room
Gas         : Propane
Range       : 0 - 100
Active alarms :
--
Slot          : 10
Card type     : 5704 Bridge
S/W          : v01.50
Serial number : 12345A10
Tag          : Car Park 1
Tag          : Front Stairs
Tag          : Back Stairs
Tag          : Ceiling
Gas         : Methane
Range       : 0 - 100
Active alarms :
--
Slot          : 13
Card type     : 5704 Fire
S/W          : v01.00
Serial number : 12345A13
Tag          : Zone 1
Tag          : Zone 2
Tag          : Zone 3
Tag          : Zone 4
Active alarms : FT
```

Note: The information printed will vary slightly depending upon the type of control cards fitted.

CHAPTER 6 OPERATING INSTRUCTIONS

12.3 Card Configuration and Diagnostic Printout

To output a configuration and diagnostic printout for a control card proceed as follows:

- (1) Plug an RS232 printer or terminal into the Engineering Card serial port and configure the device settings to be those shown in Section 12.1.
- 2) Select the required control card using the procedure outlined in Section 9.
- 3) Push the Engineering Card ▲ and ▼ push-buttons simultaneously. The Engineering Card locked (🔒) lamp will flash while the data is output.

An example of the Card Configuration and Diagnostic Printout:

```
18/04/99 16:21 ** Card Info **
Slot           : 13
Card Type      : 5704F
S/W           : V1.00
Serial Number  : 12345A13
**
** General Status
Card           : Good
Power Supply   : Good
Remote Input   : Normal
Earth Leakage  : Normal
**
** Input Channel 1
Tag           : Zone 1
Sensor Type    : Generic
Last Fire     : 16/08/98 12:15
Fire Count    : 14
Status: Normal
**
** Input Channel 2 .....
** Input Channel 3 .....

** Input Channel 4
Tag           : Zone 4
Sensor Type    : Generic
Last Fire     : None
Fire Count    : 0
Status        : FAULT - Short Circuit
**
```

CHAPTER 6 OPERATING INSTRUCTIONS

```
** Output Channel 1
Status           : OFF
Silence          : Enabled
Events assoc'd to this output:
- Fire for chan 1,2,3,4
**

** Output Channel 2
Status           : FAULT - Fuse open circuit
Silence          : Disabled
Events assoc'd to this output:
- Complex Fire
**

** Relay Configuration
RL01             : Norm.Energised
Events assoc'd to this relay:
- Card Fault
- Fault for chan 1,2,3,4
- Fault for outputs 1,2
- Remote Input Fault
- Earth Leakage Fault

RL02 .....
RL03 .....
RL04 .....
RL05 .....

RL06             : Norm.De-energised
Events assoc'd to this relay:
- Fire for chan 2
**

** Complex Alarm Configuration
Participating channels:
- Slot 1         : 1,2,3,4
- Slot 4         : 1,3
Vote Count:
- Sensor Fault = 1
- Fire = 3
- A1 = 2
- A2 = 2
- A3 = 1
Vote Compensation:
- Faults count as alarms
**

** End of card printout **
```

CHAPTER 6 OPERATING INSTRUCTIONS

13. CLOCK AND CALENDAR SETTING

The system clock and calendar information is held by the Engineering Card. It is not possible to adjust the clock or calendar using the Fire Cards, this function must be performed using either a gas control card or the Engineering Interface Software. Refer to the appropriate operating instructions for more details.

CHAPTER 7 SPECIFICATION

5704F SERIES CONTROL SYSTEM CHAPTER 7 SPECIFICATION

CHAPTER 7 SPECIFICATION

CONTENTS

Section	Page
1. APPROVALS AND STANDARDS	7-3
2. ENVIRONMENTAL	7-3
3. RFI/EMC CONFORMITY	7-3
4. POWER SUPPLIES	7-3
5. INDIVIDUAL MODULE PARAMETERS	7-3
5.1 Hex Relay Interface Card	7-3
5.2 Fire Relay Interface Assembly	7-4
5.3 Four Channel Fire Control Card	7-4
5.4 Four Status Panel	7-6
5.5 Engineering Card	7-7
5.6 DC Input Card	7-8
6. CABINET ASSEMBLIES	7-8
7. RACK ASSEMBLIES	7-10
8. POWER SUPPLY UNITS	7.12

CHAPTER 7 SPECIFICATION

1. APPROVALS AND STANDARDS

Designed to comply with:

EN54-2 Fire Detection and Fire Alarm System Part 2: Control and Indicating Equipment.

2. ENVIRONMENTAL

Operating Temperature: -5°C to +55°C.

Storage Temperature: -25°C to +55°C.

Humidity: 0 to 90% RH. Non-condensing.

3. RFI/EMC CONFORMITY

EN50081 Part 1 and Part 2 EMC/RFI (Generic Emission).
EN50082 Part 1 and Part 2 EMC/RFI (Generic Immunity).

Radiated Susceptibility: 10V/m over 50kHz to 1GHz.

4. POWER SUPPLIES

Power Consumption : Dependant upon configuration.
(System) See Chapter 4, Section 5.

External DC Power Supply: 21V to 32V to DC Input Card.

External AC Power Supply: 85V to 264V at 47Hz to 440Hz.
(Using optional AC to DC PSU).

5. INDIVIDUAL MODULE PARAMETERS

5.1 Hex Relay Interface Card (05704-A-0123)

Dimensions:	Height	132mm.
	Width	25mm.
	Depth	119mm.

Weight: 240g.

Power: 2.4W (maximum) 1.7W (typical).

Relays: 6 x SPCO.

CHAPTER 7 SPECIFICATION

Relay Operation:	Selectable. Latching/Non-Latching. Energised/De-Energised.
Relay Contact Rating:	5A at 110V/250V ac (non inductive). 5A at 32V dc (non- inductive).
Field Terminals:	2.5mm ² (14 AWG).

5.2 Fire Relay Interface Assembly (05704-A-0133)

Consists of a Expansion Relay Card fitted to a Hex Relay Interface Card.

Dimensions:	Height	132mm.
	Width	52mm.
	Depth	122mm.
Weight:	510g.	
Power:	7W (maximum)	4W (typical).
Relays:	10 x SPCO. 4 x SPST. 2 x DPCO.	
Relay Operation:	Selectable. Latching/Non-Latching. Energised/De-Energised.	
Relay Contact Rating:	5A at 110V/250V ac (non inductive). 5A at 32V dc (non- inductive).	
Field Terminals:	2.5mm ² (14 AWG).	

5.3 Four Channel Fire Control Card (05704-A-0146)

General:	4 Fire Zone Inputs. 2 Switched DC Outputs. Single 3 Function Remote Input. Up to 16 Configurable Relay Outputs.	
Front Panel LED Indicators:		
Per Zone:	Fire Fault Inhibit Select	Red. Amber. Amber. Amber.
Per Output:	Fault	Amber.
Others:	Power Call Engineer	Green. Amber.

CHAPTER 7 SPECIFICATION

Front Panel Push-Button:	Single tactile rubber button for Zone Select and Extended Reset.
DC Supply:	21V to 32V dc. Link selectable between backplane and interface card inputs.
Power Consumption:	7.5W (typical). 8.5W (maximum).
Zone Drive:	
Type:	Four independent 2-wire current sensing loop inputs with fault monitoring.
Loop Supply:	System dc supply, voltage limited to +24V dc maximum.
Loop Sense Impedance:	220 ohms with a link selectable series 330 ohms I.S. barrier equivalent resistance.
Maximum line resistance:	100 ohms.
End of Line Termination:	5.1k ohms (typical).
Fault Detection:	Open circuit. Short circuit.
Zone Input Alarm Points (Default Settings):	
Open Circuit Fault:	0mA to 3mA.
Normal Operation:	3mA to 10mA.
Fire Alarm:	10mA to 30mA.
Short Circuit Fault:	30mA to 50mA.
Alarm Set Point Resolution:	In 1mA steps.
Output Circuits:	
Type:	Two independent 2-wire fused and switched dc output loops with fault monitoring.
Output Voltage:	System dc supply.
Output Current:	1A maximum.

CHAPTER 7 SPECIFICATION

Fuse Type and Rating: 1A quick blow 20 x 5mm glass.
(eg. Bussman Part No. S500-1A).

End of Line Termination: 22k ohms.

Fault Detection: Open circuit.
Short circuit.
Fuse failure.

Remote Input Facilities:

Type: Single 2-wire three function loop with
fault monitoring.

Switch Resistance Values: Remote Accept 10k ohms.
Remote Reset 4.7k ohms.
Remote Silence 2.2k ohms.

End of Line Termination: 22k ohms.

Fault Detection: Open circuit.
Short circuit.

Earth Leakage Monitoring: Link selectable, symmetrical ground bias
impedance monitoring between system
0V and +24V dc lines.

Dimensions: Height 132mm
Width 25mm.
Depth 172mm

Weight: 160g.

5.4 Fire Status Panel (05704-A-0148)

Front Panel LED Indicators:

Common Indicators:	Fire	Red.
	Fault	Amber.
	Inhibit	Amber.
	Select	Amber.
	Walk Test	Amber.
	Earth Fault	Amber.

Others:	Power	Green.
---------	-------	--------

CHAPTER 7 SPECIFICATION

Front Panel Audible Alarm:

Type:	Piezo sounder.	
Audible Frequency:	4kHz (typical).	
Modes:	Fire	Continuous.
	Fault	1 second on. 1 second off.
	Accept Fire:	1 second on. 10 seconds off.
	Accept Fault	1 second on. 30 seconds off.

Front Panel Keypad:

Type:	Six tactile rubber push-buttons.
Common Functions:	Accept. Silence. Reset. Lamp Test.
Zone Functions:	Inhibit. Walk Test.

DC Supply: Power provided by Four Channel Fire Control Card.

Power Consumption: 0.2W (typical).
0.9W (maximum).

Dimensions: Height 132mm
Width 25mm.
Depth 20mm
(excluding cable)

Weight: 37g.

5.5 Engineering Card

LEDs: Power On (⚡ - Green LED).
Unlocked (🔒 - Red LED).

Push-Button:

Operating: Up (▲) and Down (▼).
Reject (✘) and Accept (✓).
Print (Up and Down together).

CHAPTER 7 SPECIFICATION

Functions:	Bead mA Zero Span Inhibit	Alarms Signal 1st Span Clock
Power Consumption:	1.5W (typical). See rack details.	
DC Supply:	18V to 32V dc.	
Dimensions:	Height: Width: Depth:	132mm. 25mm. 170mm.
Weight:	152g.	

5.6 DC Input Card

DC Supply:	18V to 32V dc.	
Dimensions:	Height: Width: Depth:	112mm. 25mm. 102mm.
Weight:	129g.	
Fuse Rating:	10A Anti-surge. 1¼ x ¼ inches.	
Field Terminals:	2.5mm ² (14 AWG).	

6. CABINET ASSEMBLIES

Material:	Mild steel.	
Weight: 8-way:	10.0kg	
16-way:	13.5kg.	
Gland Entries:	Knockout.	
8-way	2 x M25 6 x PG11 8 x M20 2 x PG16	
16-way	3 x M25 10 x PG11 16 x M20 4 x PG16	

CHAPTER 7 SPECIFICATION

Cabinet Dimensions:

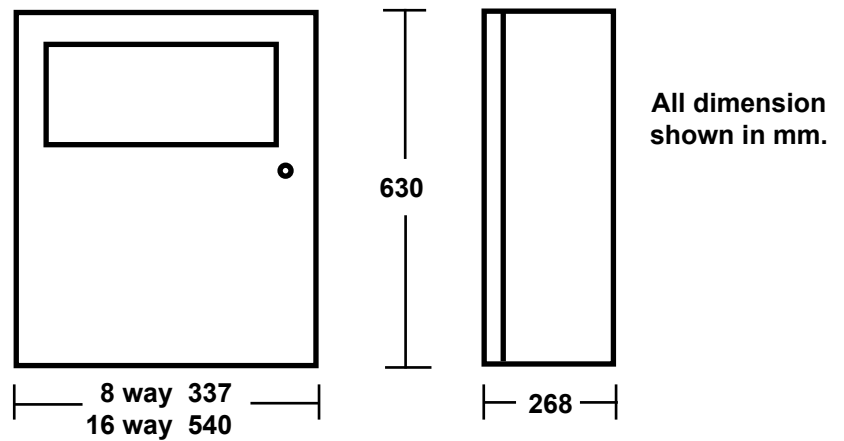

Wall Mounting Bracket Hole Locations

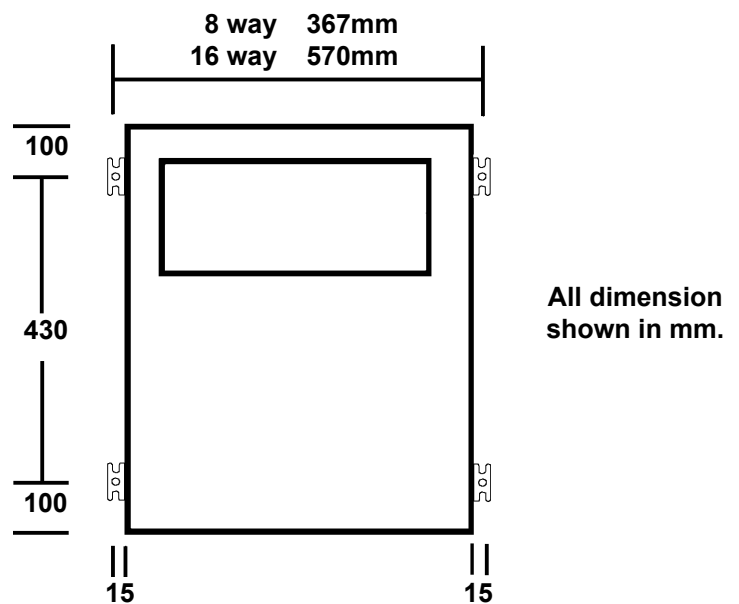

CHAPTER 7 SPECIFICATION

Cabinet Mounting Brackets

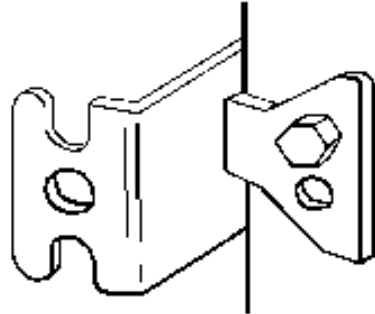

All dimension shown in mm.

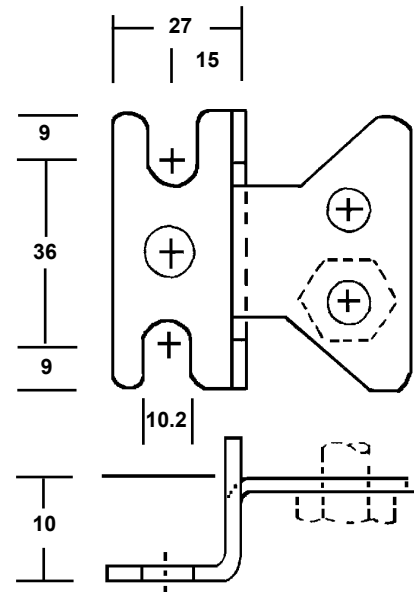

Hinged:	Left hand side.
Lock:	Right hand side.
Colour:	RAL 7015 slate grey.
Mounting Bracket Holes:	10mm (0.4") diameter.
Rack Mounting:	Universal 19 inch profile. 19 inch width and half 19 inch width.
Earthing Points:	Main cabinet M6. Door M5.
Mounting Plate:	Galvanised steel.
7. RACK ASSEMBLIES	
Rack Assemblies Contains:	Engineering Card. DC Input Card. Interconnect Cable (front access rack only).
Material:	Galvanised steel.
Earthing Point:	M5 stud.
Mounting:	Universal 19 inch and half width (19 inch mounting).
Power Consumption:	1.5W.
Supply Voltage:	18 to 32V dc.

CHAPTER 7 SPECIFICATION

Weight: (including Engineering Card and DC Input Card)

- 16 Way Front Access: 5.8kg.
- 16 Way Rear Access: 4.1kg.
- 8 Way Front Access: 3.9kg.
- 8 Way Rear Access: 2.8kg.

Table of Sizes (mm)

Rack Assembly	A	B	C	D	E	Depth
8 Way Rear Access	279.4	261.9	57.0	37.8	132.5	287.6
8 Way Front Access	279.4	261.9	190.5	37.8	266.0	217.6
16 Way Rear Access	482.6	465.1	57.0	37.8	132.5	287.6
16 Way Front Access	482.6	465.1	190.5	37.8	266.0	217.6
Panel Cutout Clearance						
8 Way 16 Way	Width: 247 450		Height as column E as column E			

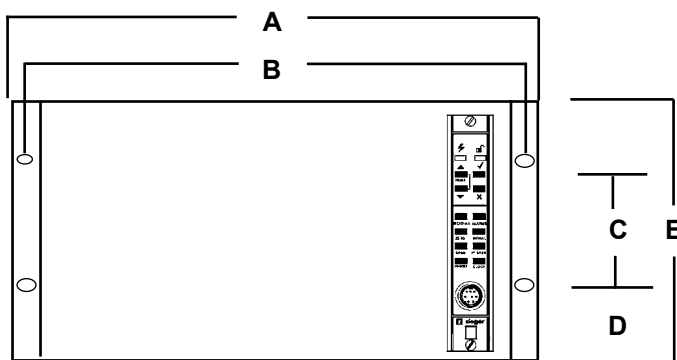

(holes 6mm diameter)

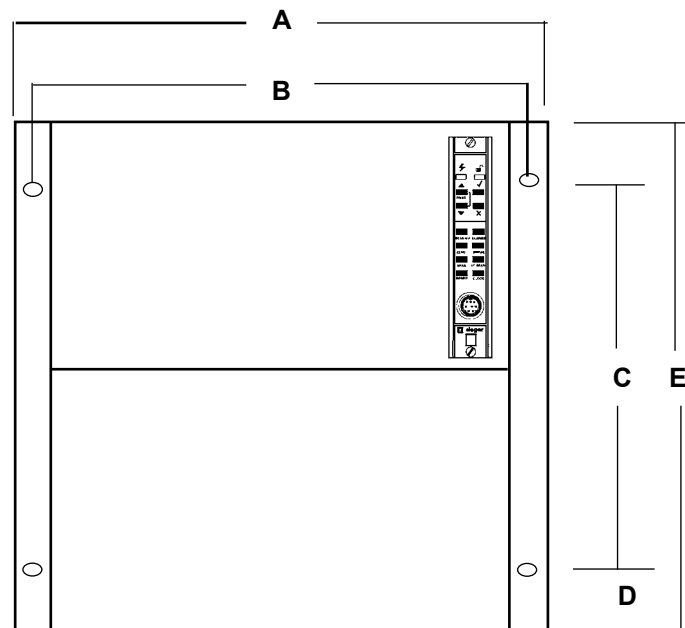

CHAPTER 7 SPECIFICATION

8. POWER SUPPLY UNITS

Mounting:	Universal 19" and half 19" mounting.
Supply Voltage:	85V to 264V ac 47Hz to 440Hz. 110V to 340V dc. (For information on dc input contact Zellweger Analytics).
Inrush Current:	Typically 30A at 230V input on full load per 50W Module.
Leakage Current:	0.75mA maximum per 50W Module.
Overload Protection:	Operates at more than 105% of rated full load and recovers automatically.
Safety Approvals:	50W Module approved to UL1950, IEC950, CSA 22.2 No 234.
Output Voltage:	24V \pm 10% dc.
Output Configurations:	
Half 19" Rack:	50W or 100W.
Full 19" Rack:	50W, 100W, 150W or 200W.
Earthing Point:	M5 stud.
Weight:	
Half 19" Rack 50W:	900g.
Full 19" Rack 50W:	960g.
50W Module:	230g.
Sub Unit:	815g.

CHAPTER 7 SPECIFICATION

Dimensions:

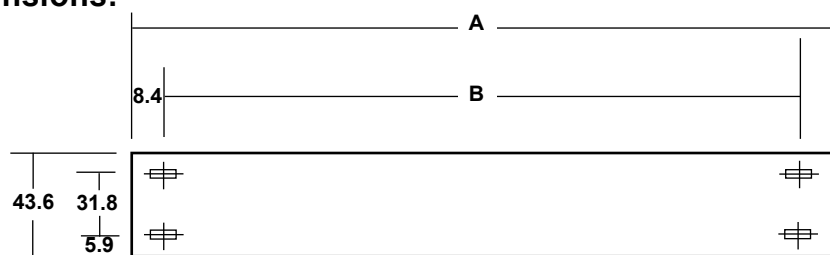

Mounting holes = 7mm

			Width	Height	Depth
			8 Way	279.4	261.9
16 Way	482.6	465.1	443	41	190

USER NOTES

CHAPTER 8 ORDERING INFORMATION

5704F SERIES CONTROL SYSTEM CHAPTER 8 ORDERING INFORMATION

CHAPTER 8 ORDERING INFORMATION

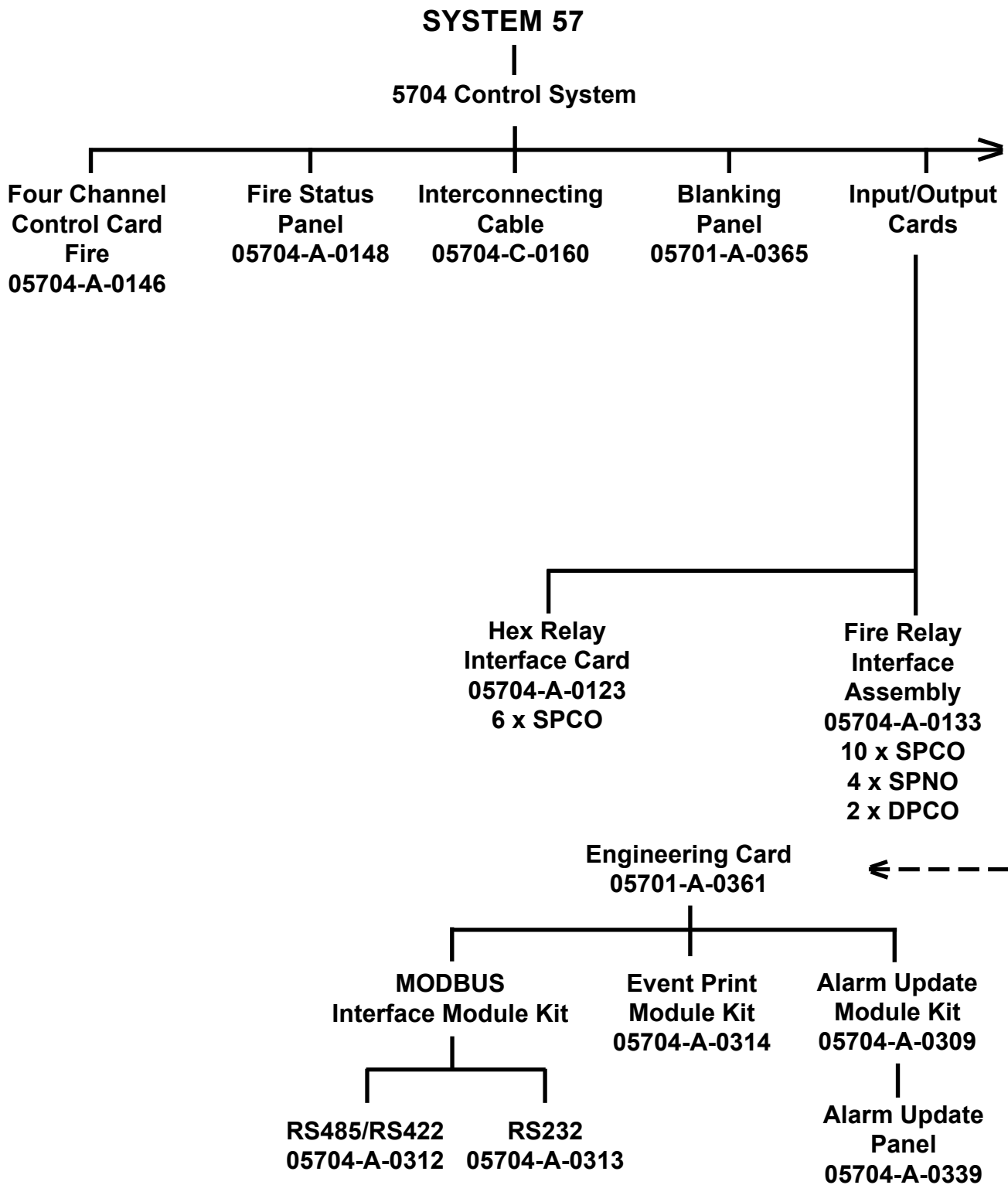

5701 Control System Parts - Sheet 1

CHAPTER 8 ORDERING INFORMATION

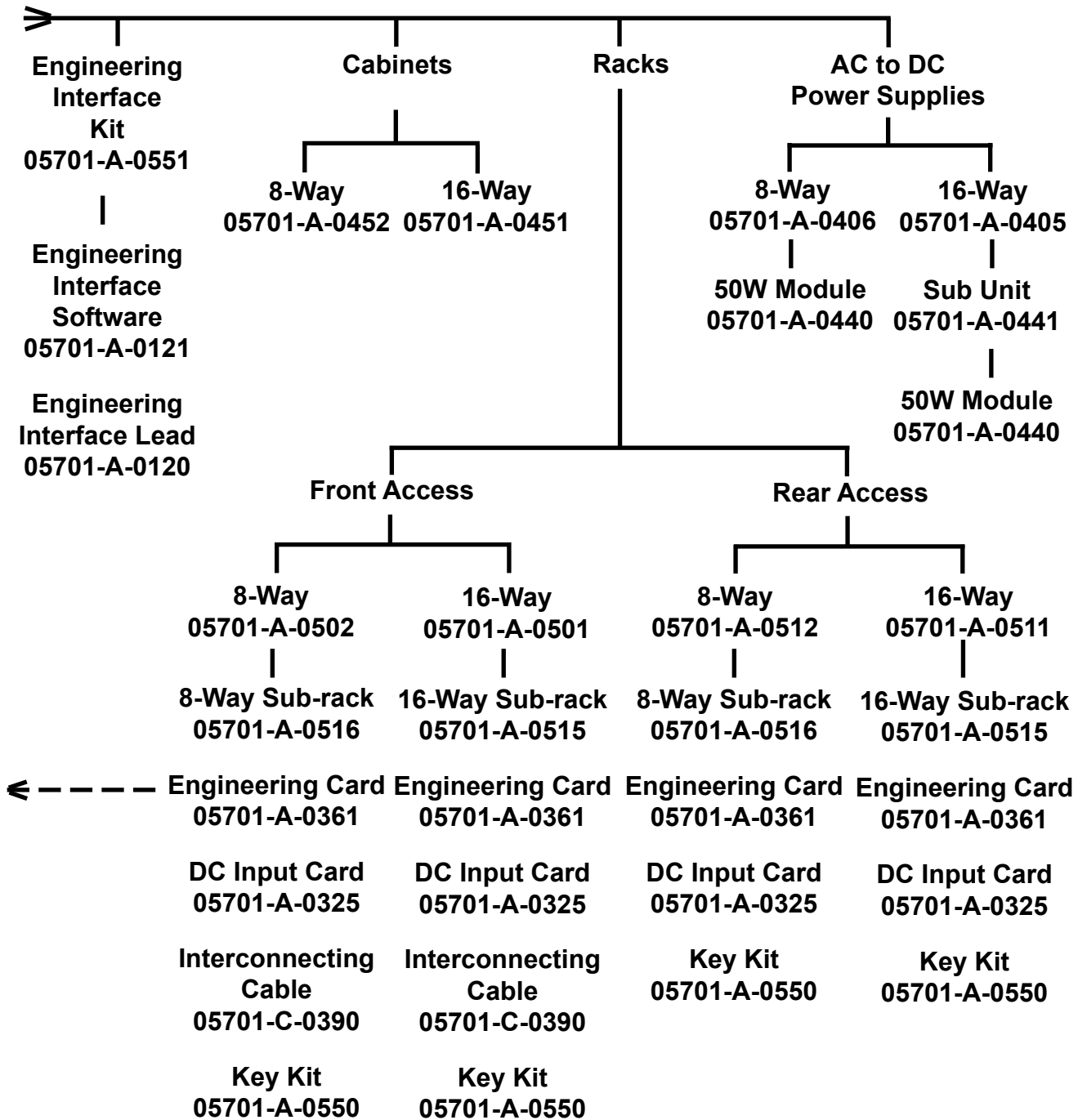

5701 Control System Parts - Sheet 2

USER NOTES

Find out more at:

www.honeywellanalytics.com

Contact Honeywell Analytics:

Europe, Middle East, Africa

Life Safety Distribution GmbH
Javastrasse 2
8604 Hegnau
Switzerland
Tel: +41 (0)44 943 4300
Fax: +41 (0)44 943 4398
gasdetection@honeywell.com

Customer Service:

Tel: 00800 333 222 44 (Freephone number)
Tel: +41 44 943 4380 (Alternative number)
Fax: 00800 333 222 55
Middle East Tel: +971 4 450 5800 (Fixed Gas Detection)
Middle East Tel: +971 4 450 5852 (Portable Gas Detection)

Russia

АО «ХОНЕВЕЛЛ»
121059, Россия, Москва
ул. Киевская, д. 7, 8 этаж
Тел. +7 (495) 796 9800
Факс +7 (495) 796 9893/94
info@honeywell.ru

Americas

Honeywell Analytics Inc.
405 Barclay Blvd.
Lincolnshire, IL 60069
USA
Tel: +1 847 955 8200
Toll free: +1 800 538 0363
Fax: +1 847 955 8210
detectgas@honeywell.com

Asia Pacific

Honeywell Analytics Asia Pacific
7F SangAm IT Tower, 434 World cup buk-ro,
Sangam-dong, Mapo-gu,
Seoul 152-729
Korea
Tel: +82 (0)2 6909 0300
Fax: +82 (0)2 2025 0328
India Tel: +91 124 4752700
analytics.ap@honeywell.com

Technical Services

EMEA: HAexpert@honeywell.com
US: ha.us.service@honeywell.com
AP: ha.ap.service@honeywell.com

www.honeywell.com

Issue 01 03/1999

H_MAN0546

5704F Control System

05704M5002

© 2009 Honeywell Analytics

Honeywell