

# Getting Started With Your DeltaV™ Digital Automation System





© 1996 - 2006 Fisher-Rosemount Systems, Inc. All rights reserved. Unauthorized duplication, in whole or in part, is prohibited.

Printed in UK

Emerson, Emerson Process Management, the Emerson Process Management Design, DeltaV, the DeltaV design, and PlantWeb are marks of one of the Emerson Process Management group of companies. All other marks are property of their respective owners. The contents of this publication are presented for informational purposes only, and while every effort has been made to ensure their accuracy, they are not to be construed as warranties or guarantees, expressed or implied, regarding the products or services described herein or their use or applicability. All sales are governed by our terms and conditions, which are available on request. We reserve the right to modify or improve the design or specification of such products at any time without notice.

---

# Contents

<b>Welcome</b> .....	<b>ix</b>
Important Information .....	ix
About this Book .....	ix
Assumptions .....	x
Documentation Conventions .....	xi
Using the Mouse .....	xi
Selecting from Menus or Hierarchies .....	xi
What You Need to Get Started .....	xi
<b>Chapter 1 DeltaV System Overview</b> .....	<b>1-1</b>
Hardware .....	1-1
DeltaV System Concepts .....	1-2
Terminology .....	1-3
DeltaV Software Applications .....	1-6
Engineering Tools .....	1-7
Auto-Update Service .....	1-7
Configuration Assistant .....	1-7
Continuous Historian Administration .....	1-8
Control Studio .....	1-8
Database Administrator .....	1-9
DeltaV Explorer .....	1-9
DeltaV Operate Configure .....	1-10
FlexLock .....	1-10
Recipe Studio .....	1-11
System Alarm Management .....	1-11
System Preferences .....	1-11
User Manager .....	1-11
Advanced Control .....	1-12
DeltaV Inspect .....	1-12
DeltaV Neural .....	1-12
DeltaV Predict .....	1-13
DeltaV PredictPro .....	1-13
DeltaV Simulate Suite .....	1-14
DeltaV Tune .....	1-14
Operator Tools .....	1-14
Batch History View .....	1-14
Batch Operator Interface .....	1-15
DeltaV Login .....	1-15

DeltaV Operate Run . . . . .	1-15
Diagnostics . . . . .	1-15
MPC Operate . . . . .	1-16
Process History View . . . . .	1-16
Installation Tools . . . . .	1-17
Other Applications . . . . .	1-17
OPC Server . . . . .	1-17
DeltaV Excel Add-In . . . . .	1-17
Continuous Historian Excel Add-In . . . . .	1-18
OPC Mirror . . . . .	1-18
Introducing DeltaV . . . . .	1-18
Where to Find More Information . . . . .	1-18
DeltaV Online Help . . . . .	1-18
DeltaV Books Online . . . . .	1-20
World Wide Web Page . . . . .	1-21
The DeltaV Release News . . . . .	1-21
Paper Manuals . . . . .	1-21
Technical Service . . . . .	1-22
Windows Online Help . . . . .	1-22

**Chapter 2 Overview of the Tutorials . . . . . 2-1**

A Look Ahead . . . . .	2-1
Scenario for the Tank Process Example . . . . .	2-2
Control Modules . . . . .	2-2
Sequential Function Chart . . . . .	2-3
Operator Pictures . . . . .	2-4
Let's Get Started! . . . . .	2-4

**Chapter 3 Learning About the DeltaV Explorer . . . . . 3-1**

Opening the DeltaV Explorer . . . . .	3-2
Views . . . . .	3-3
Navigating the DeltaV Explorer . . . . .	3-3
Opening and Closing Levels . . . . .	3-3
Documentation Convention for DeltaV Explorer Navigation . . . . .	3-3
Exploring the Library Templates . . . . .	3-4
Function Block Templates . . . . .	3-4
Module Templates . . . . .	3-6
Context Menus . . . . .	3-7
System Time . . . . .	3-7
On Your Own . . . . .	3-8

<b>Chapter 4 Creating and Downloading the Control Strategy</b>	<b>4-1</b>
Exercise 1: Creating and Naming Plant Areas	4-2
Exercise 2: Using the DeltaV Explorer to Copy a Module (MTR-101)	4-4
Introducing Control Studio	4-5
Parameter Filtering	4-7
Exercise 3: Creating a Control Module (XV-101) in Control Studio Using a Library Template	4-8
Opening Control Studio	4-8
Modifying the XV-101 Control Module	4-11
Exercise 4: Finishing Steps for All Control Modules	4-15
Identifying the Operator Pictures Associated with a Module	4-15
Assigning the Module to a Controller Node	4-16
Saving the Module	4-17
Verifying the Module Configuration	4-18
Exercise 5: Creating a New Module (LI-101) from Scratch	4-20
Finishing the LI-101 Module	4-27
Exercise 6: Creating a PID Control Loop (FIC-101)	4-27
Looking at the Module in Control Studio	4-29
Modifying Alarms for the PID Loop Module	4-30
Finishing the FIC-101 Module	4-31
Exercise 7: Modifying the Motor Module (MTR-101)	4-32
Removing the Excess Condition Blocks	4-34
Specifying Conditions with the Expression Editor	4-36
Parameter Tagnames	4-38
Interlock Conditions	4-39
Finishing the MTR-101 Module	4-42
Exercise 8: Creating a Sequential Function Chart	4-42
The Sequence for the Tank Process	4-43
Creating the SFC Module	4-45
Finishing the SFC Module	4-52
Exercise 9: Downloading the Modules	4-53
A Look Ahead	4-55
<b>Chapter 5 Creating Operator Pictures</b>	<b>5-1</b>
The DeltaV Operating Environment	5-1
Developing a Picture Hierarchy	5-3
The Overview Picture and the UserSettings File	5-4
Navigating to Other Pictures	5-5
Switching Between Configure and Run Modes	5-6
Getting Started with DeltaV Operate (Configure Mode)	5-7
Toolbars and the Toolbox	5-10
Color	5-12

---

Line Styles and Fill Styles . . . . .	5-13
Links, Dynamic Properties, and Parameter References . . . . .	5-14
Creating Datalinks . . . . .	5-16
Switching to DeltaV Operate in Run Mode . . . . .	5-24
Dynamos . . . . .	5-24
Creating a Pump Using a Dynamo. . . . .	5-26
Creating a Tank Using a Dynamo . . . . .	5-27
Finishing the Process Picture . . . . .	5-28
Trend Links . . . . .	5-30
Setting Previous and Next Pictures . . . . .	5-32
Creating a Pushbutton to Start the SFC. . . . .	5-33
<b>Chapter 6 Using DeltaV Operate in Run Mode . . . . .</b>	<b>6-1</b>
Main History . . . . .	6-3
The Standard Buttons in the Main Window . . . . .	6-5
Faceplate and Detail Pictures . . . . .	6-5
Entering Data in User-Changeable Fields. . . . .	6-8
Acknowledging Alarms. . . . .	6-8
On Your Own. . . . .	6-9
<b>Chapter 7 Collecting and Displaying Data . . . . .</b>	<b>7-1</b>
Continuous Process Data Collection. . . . .	7-1
History Collection . . . . .	7-1
Continuous Historian and Alarms and Events Subsystems . . . . .	7-2
Assign TANK-101 to the History Subsystems . . . . .	7-2
Enable History Collection . . . . .	7-4
Download the Workstation . . . . .	7-6
View the Data. . . . .	7-7
Excel Add-In. . . . .	7-10
Setting up the Excel Add-In. . . . .	7-10
Using the Excel Add-In . . . . .	7-11
Continuous Historian Excel Add-In . . . . .	7-13
<b>Chapter 8 Configuring the Network, Loading and Assigning Licenses, and Setting Up User Accounts. . . . .</b>	<b>8-1</b>
Configuring DeltaV Workstations . . . . .	8-2
Accessing DeltaV Workstation Configuration . . . . .	8-3
DeltaV Software Licenses. . . . .	8-4
System Software . . . . .	8-4
Controller Software . . . . .	8-4
Workstation Software . . . . .	8-5

---

Redundant Controllers . . . . .	8-6
Loading and Assigning Licenses . . . . .	8-6
Loading Licenses . . . . .	8-6
Assigning Licenses to Nodes . . . . .	8-8
Downloading the ProfessionalPLUS Workstation. . . . .	8-11
Configuring Other Workstations . . . . .	8-12
Configuring the Controller Node . . . . .	8-17
Configuring I/O Channels . . . . .	8-21
Downloading the Controller Configuration . . . . .	8-27
Setting Up Your First User Account . . . . .	8-28
Adding a User . . . . .	8-30
The Groups and Keys Tabs . . . . .	8-31
Downloading the Workstation . . . . .	8-32

<b>Glossary . . . . .</b>	<b>Glossary-1</b>
---------------------------	-------------------

<b>Index . . . . .</b>	<b>Index-1</b>
------------------------	----------------





---

# Welcome

Welcome to the Emerson Process Management DeltaV™ digital automation system. The DeltaV system offers powerful, easy-to-use software for designing and operating a process control application. The system uses many standard Windows features to provide a familiar user interface.

This revision of *Getting Started with Your DeltaV Digital Automation System* supports DeltaV Version 8.3 software. For earlier versions of the DeltaV software, retain the manual applicable to that version.

## Important Information

This book is intended for users of a new system, not one that is already controlling a process. We recommend that you do not perform any tutorial procedures that involve installation of configuration information into an operational system without fully considering the impact of these changes.

The first user must log into Windows using the Administrator account. The default password for this account is `deltav` (lowercase). In a workgroup environment, the first thing that person must do is to change the account password and then change the passwords on the administrator accounts on the other workstations to match this password. In a domain environment, the first user must change the password on the primary domain controller, and then, for security purposes, change the password on the local administrator account to a different password. Then, that user should configure the ProfessionalPLUS Workstation, load and assign licenses, and download that workstation's configuration.

It is assumed that Windows software and the DeltaV software are installed on your computer and that you are using a new DeltaV system. For late breaking information and upgrade procedures, click [Start | All Programs | DeltaV | Help | Release News](#).

## About this Book

This introduction to the DeltaV software applications will help you get a control system up and running quickly. It is divided into eight chapters and a Glossary.

- Chapter 1, *DeltaV System Overview*, introduces basic concepts and terminology and gives an overview of the system's applications.
- Chapter 2, *Overview of the Tutorials*, describes the tutorial exercises in Chapters 3 through 8. The tutorials guide you through the development of a control

---

strategy and operator pictures for a simple process example. The scenario for the process example is described in detail.

- Chapter 3, *Learning About the DeltaV Explorer*, shows you how to open the DeltaV Explorer and use the navigation features.
- Chapter 4, *Creating and Downloading the Control Strategy*, steps you through the creation of four modules for controlling a tank discharge and a sequential function chart that defines the process startup sequence.
- Chapter 5, *Creating Operator Pictures*, introduces the basic tools for using DeltaV Operate in configure mode and shows you how to create a set of operator pictures complete with colorful graphics, faceplate and detail pictures, pushbuttons, and a trend chart.
- Chapter 6, *Using DeltaV Operate in Run Mode*, shows the operator pictures from the operator viewpoint and explains how to navigate the pictures, change operating parameters, acknowledge alarms, and perform other operator tasks.
- Chapter 7, *Collecting and Displaying Data*, shows how you can gather and display system and process data using DeltaV tools and the Excel Add-In.
- Chapter 8, *Configuring the Network, Loading and Assigning Licenses, and Setting Up User Accounts*, steps you through the procedures for configuring workstations, controllers, and I/O, and assigning licenses to workstations and controllers.
- The Glossary is limited to the terms introduced in this book. A more complete glossary can be found in the DeltaV Books Online.

## Assumptions

It is assumed that you are a control engineer getting ready to configure a DeltaV application. You are familiar with control theory and are somewhat familiar with the implementation of control systems.

It is also assumed that you are familiar with the basics of using Microsoft Windows. Some tips on using Windows are included in this book. However, you may want to access the Microsoft online help for additional information.

---

# Documentation Conventions

The following sections contain information on conventions used in this document for using the mouse and selecting from menus.

## Using the Mouse

Instructions for using the mouse follow the conventions below.

- Click means click the left mouse button (unless you are specifically told to click the right mouse button).
- Double-click means rapidly click the left button twice.
- Drag-and-drop means point to the object, hold down the left mouse button, point to a new position, and release the mouse button.

In most DeltaV applications, special context menus (also called shortcut menus) are available when you point to a particular area or object and click the *right* mouse button. The menu displayed will vary, depending on the application and where you are pointing when you click the right mouse button.

## Selecting from Menus or Hierarchies

A vertical bar is used to indicate that you should select items in sequence. For example, to open the DeltaV Explorer application, the instruction would be to click Start | All Programs | DeltaV | Engineering | DeltaV Explorer. This means click the Start button, select All Programs, select DeltaV, select Engineering, and click on DeltaV Explorer.

## What You Need to Get Started

If you are the first user of a new DeltaV system, the minimum you need to get started using the DeltaV system is a ProfessionalPLUS workstation with pre-installed DeltaV software.

When you turn on your workstation for the first time, you will see a screen telling you that you need to configure your workstation.

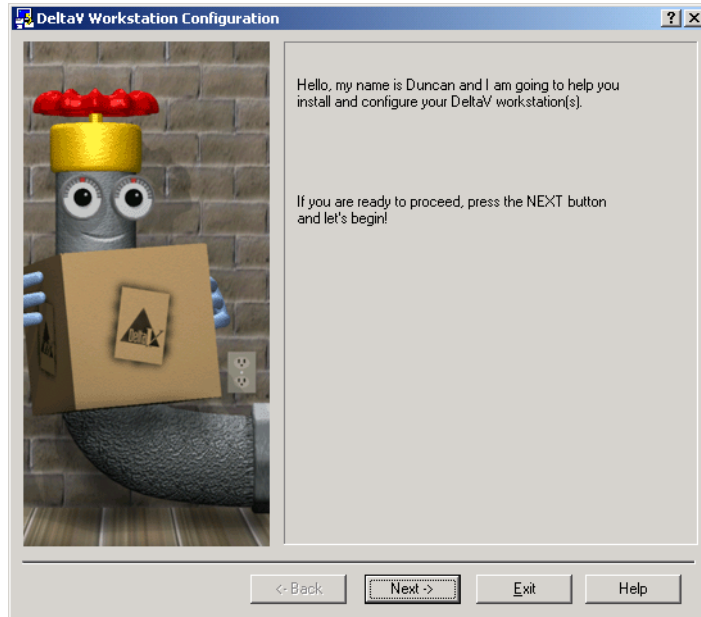

To be able to use the DeltaV system, the startup steps you need to perform are:

1. Configure the workstation.
2. Load and assign licenses.
3. Download the workstation setup data.

These basic steps are described in Chapter 8. After the three steps listed above are done, you can go through the other tutorials in this book to get acquainted with the system.

# Chapter 1 DeltaV System Overview

This chapter gives an overview of the DeltaV digital automation system. It takes a brief look at the hardware, describes the basic concepts and terminology, introduces the major software components, and ends with a summary of the ways you can find out more about the DeltaV system from the Help and Books Online.

## Hardware

The manual, *Installing Your DeltaV Digital Automation System*, also available as an online book, describes the DeltaV system hardware and provides instructions for installing and powering up the system.

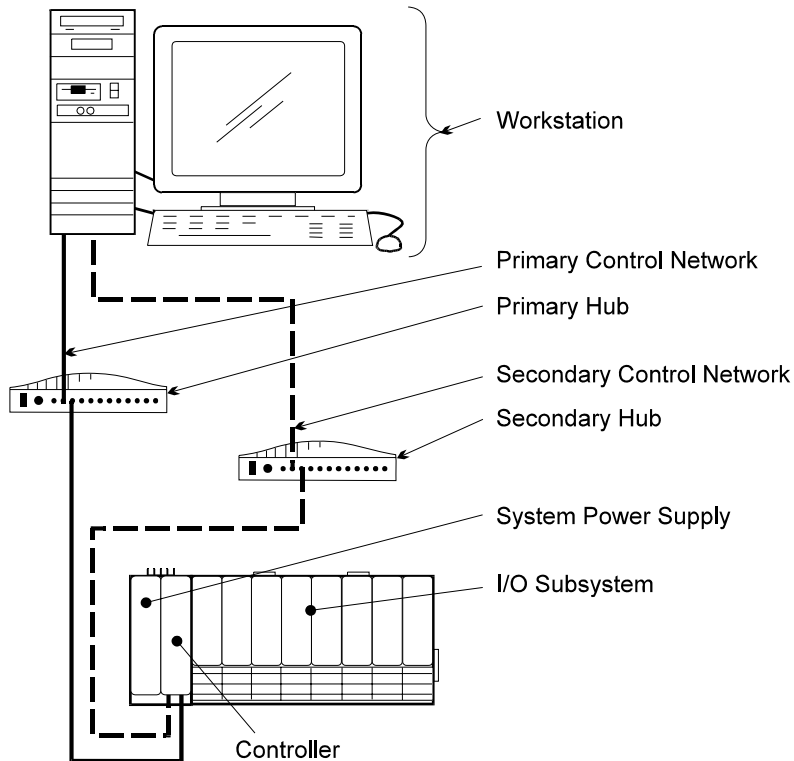

---

The system hardware consists of the following:

- One or more DeltaV workstations
- A control network (optionally redundant) for communication between system nodes
- Power supplies
- One or more DeltaV controllers (optionally redundant) that perform local control and manage data and communications between the I/O subsystem and the control network
- At least one I/O subsystem per controller that processes information from field devices
- System Identifier

The System Identifier, shipped in the License Pack, is a connector that plugs into the parallel printer port or Universal Serial Bus (USB) on the ProfessionalPLUS workstation. It gives each DeltaV system a unique identification that allows you to download changes to the system. Install the System Identifier on the ProfessionalPLUS workstation before you power up your system.

## DeltaV System Concepts

The DeltaV system helps users create process control systems that are easy to set up, easy to operate, consistent, and secure. To accomplish these goals, the DeltaV system uses the following:

- Plug-and-play technology for hardware configuration
- A library of reusable control modules to simplify the initial configuration effort
- Techniques like drag-and-drop to simplify system configuration and modification
- Consistent graphical interface similar to that of the Microsoft Windows operating environment
- Integrated, context-sensitive help and online documentation
- Hardware and software approaches to ensure system security and integrity
- A Configuration Assistant that steps you through the configuration process, configuring the system while teaching you the fundamentals

---

## Terminology

Control strategies in the DeltaV system are configured in **modules**. A module, which is the smallest logical control entity in the system, contains algorithms, conditions, alarms, displays, historical information, and other characteristics that define the process equipment. **Algorithms** are the logical steps that define how the module behaves. The DeltaV system provides control, equipment, and unit modules.

Generally, a **control module** contains one uniquely tagged control entity, such as a control loop or motor, with its associated logic. Defining a module around a single field device and its related control logic makes it easy to create, download, operate, debug, and take a single module out of service without affecting other modules.

**Equipment modules** coordinate the operation of control modules and other equipment modules that work together to control related equipment. The algorithm for the containing equipment module manages the operation of the contained modules.

**Unit modules** can be used in non-batch applications to group control modules and equipment modules for alarm management purposes. For example, alarms for a specific unit, such as a boiler, can be combined. All control and equipment modules associated with the unit will be contained within the unit module.

**Function blocks** are building blocks for creating the continuous and discrete algorithms that perform the control or monitoring for the process. The DeltaV Library contains function block templates for analog control (bias/gain, lead/lag, PID, etc.), Logical, I/O (analog and discrete input/output), and other basic functions. Each function block contains parameters that can be modified to customize the algorithm. Algorithms range from simple input conversions to complex control strategies. Function blocks can be combined into composite function blocks to build complex algorithms.

In addition to Function Block algorithms, the DeltaV system supports **Sequential Function Charts** (SFCs) as well as **Command-driven** and **State-driven** algorithms for control tasks requiring sequencing strategies.

**Parameters** are the user-defined data used within a module's algorithm to perform its calculations and logic. Parameters can be described by the type of information they provide, such as input or output. Tables listing the parameters and their properties are included in the Books Online information.

The DeltaV system includes a **library** of pre-engineered module templates with basic characteristics. You can customize these library modules or create your own modules from scratch. Your customized modules can be added to the library, making them available for reuse in the development of your control strategy.

---

Modules that work closely together to perform a specific process control function are typically grouped in an **area**. An area is a logical division of a plant. Areas typically represent plant locations or main processing functions. The configuration engineer determines how to logically divide the plant into areas.

**Nodes** are physical pieces of equipment on the control network, such as a controller or a workstation. You control your process by downloading modules in the controller nodes. The configuration tells the node how to act and what information to receive or save from the process.

**Device Tags** represent the instruments, valves, and other field devices. A **Device Signal Tag** consists of a specific signal from a device.

**Alarms** alert the operator that an event has occurred. (Alarms are assigned to modules.) Typically, you want the operator to perform some action and respond to the alarm. Alarms can be both visible and audible.

The **database** contains configuration information and lets you make off-line changes without affecting the process. Online control algorithm monitoring and modification are also available.

Following is a diagram showing the DeltaV system's hierarchical structure.



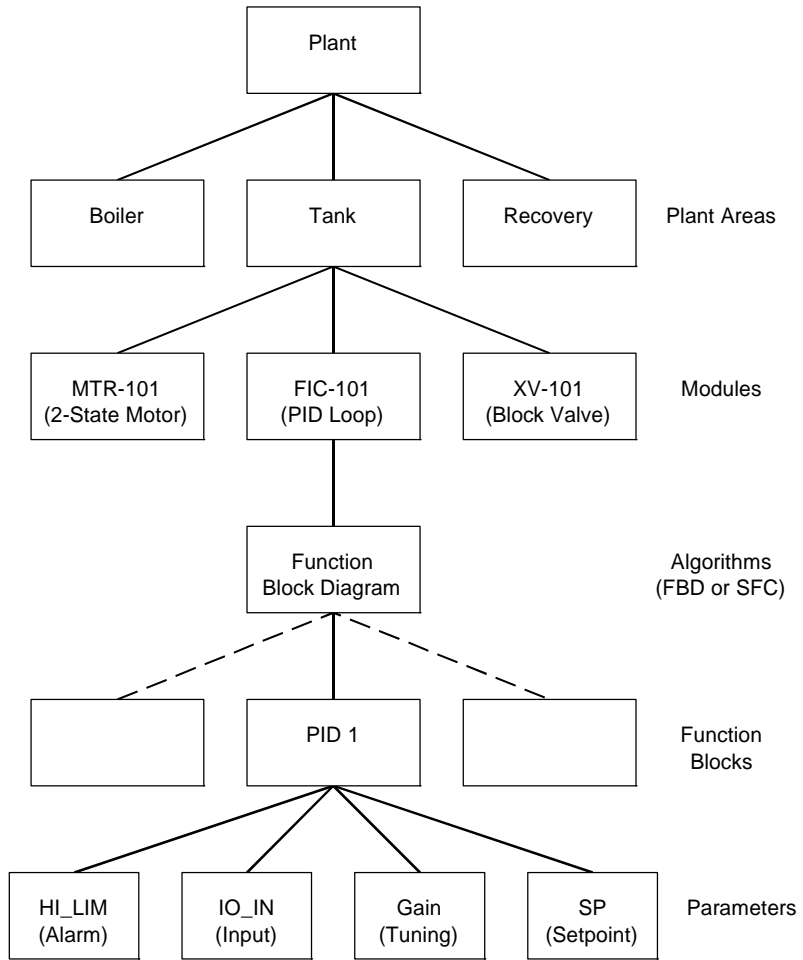

# DeltaV Software Applications

DeltaV system software includes a variety of applications to help you configure, operate, document, and optimize your process. The primary applications are categorized as Engineering Tools and Operator Tools. Additional tools are available for Advanced Control, Installation, and Online Help.

There are several ways to start an application. One is to click Start (in the lower left corner of your screen), point to All Programs, point to DeltaV, point to the category, and click the name of the application. For instance, to start the DeltaV Explorer, the Start menu selection would look like the following:

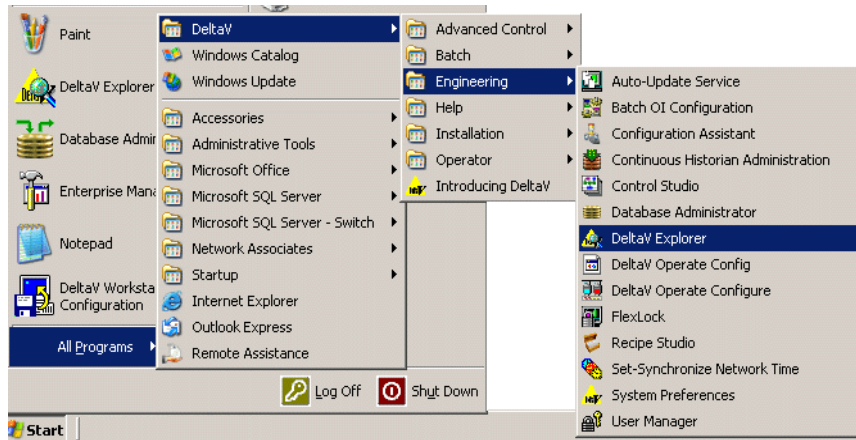

In this book, the instruction for starting the DeltaV Explorer is expressed as “Click Start | All Programs | DeltaV | Engineering | DeltaV Explorer.”

Many applications allow quick access to other DeltaV applications through buttons on their toolbars and through an Applications menu. The following example shows the Applications menu and some of the toolbar buttons in the DeltaV Explorer.

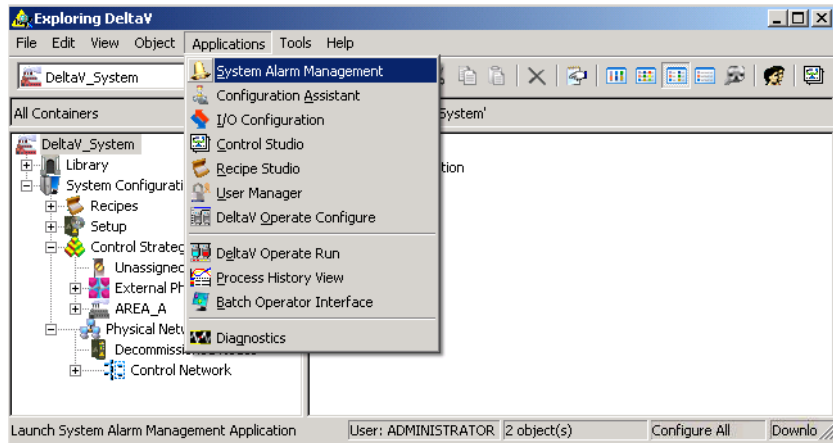

In the paragraphs that follow, the application's toolbar button or Start menu icon is shown next to the description.

## Engineering Tools

The main engineering tools are Configuration Assistant, DeltaV Explorer, Control Studio, and, if you have a license for the batch applications, Recipe Studio. Others include User Manager, Database Administrator, FlexLock, and System Preferences.

## Auto-Update Service



Use the Auto-Update Service to set which files are automatically transferred from the ProfessionalPLUS workstation to all other workstations after any node is downloaded.

## Configuration Assistant



If you are a first time user, Configuration Assistant is a great tool to learn the basics of the DeltaV system. Once you become familiar with the configuration methodology, you will most likely use the DeltaV Explorer.

## Continuous Historian Administration



The Continuous Historian Administration application provides tools to manage continuous history data. This application must be run on the same workstation as the Continuous Historian.

## Control Studio



Control Studio is used to design and modify the individual modules and templates that make up your control strategy. With this application you can graphically build a control module by dragging items from a palette to the module diagram. You then “wire the items together” to create an algorithm for the module.

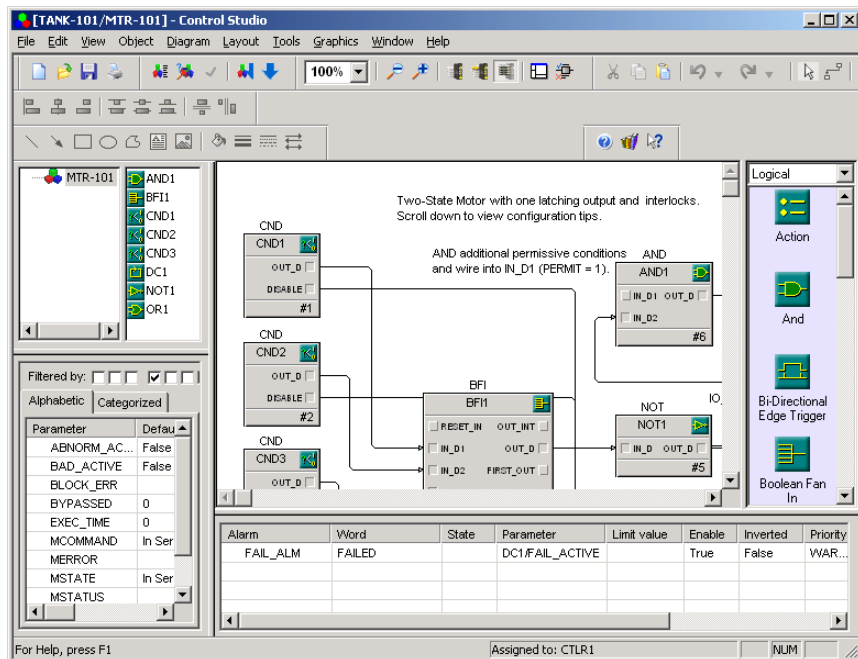

Control Studio supports a range of industry concepts including Function Blocks (for continuous control) and Sequential Function Charts (for sequential control). You can mix elements of these control languages within a single control module.

The graphical languages are based on the IEC 61131-3 standard, and function blocks were developed using the FOUNDATION™ Fieldbus standard.

---

## Database Administrator



The Database Administrator tools let users with the necessary administrator privileges perform database maintenance tasks such as creating, deleting, copying, and backing up databases.

## DeltaV Explorer



DeltaV Explorer, similar in appearance to the Windows Explorer, is an application that lets you define system components (such as areas, nodes, modules, and alarms) and view the overall structure and layout of your system.

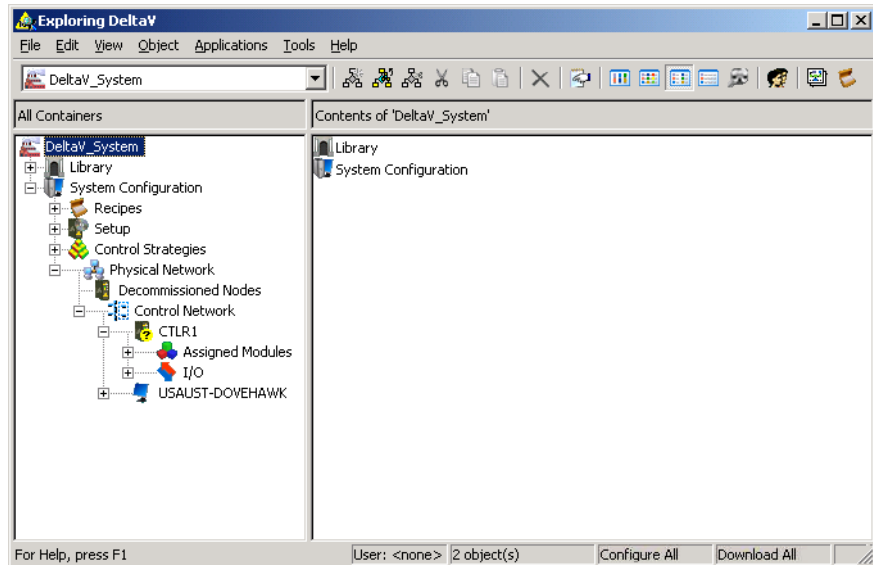

You can do many things with this application, including:

- Create, copy, or move modules
- Configure system hardware
- Define types and priorities of alarms
- Launch Control Studio and other applications

---

## DeltaV Operate Configure



The DeltaV Operate application functions in two modes. In configure mode, it is used to build high resolution, real-time process graphics. In run mode, control system operators use these graphics in the daily monitoring and maintenance of the process.

In configure mode, you can incorporate scanned plant images, text, graphics, animation, and sound into the process graphics. A predefined desktop template simplifies the typical effort of designing operator displays. This application uses pull-down menus, toolbox buttons, drag-and-drop features, and easy-to-use drawing tools. It also provides sets of dynamos (reusable graphics, many of which have animation capabilities) for use in designing operator graphics.

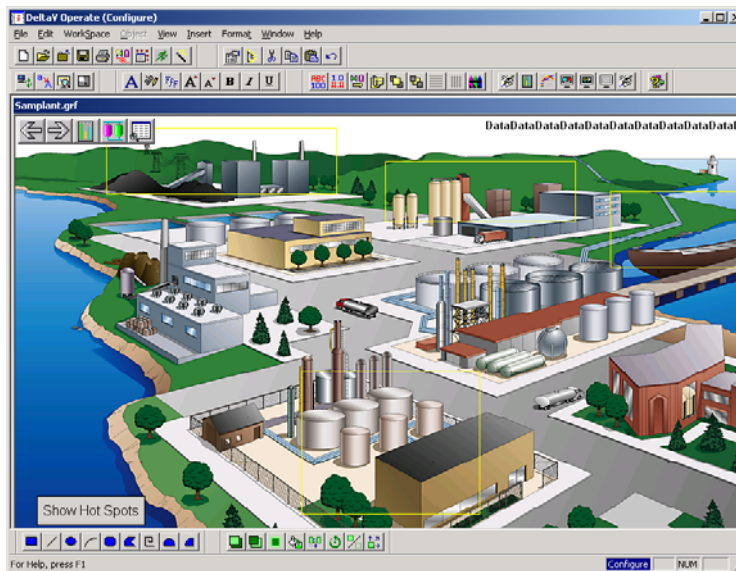

## FlexLock



The DeltaV FlexLock application creates dual desktops (Windows desktop and the DeltaV desktop) on a single workstation to provide both a secure operating environment and a wide open engineering environment. Access to a desktop is determined by the current user's privileges.

---

## Recipe Studio



Recipe Studio is used to create and modify recipes. A recipe is a set of information that uniquely identifies the ingredients, the quantities of ingredients, and the production equipment required to manufacture a product. A recipe can be as simple or as complex as you would like to make it. DeltaV Recipe Studio is modeled after Control Studio.

## System Alarm Management



The System Alarm Management application lets you view and work with alarms within selected areas, units, modules, and Logic Solvers. It provides a way to efficiently view multiple alarms, enable and disable multiple alarms, and set limits and priorities on multiple alarms.

## System Preferences



System Preferences allows you to tailor the Engineering Tools to hide any functions that you do not require. Enabling or disabling a function causes the DeltaV applications to reveal or conceal the applicable menus and choices without adding or removing any application software.

## User Manager



User Manager lets you specify access levels for groups and individuals. You define the roles users can have (administrator, operator, engineer, and so on) and the typical privileges and span of control required for each role. Then, when you create individual user accounts, you specify the role or roles a user will have.

To be able to create or edit control modules, a user needs to have configure privileges. Similarly, to download configuration changes, a user needs download privileges.

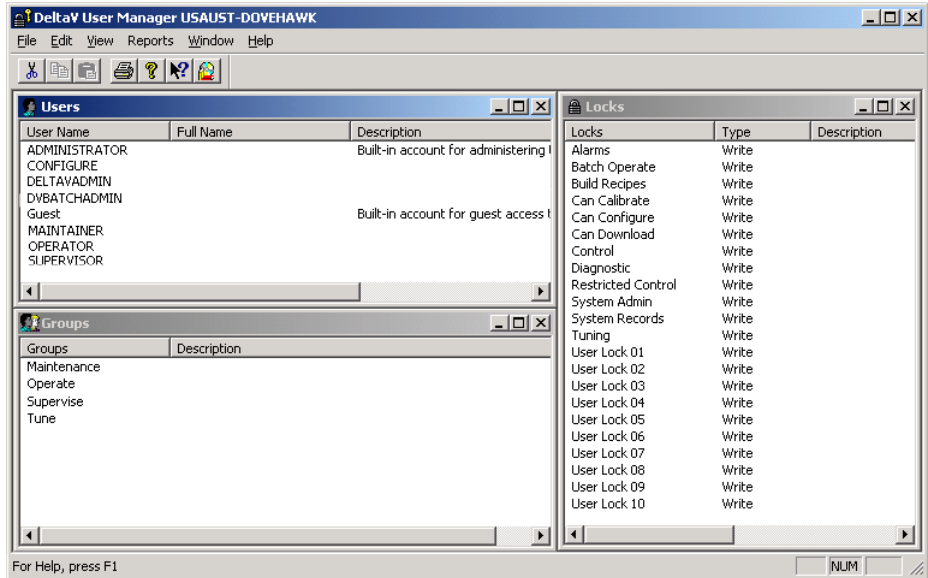

## Advanced Control

The advanced control applications are DeltaV Inspect, DeltaV Neural, DeltaV Predict, DeltaV PredictPro, DeltaV SimulatePro (in DeltaV Simulate Suite), and DeltaV Tune

### DeltaV Inspect



DeltaV Inspect provides advanced process monitoring to instantly identify underperforming loops. It calculates a Variability Index for select Control and I/O blocks. For all blocks, the input status and mode are monitored. For Control blocks, block performance and detection of limited control are also monitored. In addition, FF and Hart devices that support hardware alarms are displayed with the current alarm status.

### DeltaV Neural



DeltaV Neural is a collection of tools used to implement neural networks in DeltaV environments. With DeltaV Neural you can create virtual sensors to monitor and predict process parameters that are otherwise expensive, difficult, or impossible



---

to measure directly. Neural networks are sometimes referred to as intelligent or software sensors. DeltaV Neural consists of:

- Neural Network (NN) function block
- Lab Entry (LE) function block
- Neural application
- NN and Lab Entry dynamos
- NN and Lab Entry faceplates
- NN and Lab Entry detail displays

## DeltaV Predict



DeltaV Predict implements model predictive control for small and medium-sized multivariable processes in DeltaV environments. DeltaV Predict allows you to control interactive processes within measurable operating constraints while automatically accounting for process interaction and measurable disturbances. DeltaV Predict consists of:

- Model Predictive Control (MPC) function block
- MPC Simulation function block
- Dynamos
- MPC Operate application

## DeltaV PredictPro



DeltaV PredictPro implements model predictive control of large multivariable processes in DeltaV environments. It allows you to define as many as five control objectives for interactive processes within measurable operating constraints while automatically accounting for process interaction and measurable disturbances. With PredictPro you can easily address a wide variety of multivariable processes as large as 40x80 that can benefit from Model Predictive Control (MPC) technology. DeltaV PredictPro consists of:

- Model Predictive Control Professional (MPCPro) function block
- MPC SimulatePro application
- Dynamos
- MPCPro Operate application

---

## DeltaV Simulate Suite



The DeltaV Simulate Suite consists of the following products:

- DeltaV Simulate Standalone
- DeltaV Simulate Multi-Node
- DeltaV SimulatePro

DeltaV Simulate Standalone and Multi-Node enable you to install all DeltaV software on standalone or networked PCs for off-line development and operator training. Using DeltaV Simulate, you can configure all of the features that the DeltaV system supports (for example, continuous control, batch control, advanced control and its associated workstation displays, alarms, and historian data collection) without DeltaV hardware. DeltaV SimulatePro enables more memory and a user interface for coordinating module execution, permitting interaction with any process simulation package that uses an OPC interface running on the PC.

## DeltaV Tune



DeltaV Tune consists of one window from which you can tune PID and Fuzzy Logic Control (FLC) function blocks. DeltaV Tune identifies process dynamics and applies tuning rules to calculate the PID tuning (gain, reset, and rate) or FLC scaling factors. The newly calculated factors are displayed at the DeltaV workstation, and the user can accept the new values, calculate different tuning values, or continue operating with the present tuning values.

## Operator Tools

The operator tools are used for the day-to-day operation of the process control system. The primary operator tools are DeltaV Operate Run, Process History View, Diagnostics, and, if you purchased a license for the batch applications, Batch Operator Interface. The DeltaV Login application is used to log in and out of the DeltaV system and to change the DeltaV system password.

## Batch History View



Batch History View retrieves batch-specific data from the Batch Historian database and allows you to view the data in several different formats. It is also possible

---

to add comments and have them saved as part of a batch's history in the Batch Historian database.

## Batch Operator Interface



The DeltaV Batch Operator Interface is the graphical interface used by the operator to monitor and control all automated batch operations. The Batch Operator Interface provides the operator many different views into the batch production process. Operators can easily switch between views by clicking on toolbar buttons.

## DeltaV Login



The DeltaV Login application shows the current user and lets operators log on and off the DeltaV system and change their DeltaV system password.

## DeltaV Operate Run



The DeltaV Operate application functions in two modes. In configure mode, it is used to build high resolution, real-time process graphics. In run mode, control system operators use these graphics in the daily monitoring and maintenance of the process.

In run mode, operators interact with the process control system through the DeltaV Operate application. High-resolution graphics allow extensive detail and flexibility in the way information is displayed. A standard operating desktop designed specifically for DeltaV process control systems provides an easy-to-use, highly reliable operator environment.

Alarm presentation and management focus the operator's attention on the most important alarms. Toolbar buttons enable single-click access to common operator functions.

## Diagnostics



The Diagnostics application provides you with information on the status and integrity of the system devices. You can view the diagnostics information any time after you have placed the system devices on the control network and downloaded your workstations.

## MPC Operate



The MPC Operate application provides an overview to the MPC (Model Predictive Control) block operation. It contains faceplates to view and manipulate parameter values associated with the block's inputs and outputs and a trend chart to view historical, current, and predicted values for Controlled and Constrained inputs.

## Process History View



DeltaV Process History View displays real-time and historical data from the Continuous Historian as well as from the Event Chronicle. Module and node parameters are plotted on a graph and events are displayed in a tabular (grid) format.

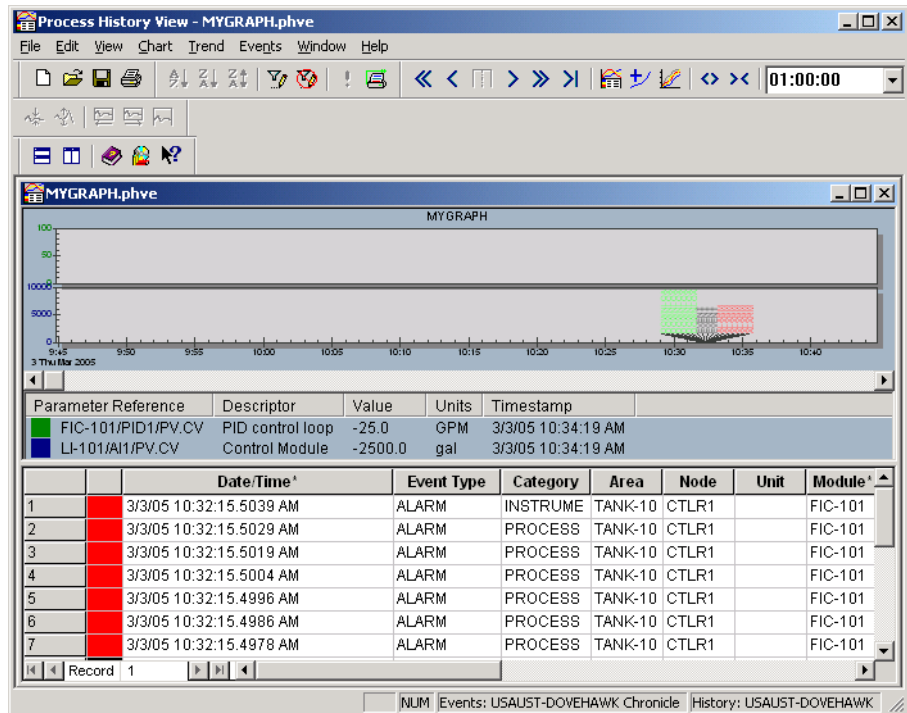

You use the application to examine how your process functioned at any point in time. You must download the setup data for the workstation that has an enabled Event Chronicle and Continuous Historian in order for the Process History View to view the Continuous Historian and Event Chronicle data.

---

## Installation Tools

The main tools in this category are listed below.

- Controller Upgrade Utility is used to update the firmware in the controller when new software is released by Emerson Process Management. It is also used to upgrade I/O modules, remote I/O nodes, DeltaV SIS components, H1 fieldbus devices, and RS3 and PROVOX I/O interfaces.
- DeltaV Operator System Configuration Utility is used to configure aspects of the Operator System, such as file paths for picture files and trend data.
- DeltaV Workstation Configuration is used to set up the ProfessionalPLUS Workstation and other workstations. Workstation Configuration is described in detail in Chapter 8, under Configuring DeltaV Workstations.
- DeltaV Guardian Application is used by Emerson SureService support to enable and disable monitoring of the DeltaV system when the system is enrolled in the Guardian Support Plan.
- The SureService Registration utility is used to complete and submit your DeltaV system registration form.

## Other Applications

The following subsections contain information on other applications related to the DeltaV system.

### OPC Server

The DeltaV OPC Server works in the background and does not show up on the Start menu. It makes data such as process data, alarms, diagnostics, and engineering information easy to access and available for import into desktop applications such as Microsoft Excel. The Real-Time Data Server also supports comprehensive analysis tools such as historian packages, manufacturing systems, and laboratory management systems.

### DeltaV Excel Add-In

The DeltaV system provides an interface to Microsoft Excel to allow access to real-time data from your DeltaV process system. You can then use Excel to generate reports, create charts, and perform further analysis on the data.

---

## Continuous Historian Excel Add-In

The Continuous Historian Excel Add-In provides functions and dialogs to aid creation of detailed Excel workbooks containing historical data read from or interpolated from the DeltaV Continuous Historian database.

## OPC Mirror

The OPC (OLE for Process Control) Mirror connects OPC servers on multiple control systems and enables bi-directional data traffic from one system to another. This linkage can be between DeltaV OPC servers, DeltaV and PROVOX servers, or several other OPC server combinations.

## Introducing DeltaV

Introducing DeltaV lets you choose between the Configuration Assistant for a guided tour of the DeltaV system or the DeltaV Explorer so you can easily get started using the DeltaV software.

## Where to Find More Information

The DeltaV system provides online help to assist you when you need a description of a field or step-by-step instructions for how to do something. It also has a set of online reference books that discuss basic concepts and provide background information about the major applications. Other sources of information include a World Wide Web page, paper manuals, and a number of technical service support options.

## DeltaV Online Help



The DeltaV system provides online assistance in several forms. The Help system can be accessed in DeltaV applications by pressing the F1 key, by clicking the Help Topics button on the toolbar, or by selecting Help | Help Topics on the menu bar.

The Help Topics dialog has three tabs: Contents (for an expandable list of topics), Index (for keyword search), and Find (for full-text search). If you need assistance on using Help, one of the topics in every Help application is “Using Help.” Below are examples of the Contents and Index tabs from the DeltaV Explorer Help.

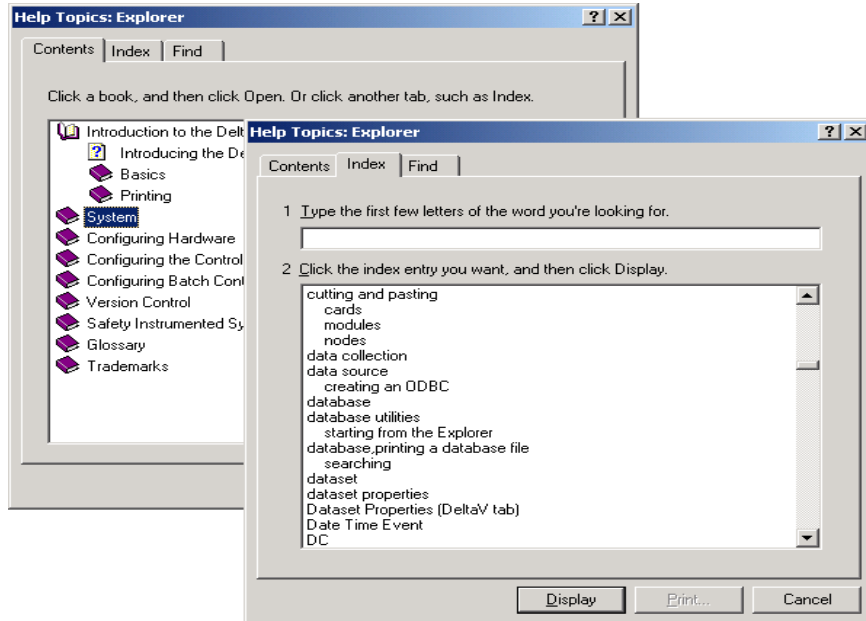

 Context-sensitive help is available in most applications by clicking the Help (question mark) button. Context-sensitive help gives you more information about what you see on your screen. Simply click the button and then click the field or area for which you want a description.

 The “What’s This?” help button is also available in several applications to describe commands and objects. In some applications, you can point to an object, click the right mouse button, and select “What’s This?” from the context menu to get the same information.

## DeltaV Books Online



The DeltaV Books Online is a set of online reference books on installing, configuring, operating, and troubleshooting your DeltaV system. This Getting Started book is also available online.

There are three main ways to access Books Online:

- Click the Books Online button on a DeltaV application toolbar.
- From the Help menu in a DeltaV application, select Books Online.
- From your Windows desktop, click Start | All Programs | DeltaV | Help | Books Online.

To open a book, simply click the plus sign (+) next to the title in the Table of Contents.

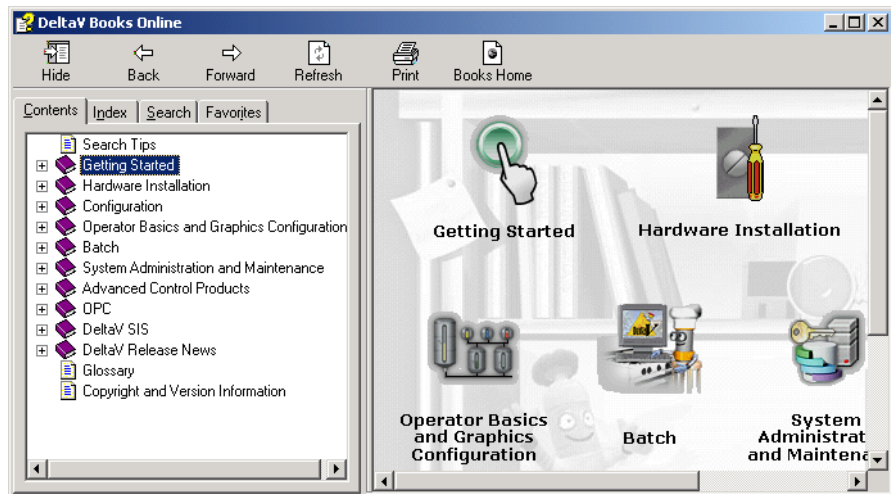



Books Online provides an easy-to-use Table of Contents that lets you select a topic from the contents on the left and view the topic in a window on the right. For example, the figure below shows the contents under Function Blocks - General Information (in the Configuration book). To move through a book, continue to click the plus signs to expand the Table of Contents.

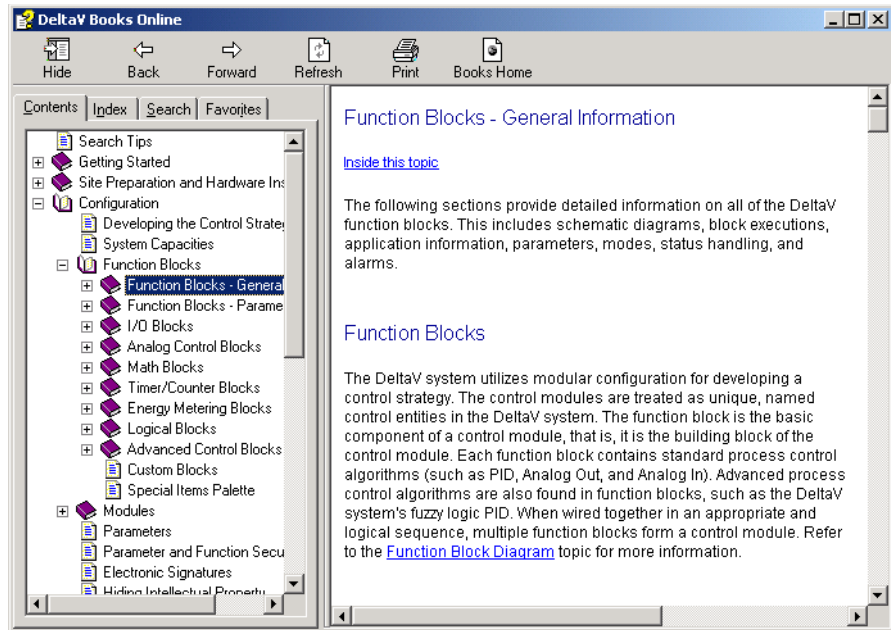

## World Wide Web Page

Current information is available on the DeltaV World Wide Web page. The address is <http://www.easyDeltaV.com>.

## The DeltaV Release News

The DeltaV Release News contains late breaking news, recommendations, and troubleshooting hints. We strongly suggest that you browse through this file, which can be accessed by clicking Start | All Programs | DeltaV | Help | Release News.

## Paper Manuals

Most DeltaV product information is in Books Online. You can print single pages, chapters, or whole books. You can also order a paper copy of most manuals from Emerson Process Management.

---

## Technical Service

There are several options available for technical service, including help desk support, remote diagnosis, 24-hour emergency support, and software update service. The technical support options are described in the Maintenance manual in the Books Online.

The Technical Support telephone numbers are listed in the Help System under Frequently Asked Questions, as well as in the Maintenance manual in the Books Online.

## Windows Online Help

If you are unfamiliar with Microsoft Windows, you can access the Windows online Help by clicking Start | Help and Support.

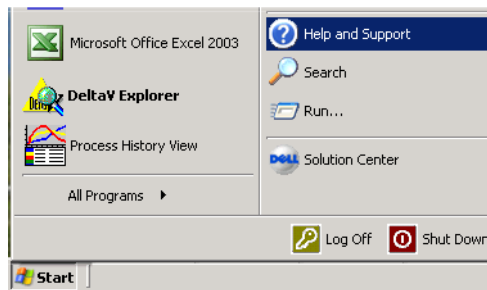

---

## Chapter 2 Overview of the Tutorials

The tutorials in this book will show you how to get a process system up and running quickly. You will learn the basic concepts needed to configure workstation and controller nodes, define I/O, develop a control strategy, and create operator pictures. You will also see the process system from the operator's point of view.

Hardware configuration is typically a one-time operation—and may already have been done for your system. Therefore, we have put this information near the end (in Chapter 8). If your workstation has *not* been configured, you may want to begin with that section after reading this chapter.

Once your workstation has been configured, you can do almost all the tutorial exercises in Chapters 3 through 7 without having actual controllers and I/O set up. However, to make the examples more realistic and to be able to do some things (such as assigning control modules to a controller), you need to have a controller configured.

### A Look Ahead

The tutorials focus on developing the control strategy and operator pictures for a process that involves monitoring the level in a tank and controlling the flow while discharging the contents. The book contains six tutorials:

- Chapter 3, *Learning About the DeltaV Explorer*, shows you how to open the DeltaV Explorer and use the navigation features.
- Chapter 4, *Creating and Downloading the Control Strategy*, steps you through the creation of four modules for controlling the tank process and a sequential function chart that defines the process startup sequence.
- Chapter 5, *Creating Operator Pictures*, introduces the basic tools of the DeltaV Operate application in configure mode and shows you how to create a set of operator pictures complete with colorful graphics, faceplate and detail pictures, pushbuttons, and a trend chart.

- Chapter 6, Using DeltaV Operate in Run Mode, shows the operator pictures from the operator viewpoint and explains how to navigate the pictures, change operating parameters, acknowledge alarms, and perform other operator tasks.
- Chapter 7, Collecting and Displaying Data, shows how you can gather and display system and process data using DeltaV tools and the Excel Add-in.
- Chapter 8, Configuring the Network, Loading and Assigning Licenses, and Setting Up User Accounts, steps you through the procedures for configuring workstations, controllers, and I/O.

## Scenario for the Tank Process Example

The diagram below shows the main parts of a hypothetical process system that controls the flow while discharging liquid from a tank. In the tutorial lessons that follow, you will configure the control strategy for this process and automate a sequence for it.

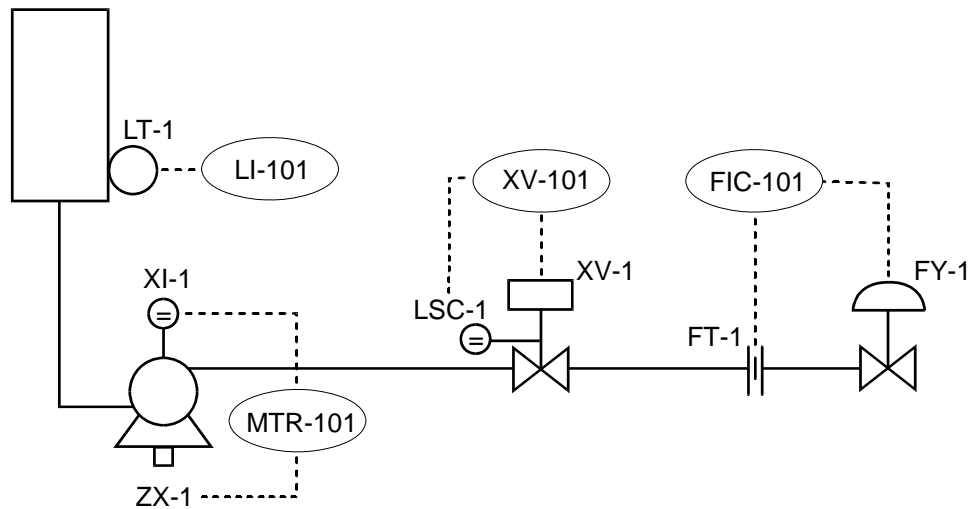

### Control Modules

The first thing you will do is create four control modules for the process equipment and flow loop. In the figure above, the labels in the ovals (LI-101, MTR-101, and so on) are the names you will give to the DeltaV control modules. The labels LT-1, FT-1, XI-1, and so on, are the Device Tags that you will use for the transmitters, valves, and other I/O instruments.

---

Table 2-1 contains information about the control modules and I/O Device Tags that will be used in the tutorial.

*Table 2-1 Control Modules and Associated I/O Device Tags*

<b>Control Module</b>	<b>Description</b>	<b>Purpose</b>	<b>Input Device Tags</b>	<b>Output Device Tags</b>
LI-101	Level Indicator	Monitor level of product in tank	LT-1	
MTR-101	2-State Motor with interlocks	Start and stop pump	XI-1	ZX-1
XV-101	Block Valve	Open/close valve for tank discharge	LSC-1	XV-1
FIC-101	Flow Control Loop	Regulate flow rate	FT-1	FY-1

The Device Tags are assigned to I/O card channels as part of the I/O configuration process, which is described in Chapter 8.

## Sequential Function Chart

After you create the control modules, you will create a module (SFC-START) that uses a Sequential Function Chart algorithm to automate emptying of the tank. The steps in the sequence are listed below.

1. Set to automatic the flow loop controlling the outlet flow valve (FIC-101).
2. Specify a desired setpoint for the flow loop.
3. Wait for the regulatory valve to open, then open the block valve (XV-101).
4. Start the outpump motor (MTR-101).
5. Confirm the motor start.

## Operator Pictures

You will also create a graphical representation of the tank system, similar to the one shown below, for operators to use in monitoring and controlling the process.

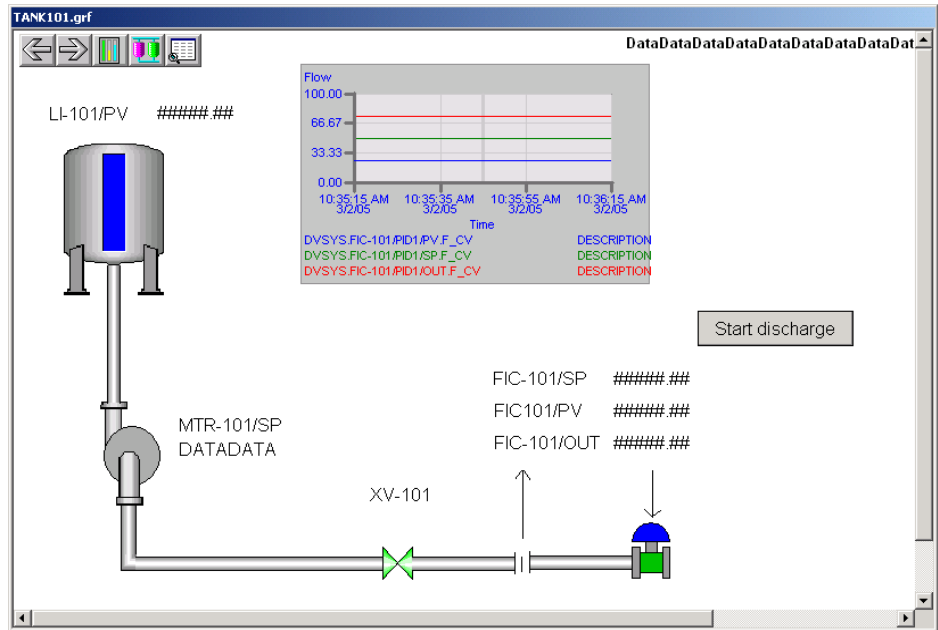

## Let's Get Started!

Now that you have an overall picture of what you can expect to accomplish in the tutorials, you can decide if you want to try the exercises online or simply read through the material.

---

## Chapter 3 Learning About the DeltaV Explorer

The DeltaV Explorer allows you to define system characteristics and view the overall structure and layout of the system hardware and configuration. In addition to viewing your database, you can copy and move objects, modify the properties of objects, and add new objects.

Some of the things you can do with the DeltaV Explorer are:

- Add workstations and controllers to the database
- Add plant areas and control modules to the database
- Add and edit alarm types and edit alarm priorities
- Create named sets that can be used by control modules
- Edit network, controller, and workstation properties
- Download control modules in controllers
- Load and assign licenses
- Export data for use in an external editing tool such as a spreadsheet or database
- Import data from an external editing tool such as a spreadsheet or database

The DeltaV Explorer also provides a fast way to add control modules to your database. When creating your control strategy, you can simply drag-and-drop control modules from the template library into a plant area. While you are still in the DeltaV Explorer, you can edit the module parameters to tailor them to your application. (For more extensive editing, you can use Control Studio.)

You will learn more about the DeltaV Explorer as you go through the tutorials in this book. For now, let's take a quick look at how to open and navigate this application.

# Opening the DeltaV Explorer



## To open the DeltaV Explorer

Click Start | All Programs | DeltaV | Engineering | DeltaV Explorer.

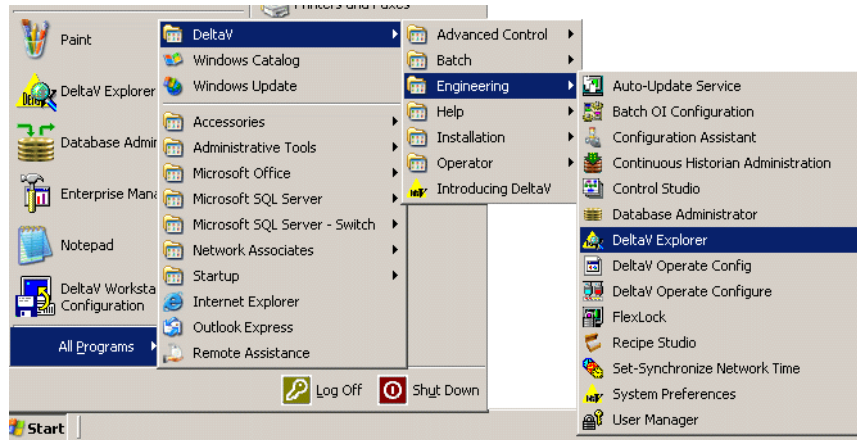

### Tip

*If the Start button is not visible on your Windows desktop, the Windows taskbar/ Start button may be hidden. Point to the lower left corner. If the taskbar/ Start button do not pop up, try the other corners of the screen.*

The DeltaV Explorer opens.

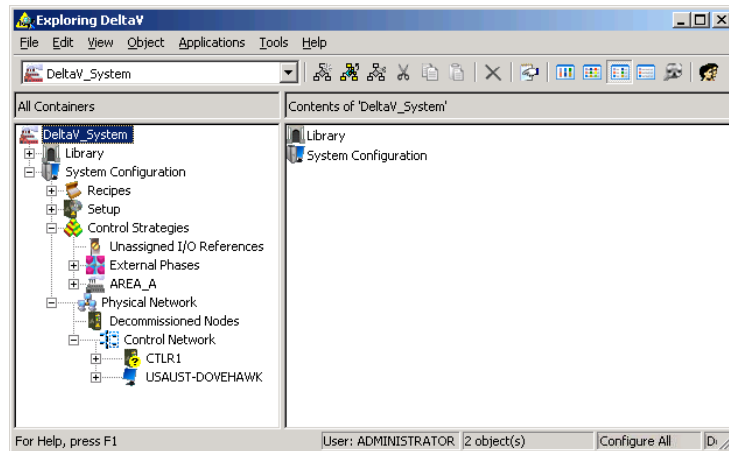



---

## Views

Under the View menu, there are several options you may want to try. You can change from small icons (the default) to large. You can also choose to have additional details displayed in the right pane. As you work with the DeltaV Explorer, you will determine which view option is best for the work you are doing.

## Navigating the DeltaV Explorer

The left pane of the DeltaV Explorer shows the information in your configuration database. The right pane lists the contents of the object selected in the left pane.

### Opening and Closing Levels

Here are a few tips about opening and closing levels in the DeltaV Explorer hierarchy.

To open or expand an object, do one of the following:

- Click the  beside an object.
- Double-click the object's name.
- Select the object and press the right arrow key on the keyboard.

To close or collapse the objects under an object:

- Click the  beside an object.
- Double-click the object's name.
- Select the object and press the left arrow key on the keyboard.

### Documentation Convention for DeltaV Explorer Navigation

In future references to navigating the DeltaV Explorer, we will use a vertical bar between items to indicate that you should open successive levels. For example,

Library | Module Templates | Analog Control | PID\_LOOP

means open the Library, open the Module Templates, open Analog Control, and select (click) the module named PID\_LOOP.

---

# Exploring the Library Templates

In the following exercises, you will use the DeltaV Explorer to look at some of the function block and module templates available in the library.

## Function Block Templates

Function block templates each contain a single function block.



### To see a list of the basic function blocks in the DeltaV library

1. Open the DeltaV Explorer if it is not already open.
2. Expand Library | Function Block Templates.

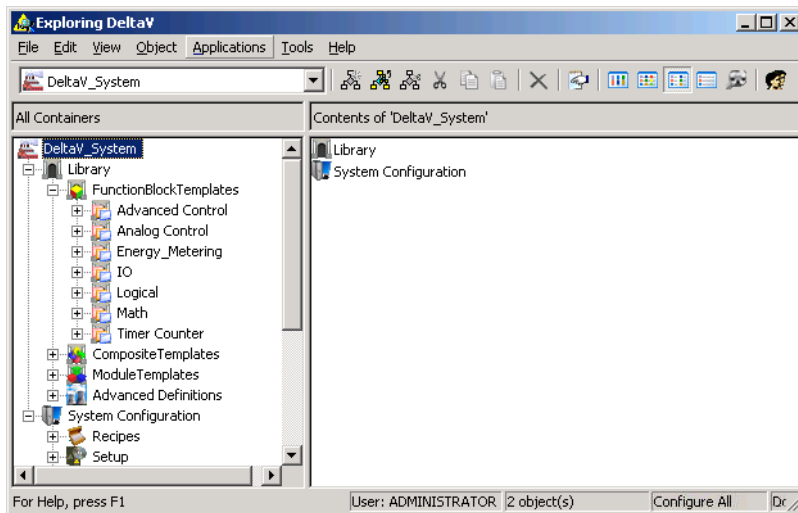

The items listed are the categories of function block templates available.

3.  Click the Details button or select View | Details.

This lets you see at a glance the object name, the type of object, a description, and other details.

#### 4. Select Analog Control.

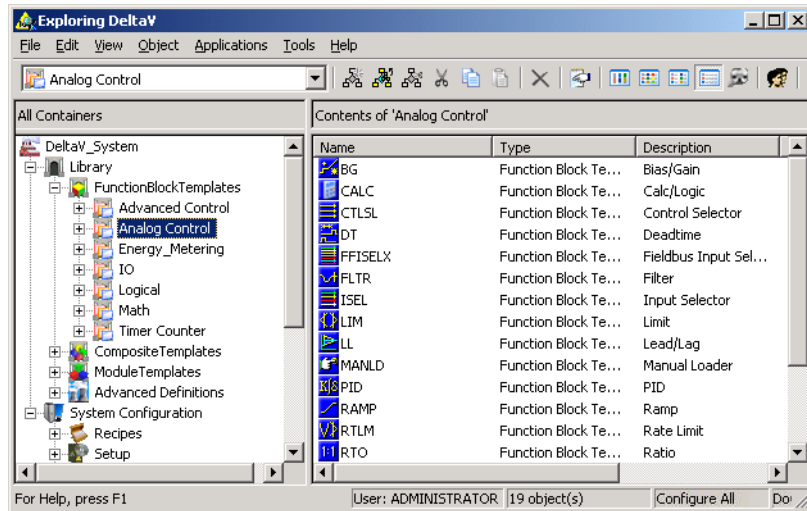

The items listed in the right pane are the basic function blocks used in analog control, including bias/gain, deadtime, filter, lead/lag, and so on.

#### **Tip**

*You can change the width of the columns in the right pane by pointing to the line between columns in the column title bar, holding down the left mouse button, and dragging the line right or left to the column size desired.*

5. Click the other Function Block Template categories to see their contents.
6. Close the Function Block Templates.

## Module Templates

Module templates provide basic control strategies for common control tasks such as analog control, monitoring, motor control, and valve control.



### To see some of the module templates in the library

1. Expand Module Templates and Analog Control.
2. Click Analog Control to see the details on the module templates in this category.
3. Select PID\_LOOP.  
The contents are listed in the right pane.
4. Expand Motors-2State, then select MTR-11\_ILOCK.

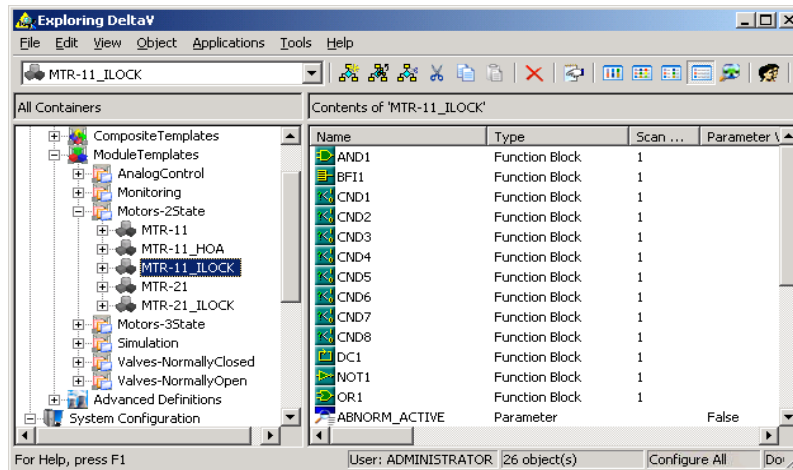

You will use this module template later to configure a pump for the tank process example.

5. Click  beside Motors-2State to close the category.

---

## Context Menus

Pointing to an object and clicking the right mouse button displays a context menu that allows you to perform different tasks, depending on the type of object.



### To see the context menu for a workstation

1. Select System Configuration | Physical Network | Control Network and point to a workstation.
2. Click the right mouse button.

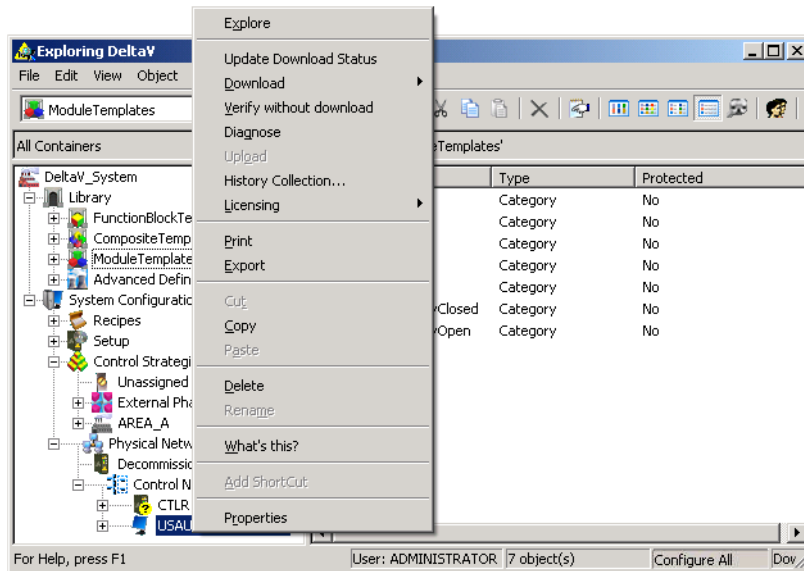

## System Time

The Set/Synchronize Network Time application determines the date and time for the DeltaV system. A single workstation called the master time node keeps time for the entire system and broadcasts the time to the other nodes. The ProfessionalPLUS workstation is the master time node by default. You use the DeltaV Explorer to:

- Set and synchronize the system time
- Define another workstation as the master time node



### To set/synchronize the system time

1. Click Tools | Set/Synchronize Network Time.
2. Specify the new time and date.
3. Click Apply to send the time and date changes to the master time node, which broadcasts the time to all nodes on the Control Network.
4. Click Close to close the dialog box without changing the time.



### To define another workstation as the master time node

1. Navigate to Physical Network (under System Configuration).
2. Click Physical Network.
3. Click the right mouse button, and then click Properties.
4. In the Physical Network Properties dialog box, click Browse and select the workstation that you want to be the source for the master time.

---

### Caution

*Do not change the time using the Windows Date and Time Properties (accessed from the Control Panel or by double-clicking the clock in the Taskbar). Windows Date and Time Properties do not synchronize the time in all the workstations and controllers. Instead, use the Set/Synchronize Network Time tool (accessed from the Tools command in the DeltaV Explorer) to change the system time. This ensures that all workstations and controllers are synchronized.*

*Be aware that setting and synchronizing the system time affects event journals and continuous history.*

---

## On Your Own

Take a few minutes to open and close different levels in the hierarchy to get familiar with the database contents and with the navigation tools.

You can also take a look at some of the context menus. This will give you an idea of how much you can do in the DeltaV Explorer application. At this point, however, do not make any selections from the context menus.

---

## Chapter 4    **Creating and Downloading the Control Strategy**

In the following exercises, you will perform these steps to create the control strategy:

- Create and name a plant area to hold the control modules.
- Create the modules that specify the input, processing, output, alarms, and conditions for the process equipment, control loops, and other parts of the process.
- Create a Sequential Function Chart (SFC) to automate the process.

Strictly speaking, you do not need to create an SFC. You can set up your process system in such a way that an operator would activate specific equipment, change setpoints, and perform other operations. However, in many cases, it is useful to define a Sequential Function Chart to automate the process (or parts of the process, such as startup or shutdown procedures) with minimal operator intervention.

When creating the control modules that make up your control strategy, sometimes you will create a module from scratch (using the basic function blocks), but more often you will start with one of the predefined module templates.

There are a number of ways to create the control modules.

- In the DeltaV Explorer, you can copy a module template from the library by dragging and dropping it onto your plant area and then renaming it.
- In Control Studio, you can start from a module template, modify the module, and save it in your plant area under a new module name.
- In Control Studio, you can start from scratch by dragging and dropping function blocks and other items from palettes of predefined items, connecting the blocks, and modifying block parameters.
- In Configuration Assistant, you can copy a module template from the library.

In the exercises in this chapter, you will learn how to use the first three methods.

### **Note**

*This manual assumes that you are working on a new system or one that is in the beginning stages of configuration—not one that is controlling a process.*

---

## Exercise 1: Creating and Naming Plant Areas

Plant areas are logical, software-based divisions of your control system, which may or may not correspond to physical areas in your plant. Plant areas contain the modules that make up the control strategy. You can have as many as 100 plant areas. How you define your plant areas affects your overall system security scheme because you can authorize access to the system based, in part, on plant areas.

The DeltaV system provides a default system area called AREA\_A. You cannot delete AREA\_A because it is essential for system operations and for performing certain DeltaV functions. If you decide to create additional plant areas, you may want to put your control modules in other areas and reserve AREA\_A for only these system operations and functions. (You can rename AREA\_A to a more meaningful name for your process.)

In the next procedure we will create a plant area named TANK-101 to hold the tutorial modules. The name must be 16 characters or less, and may contain only alphanumeric characters, hyphens (-), and underscores (\_). Hyphens or underscores are typically used to represent spaces between words.





## To add a plant area

1. In the Delta V Explorer, point to Control Strategies and click the right mouse button.

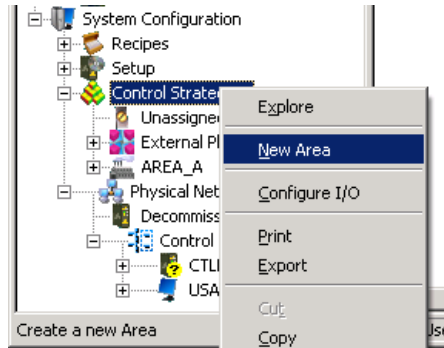

2. Select New Area from the context menu.

A new area, named AREA1, is added and appears in an edit box in the right pane, ready for renaming.

3. Enter a new name (for our example, TANK-101) and press Enter.

(To rename, click the right mouse button and select Rename from the context menu. Type the new name, and press Return.)

Now you are ready to start creating the control modules.

---

## Exercise 2: Using the DeltaV Explorer to Copy a Module (MTR-101)

The tank process has a pump with a two-state (on or off) motor. The motor interlocks under certain conditions. In this exercise, you will use DeltaV Explorer to copy a module template from the Library to the TANK-101 area and rename it. Later, you will use Control Studio to modify the module. (Modifying includes specifying the conditions for the interlocks.)

When you copy a module template from the Library, the module includes history collection. History collection is added to a module or node parameter field and defines the continuous history collection strategy (the value recorded, how it is displayed, the sampling period, and so on) for that field value. Library modules include history collection so that you do not have to set up history collection when you copy a library module to an area. You can add additional history collection to the module if you wish. We will add history collection to the module that we create from scratch in Exercise 5: Creating a New Module (LI-101) from Scratch. Later, we will use the Process History View application to view the field value.

### Note

*In naming the motor (MTR) templates, the following convention was used: the first digit after MTR is the number of outputs; the second is the number of inputs. Thus, MTR-11\_ILOCK is for a motor with one output, one input, and interlocks.*



### To copy the module and rename it

1. In the DeltaV Explorer, open Library | Module Templates | Motors-2State, and select MTR-11\_ILOCK.
2. Drag-and-drop the MTR-11\_ILOCK module onto the TANK-101 plant area.  
To drag-and-drop, point to MTR-11\_ILOCK, hold down the left mouse button, move the pointer to TANK-101, and release the mouse button. TANK-101 now contains a copy of the module, named MTR-11\_ILOC\_1.
3. Open TANK-101 and select MTR-11\_ILOC\_1. The name is highlighted.
4. Click the module name a second time (or click the right mouse button and select Rename from the context menu).

---

**Note**

*If you are copying a module from an area, you must hold down the Ctrl key or the module will be moved rather than copied to the new location. If you are copying a module from the library, it is not necessary to hold down the Ctrl key while dragging the module.*

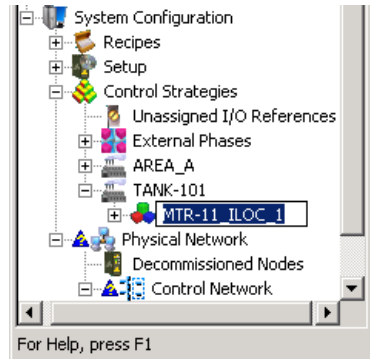

5. Enter the new name for the module: MTR-101.

**Note**

*If you are creating a module in a DeltaV Batch application, module names are limited to 16 characters (letters, numbers, and underscores) and the first character must be a letter. Dashes should not be used in any control module that will be used in the DeltaV Batch system.*

6.  Click the minimize button in the upper right corner to minimize DeltaV Explorer. It appears on the Windows taskbar at the bottom of your screen. To reopen it later, simply click on its name in the taskbar.

It's that easy. You now have a control module in your TANK-101 plant area.

## Introducing Control Studio

Take a few minutes and read the next few pages to learn about the Control Studio application before you open Control Studio and create a module. The Control Studio window has different sections called *views*, that are used to define the characteristics of a module. Each view can be closed or resized individually so that you can optimize the size of the view you are working in.



You can set the size of the overall window by dragging the sides or corners. Then simply select Window | Arrange Windows to automatically reshape the views to a predefined arrangement. (Or you can click the Arrange Windows button on the toolbar after resizing the overall window.)

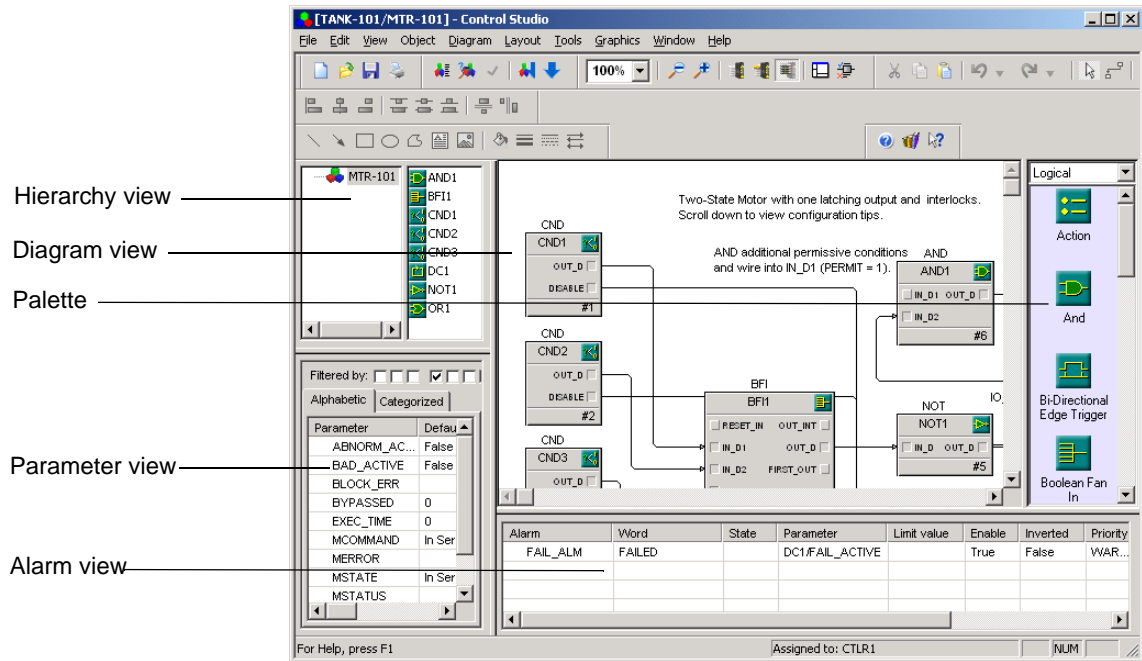

The figure shows the default arrangement of the Control Studio views. The views are:

- **Diagram View** - used to create a module's control algorithm graphically on a diagram (includes a palette of items that can be placed on the diagram)
- **Parameter View** - used to define the module's characteristics, alarm limits, default values, mode, and other parameters
- **Hierarchy View** - used to see a hierarchy of the elements that make up the module
- **Alarm View** - used to see the alarms that are defined, their limits, priorities, and other information

The palette shows the items that can be added to the diagram using the drag-and-drop technique. Six palettes are available. Five contain the basic function blocks from the Library; one has Special Items. You can change to a different palette by clicking on the palette title bar and selecting a new palette.

## Note

*If the palette is not showing, point to the edge of the Diagram window, hold down the mouse button and drag the side of the window to resize it to show the palette column.*

The palette can be moved from one side of the Diagram View to the other. To do this, point anywhere on the palette, click the right mouse button, and select Switch Sides from the menu. (You can also select View | Palette | Switch sides.)

---

The items in the palette may be displayed with either large or small icons. To change the selection, point anywhere on the palette, click the right mouse button, and select the desired icon size. (Alternatively, you can select the menu option View | Palette and choose the icon size.)

**Note**

*If another user has changed the selections under Tools | Diagram Preferences, your pictures may look different than the ones in this book. The default settings are as shown below:*

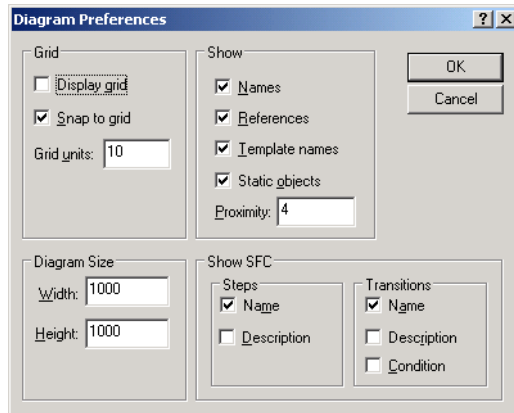

## Parameter Filtering

Parameters are data used in module function blocks to perform calculations and logic. Some parameters are defined and unchangeable for certain function blocks. Some default to a most common value, but may be modified. Others must be set by the user.

Some function blocks have a large number of parameters. To help you quickly access the ones you need, a number of parameter filtering options are available. The Common configuration filter setting lists in the Parameter view the parameters that are most often used for the configuration of the control module. These parameters generally have default values set, but should be modified to fit the application. Parameters and parameter filtering are described in detail in the Books Online *Configuration* manual.

---

## Exercise 3: Creating a Control Module (XV-101) in Control Studio Using a Library Template

In this exercise you will use a module template to create a control module for the block valve. This time you will use Control Studio, rather than the DeltaV Explorer, to create the module from a library template.

### Opening Control Studio



#### To open Control Studio and create a module from a template

1. Click the Start button, point to All Programs | DeltaV | Engineering, and click Control Studio.

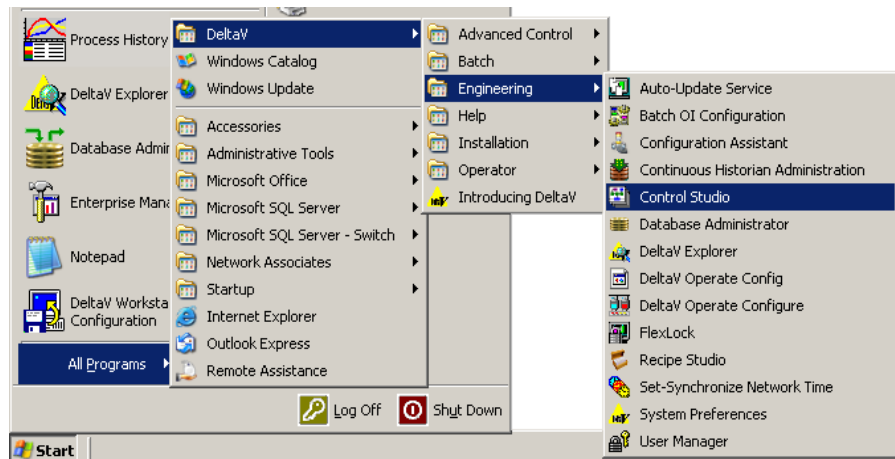

(Another way to launch Control Studio is to click its button in the DeltaV Explorer toolbar. We have minimized the Explorer to keep the desktop uncluttered; if you are comfortable using Windows, you can have several DeltaV application windows open at once.)

2. To choose a template from the library, click File | New. On the New dialog, select Start from Existing and click the Browse button.

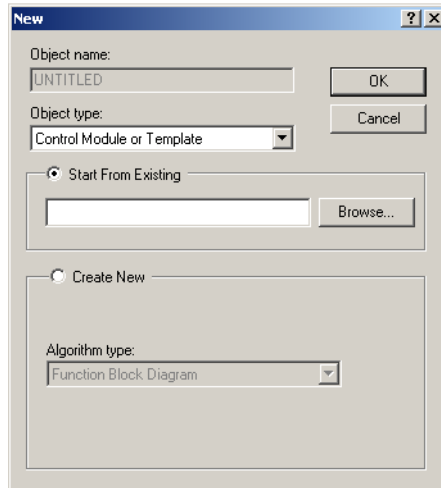

The Browse dialog box appears.

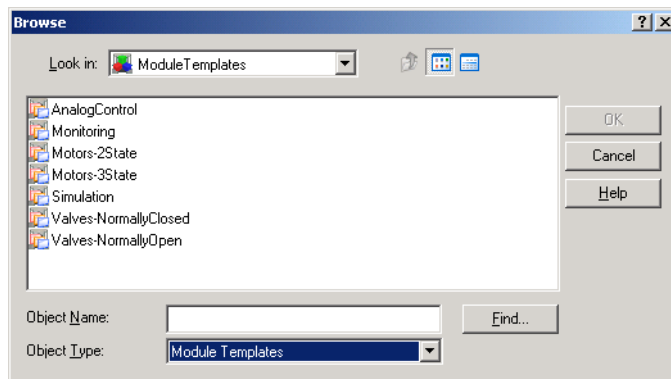

3. Click in the Object Type field at the bottom of the dialog box, and select Module Templates.
4. In the large center box that lists the contents of Module Templates, double-click Valves-Normally Closed.
5. From the contents of Valves-Normally Closed, select VLVNC-11. (This name is automatically placed in the Object name field.)
6. Click OK in the Browse dialog box.

7. Click OK in the New dialog box.

Control Studio now displays an untitled copy of the VLVNC-11 module.

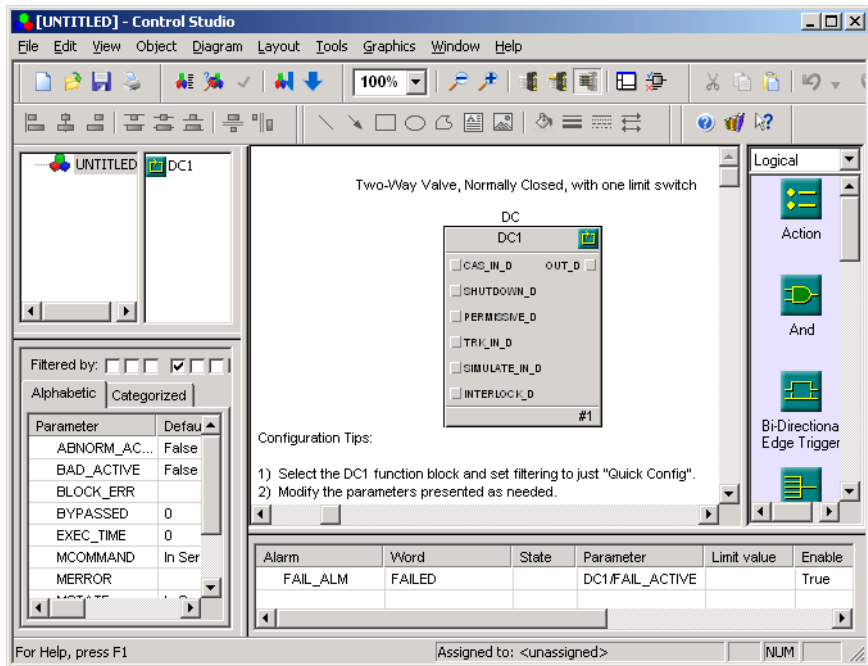



---

## Modifying the XV-101 Control Module

The module template is fairly simple, consisting of only one function block. To customize the module for the tank application, all you need to do is identify the Device Signal Tags for the input and output. (Device Tags are assigned to the I/O channels as part of the I/O card configuration process, described in Chapter 8.) The Device Tags for the tank application are listed in the table in Chapter 2. Refer to the Glossary for definitions of Device Tag and Device Signal Tag.



### To modify the control module

1. In Diagram View, click the Device Control function block, DC1.

Four small black squares (called “handles”) appear at the corners to indicate that this block is the currently selected item on the diagram.

Filtering may be applied to limit the list of parameters displayed.

2. Select a parameter, click the right mouse button, and select Filter Parameter List.

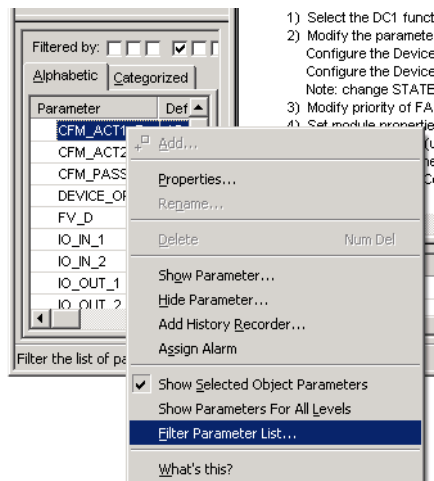

The Parameter Filtering dialog box opens.

3. Select Common configuration to display the group of parameters that are identified as the most commonly used in process control configuration and select On-line to display the parameters most commonly used for operating a process.

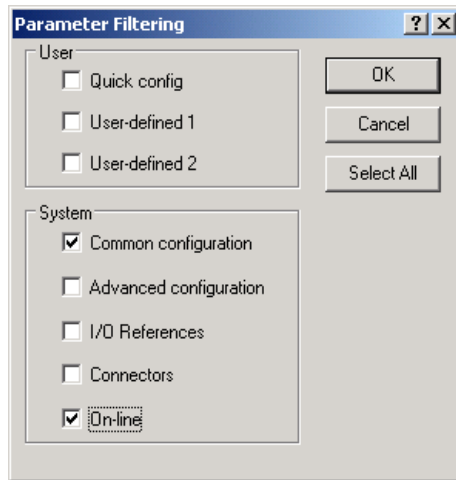

4. Deselect any other boxes that may be checked by clicking on each, and click OK to close the dialog.
5. In the Parameter View, scroll down the list if necessary, and select IO\_IN\_1.
6. Double-click the IO\_IN\_1 parameter to open the Properties dialog box.
7. In the Device Tag field, enter LSC-1 and click OK. (LSC-1 is the Device Tag used in our tank example for Limit Switch-Closed.)

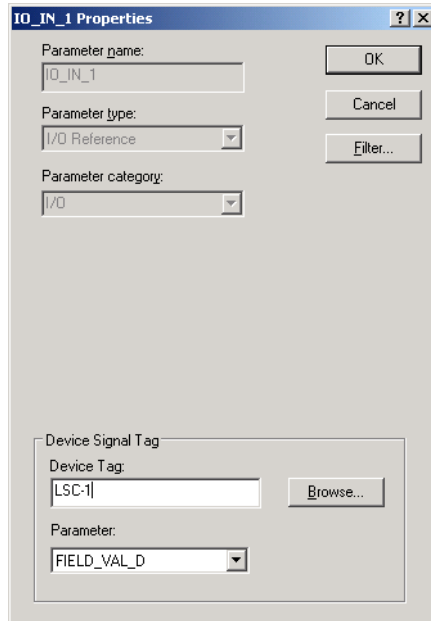

The IO\_IN\_1 parameter is given a value of FIELD\_VAL\_D. (You can click in the Parameter field to see this value. It also appears in the Parameter view.) LSC-1, together with the FIELD\_VAL\_D parameter define the Device Signal Tag (DST).

(If you have configured placeholders for the I/O cards, as described in Chapter 8, you can browse for the Device Tags. Clicking the Browse button opens a dialog box that lists all the configured I/O card channels and their assigned Device Tags. You can scroll down the list, select the appropriate Device Tag, and click OK. Click the Alphabetic tab to alphabetize the list and scroll past the entries beginning with COxx to get to the Device Tag names such as LSC-1.)

8. In the Parameter View, double-click IO\_OUT\_1.

The Properties dialog box appears.

9. In the Device Tag field, enter XV-1 and click OK.

XV-1 is the Device Tag used in our example for the Block Valve. The DST is given a default parameter value of OUT\_D.

The Parameter list should now look like this:

Note the changes to the input and output parameters.

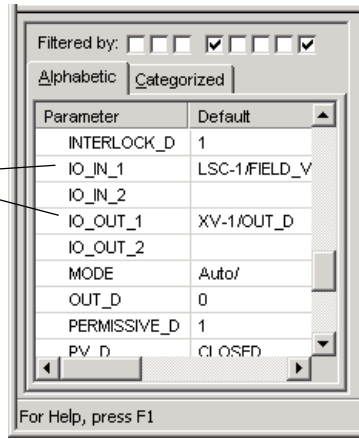

The screenshot shows a software window titled "Parameter list". At the top, there is a "Filtered by:" section with several checkboxes, two of which are checked. Below this are two tabs: "Alphabetic" and "Categorized", with "Categorized" selected. The main area contains a table with two columns: "Parameter" and "Default". The table lists several parameters, with arrows pointing to the "IO\_IN\_1" and "IO\_OUT\_1" rows from the text on the left. At the bottom of the window, there is a text label "For Help, press F1".

Parameter	Default
INTERLOCK_D	1
IO_IN_1	LSC-1/FIELD_V
IO_IN_2	
IO_OUT_1	XV-1/OUT_D
IO_OUT_2	
MODE	Auto/
OUT_D	0
PERMISSIVE_D	1
PV_D	CI OSFD

---

## Exercise 4: Finishing Steps for All Control Modules

There are four things that you should do every time you create a control module.

- Identify the operator pictures that will be associated with the module.
- Assign the module to a controller.
- Save the module to the database.
- Verify the module's configuration.

The procedures for accomplishing these tasks follow. (An additional step is downloading. Modules can be downloaded to a controller individually. However, we will download our whole control strategy at one time, as you will see at the end of this chapter.)

### Identifying the Operator Pictures Associated with a Module

Three types of operator pictures are associated with control modules: the Primary Control picture, the Faceplate picture, and the Detail picture.

You will see what these pictures look like and how they are used in Chapter 5, Creating Operator Pictures and Chapter 6, Using DeltaV Operate in Run Mode. For now, you simply need to know how to associate the module with the pictures.



#### To identify the Primary Control picture associated with this control module

1.  In Control Studio, click the Properties button on the toolbar (or select File | Properties).

The Properties dialog box appears.

2. Click the Displays tab and, under Primary Control, enter TANK101.

This will be the name for the Primary Control picture that will be associated with this control module. You will create the Primary Control picture TANK101 later (in Chapter 5).

#### **Note**

*Picture file names must be alphanumeric and cannot contain the hyphen character, begin with a number, or use a Visual Basic reserved word.*

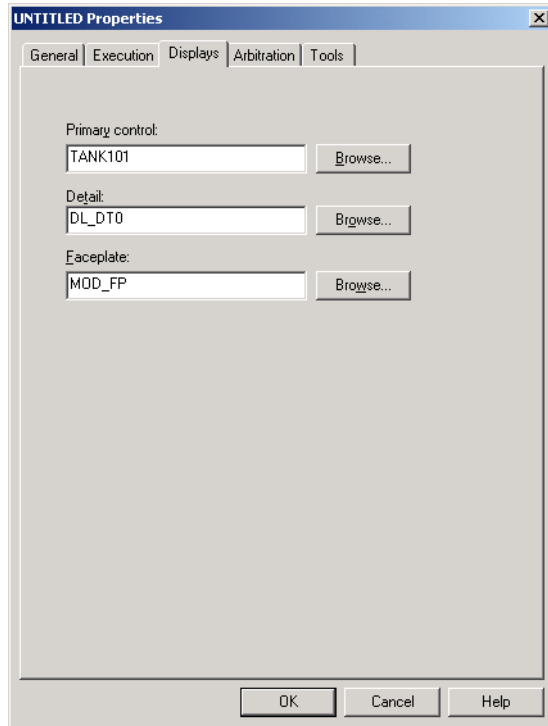

Note that the fields for Detail picture and Faceplate picture are already filled in. All the control module templates in the library have pre-defined Detail and Faceplate pictures associated with them.

3. Click OK.

## Assigning the Module to a Controller Node

If you configured a controller or created a placeholder controller, you will be able to assign the module to the controller. If you have not configured a controller, go to the section “Configuring the Controller Node” on page 8-17 for information on how to do this. For information on connecting your controller hardware, refer to the hardware manual, *Installing Your DeltaV Digital Automation System*.



## To assign the control module to a controller node

1.  Click the Assign to Node button on the toolbar (or select File | Assign to Node).

The Browse dialog box opens.

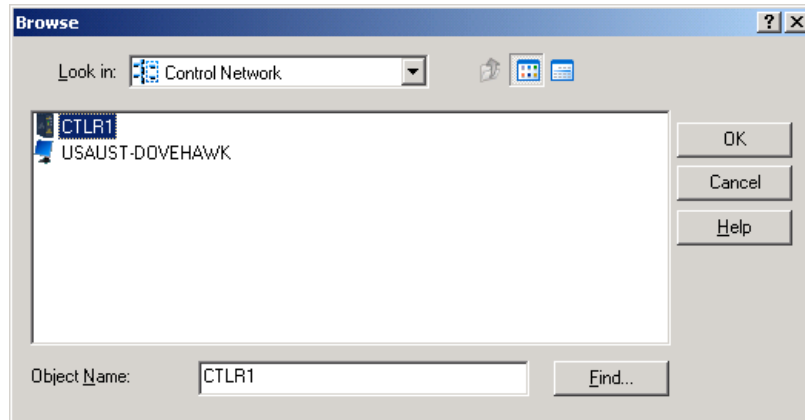

2. In the Browse dialog box, select the controller.
3. Click OK.

## Saving the Module



### To save the control module

1.  Click the Save button on the toolbar (or select File | Save or File | Save As).  
The Browse dialog box opens.
2. In the Objects Type box, select Modules.
3. In the Look In field select Control Strategies, and double-click TANK-101. MTR-101, the module we created earlier in the DeltaV Explorer, is in the list of modules.

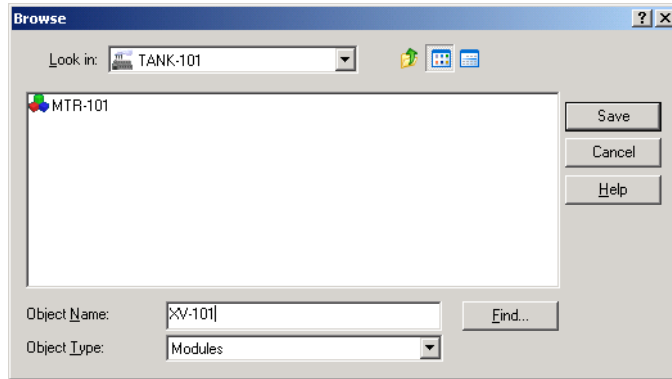

4. In the Object Name box, type XV-101 as the name for this module and click Save.

## Verifying the Module Configuration



### To verify the module's configuration



1. Click the Properties button on the toolbar (or select File | Properties).  
The Properties dialog box opens.
2. Click the Tools tab.



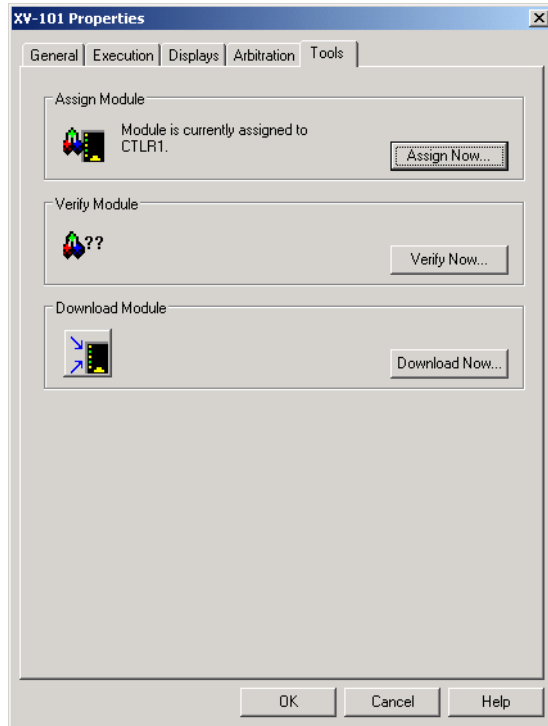

3. Click the Verify Now button.

A message is displayed that the verification completed successfully.

4. Click OK to close the message box and click OK on the Properties dialog.

You now have two control modules, one for the motor and one for the block valve. You have learned quite a bit, which you will be able to put to use in the following exercises.



If you want to take a break you can close Control Studio by clicking the Close button in the upper right corner. Before starting the next exercise, simply start Control Studio from the Start button.

---

## Exercise 5: Creating a New Module (LI-101) from Scratch

In this exercise, you will use Control Studio to create from scratch a module to monitor the tank level. The module will have one analog input function block (to allow reading of the analog input signal) and one output, a promoted parameter. Promoted parameters are available under the Special Items palette. The promoted output parameter allows this value to be more easily accessed systemwide.

Four other changes will be made.

- The IO parameter of the analog input block will be edited to identify the Device Signal Tag for the level transmitter, LT-1.
- The OUT\_SCALE parameter on the analog input block will be changed from the default value of 100 to 10,000 to reflect the 10,000-gallon capacity of the tank.
- The HI\_HI\_LIM value will be changed to 1000.
- History collection will be added to the PV of the AI block so that the tank level can be trended in the Process History View application.



### To create a new module

1.  In Control Studio, click the New module button on the toolbar (or select File | New). The New dialog box appears.

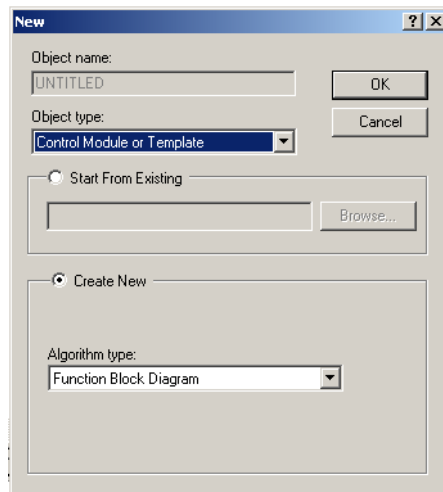

2. Click OK to accept the default settings in the New dialog.

Control Studio opens with a blank, untitled Function Block diagram.



### To add and modify a function block for analog input

1. Click the words above the palette on the right side of the screen and select IO from the dropdown menu. A list of function blocks related to I/O appears.
2. Select the Analog Input (AI) function block from the palette; drag-and-drop it onto the Function Block diagram.

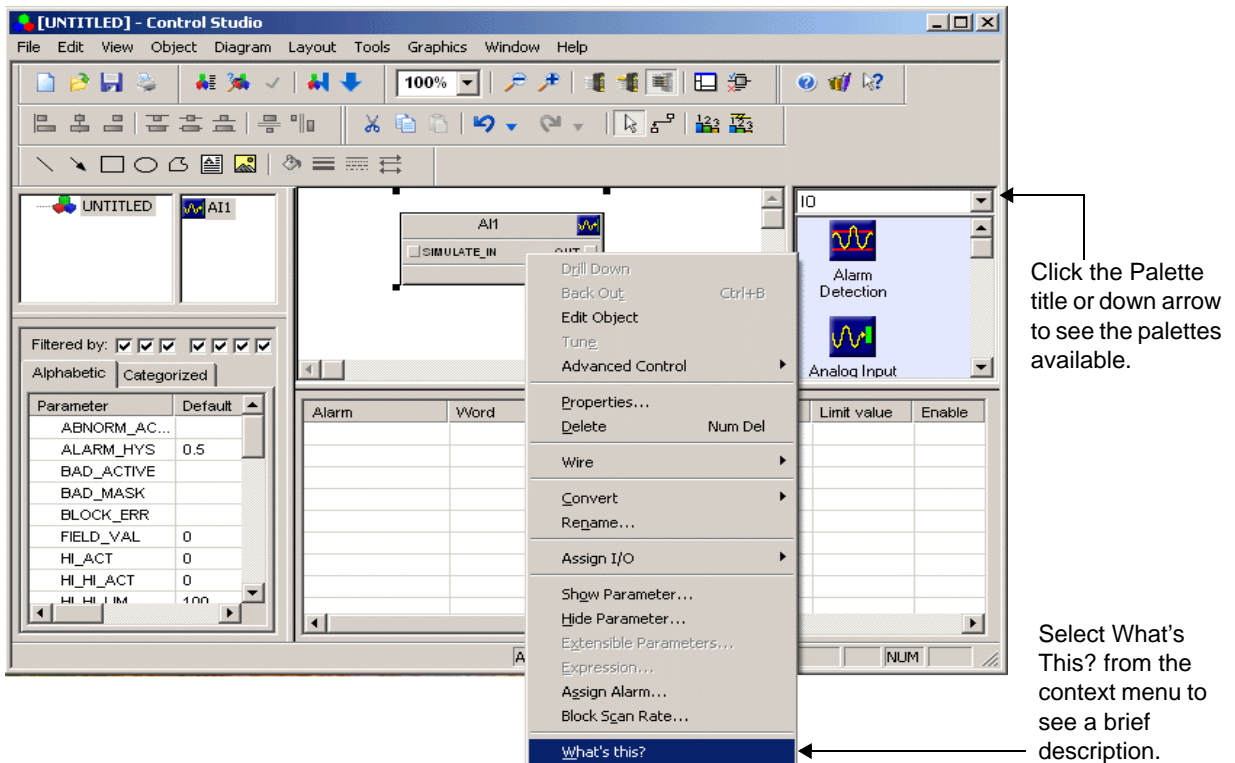

3. To find out more about this function block, point to the AI block, click the right mouse button and select What's this? from the menu.



### (AI) Function Block

The Analog Input (AI) function block accesses a single analog measurement value and status from an I/O channel. You can configure the channel type for each I/O channel to be the transmitter's 4 to 20 mA signal or the digitally communicated primary or non-primary variable from a HART transmitter. This block can run in the DeltaV controller or execute in a Fieldbus device.

The AI function block supports block alarming, signal scaling, signal filtering, signal status calculation, mode control, and simulation.

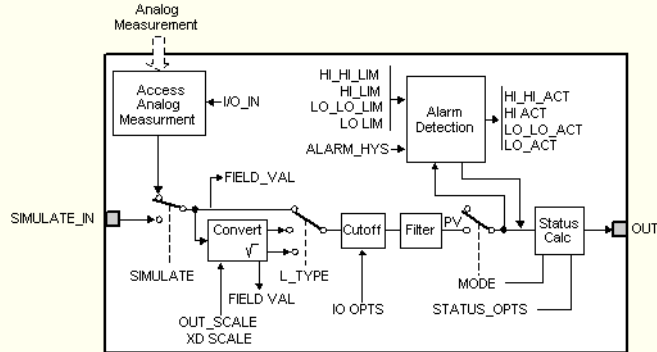

SIMULATE\_IN is the simulated value from another block that is used by the Analog Input function block if simulation is enabled.

**Note** When the Analog Input block is extended to a Fieldbus device, SUBSTITUTE\_IN parameter is used as the simulated value.



Reference

### Tip

To access detailed information, you can click the Books Online (Reference) icon at the end of the pop-up text. After reading about the function block, click the close button in the Books Online window to close that application and return to Control Studio.

4. In the list of parameters, double-click HI\_HI\_LIM (or click the right mouse button and select Properties).
5. In the Properties dialog box, change the value to 1000 and click OK.
6. Double-click the IO\_IN parameter.
7. In the Properties dialog box, enter the Device Signal Tag, LT-1 (for the level transmitter), and click OK. The system selects the default parameter.

In the Parameter list, note that the parameter named L\_TYPE (linearization type) has a default value of Indirect. This must remain Indirect for you to be able to define the Engineering Units of the input.

8. To set the Engineering Units (EU) and the scale, double-click the OUT\_SCALE parameter.

The screenshot shows a dialog box titled "OUT\_SCALE Properties". It has a standard Windows-style title bar with a question mark icon and a close button. The dialog is divided into two main sections. The top section contains three input fields: "Parameter name" (containing "OUT\_SCALE"), "Parameter type" (containing "Scaling"), and "Parameter category" (containing "/D"). To the right of these fields are three buttons: "OK", "Cancel", and "Filter...". The bottom section is titled "Properties" and contains four fields: "100% scale" (containing "10000"), "0% of scale" (containing "0"), "Engineering unit" (a dropdown menu showing "gal"), and "Decimal places" (a spinner box set to "1").

9. Modify OUT\_SCALE as follows:
  - Change the 100% scale from 100 to 10000 (for 10,000 gallons).
  - For Engineering unit descriptor, select gal (for gallons).
10. Click OK.

For our example, we would like to make the output value easy to reference system wide. Promoting the parameter to the module level allows the value to be referenced throughout the system as LI-101/PV rather than LI-101/AI1/OUT.



## To add a module-level parameter for output of the process value

1. Select the Special Items palette from the Palette pulldown menu.
2. Select the Output parameter, click the right mouse button, and select What's This? from the menu to get a description.

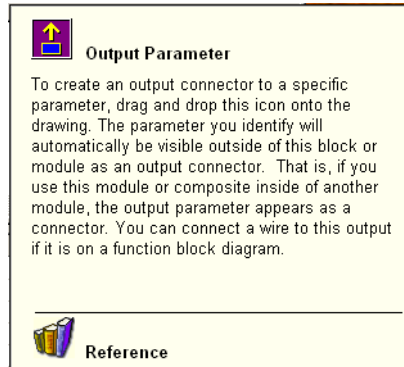

3. Drag-and-drop the Output parameter onto the diagram to the right of the AI function block.  
A Properties dialog box appears.
4. Change the parameter name to PV (for process value).
5. Select Floating point with status in the Parameter field, select I/O in the Parameter category field, accept the default status (it will be overwritten), and click OK.

The block named PV now appears on the Function Block Diagram.



## To add history collection to the PV

1. Select the AI block in the Diagram View.
2. In the Parameter View list, click the right mouse button on PV and select Add History Recorder.

The Add History Collection dialog opens.

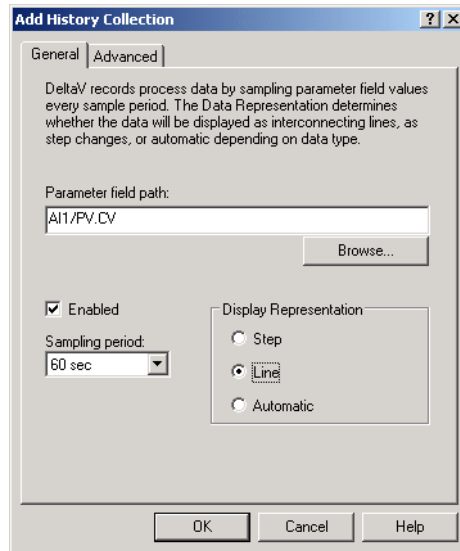

3. The path to the current value for the PV (AI1/PV.CV) appears in the Parameter field path box. (If this path does not appear here, click the Browse button and browse for it.)
4. Click Enabled.
5. Click Line as the Display Representation.

### **Note**

*The line style can be changed in the Process History View application.*

6. Use the default value of 60 seconds as the sampling period.
7. Click OK.

Later, we will assign the area (TANK-101) to the Continuous Historian subsystem, enable continuous history collection on the workstation, and download the workstation in order to collect and view the history for the field values.



## To connect the two blocks

-  Click the Connect button on the toolbar. (The focus must be in Diagram View for this button to be active.)  
The pointer changes to a pencil.
- Draw a line from the Out parameter on the AI block to the PV parameter.  
The pencil changes to a \* when you are over the right spot for making the connection.

### Tip

 *If you want to rearrange the diagram, you need to change the pointer back to an arrow. Simply click a blank spot on the diagram or select the arrow button from the toolbar. Then you can click one of the function blocks and move it. The connector line moves and resizes automatically.*

Your finished diagram should look like this:

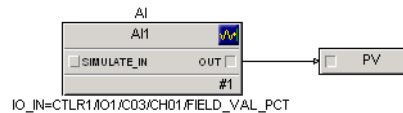



---

## Finishing the LI-101 Module



### To finish the module

We have abbreviated the instructions for finishing the module. If you have forgotten any of the steps, refer to the details in Exercise 4.

1. Select File | Properties and set the Primary Control picture to TANK101.
2. Assign the control module to the controller.
3. Save the control module in area TANK-101 under the object name LI-101.



When you have finished, close Control Studio by clicking the Close button in the upper right corner. Do not simply minimize Control Studio. In the next exercise, we will show you a new way to open Control Studio directly from the Explorer. If you minimize Control Studio, you will have two copies of Control Studio open.

If you have the DeltaV Explorer minimized, restore it to full size by clicking on its name in the Windows taskbar at the bottom of your screen. Otherwise, open it from the Start button.

## Exercise 6: Creating a PID Control Loop (FIC-101)

In this exercise, you will use the PID\_LOOP module template from the Analog Control group as the basis for a module to control the outlet flow valve. This time, you will use the DeltaV Explorer to create the module, assign it to a controller, and modify most of the parameters.



### To create the control module and assign it to the controller

1. In the DeltaV Explorer, select Library | Module Templates | Analog Control | PID\_LOOP and drag it to the TANK-101 area.
2. In the TANK-101 area, select PID\_LOOP\_1 and rename it to FIC-101.
3. Select FIC-101, click the right mouse button, and select Assign. Alternatively, drag-and-drop FIC-101 from the TANK-101 area to the controller object under the Physical Network | Control Network.
4. In the Browse dialog box, select the controller and click OK.



## To modify the control module

1. Double-click FIC-101 in the left pane to open the module.
2.  If necessary, click the List button to display the contents of the right pane as shown in the next figure.
3. Select PID1 (the PID loop function block) and make the following changes to the parameters in the right pane.

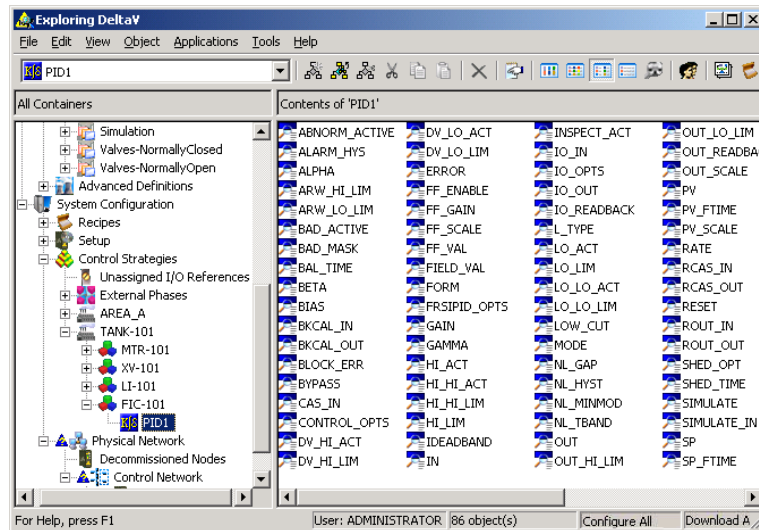

- a. Double-click IO\_IN. In the Properties box, enter the Device Tag of FT-1.
- b. Double-click IO\_OUT and enter the Device Tag of FY-1.
- c. Double-click GAIN and change the value from .5 to 1.
- d. Double-click RESET and change the value from 10 to 3 (that is, 3 seconds per repeat).
- e. Double-click PV\_SCALE and change the Engineering unit descriptor to GPM (gallons per minute).

4. In addition, note these default settings for other parameters:
  - On the CONTROL\_OPTS (control options) parameter, Direct acting is not selected, meaning that it is set as reverse acting.
  - On the IO\_OPTS (I/O options) parameter, Increase to close is not selected, meaning that it is set as increase to open.

## Looking at the Module in Control Studio

Now let's take a look at the module in Control Studio.



### To open the FIC-101 module for further editing in Control Studio

1. Select FIC-101 in the DeltaV Explorer.
2. Click the right mouse button and select Open | Open with Control Studio from the context menu.

Control Studio opens with module FIC-101 preloaded.

3. Resize the individual views as necessary so that your screen looks similar to this:

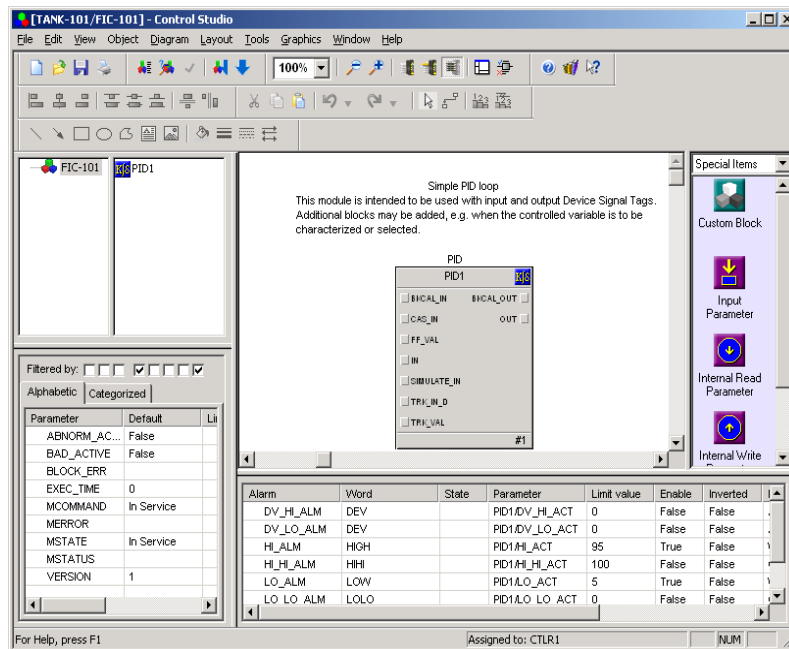

---

## Modifying Alarms for the PID Loop Module

Alarms are used in the DeltaV Operate application (in run mode) to notify operators about changes in the process that might require their attention. Alarms are visible on an alarm banner at the bottom of the operator picture, as well as on any Faceplate pictures or other pictures that are set to show alarms.

Alarms have been set up in the PID\_LOOP template which we used as the basis for the FIC-101 module. Take a closer look at the alarms that appear in the Alarm view, the bottom pane in Control Studio.

Alarm	Word	State	Parameter	Limit value	Enable	Inverted	Priority	%P1 parameter
DV_HI_ALM	DEV		PID1/DV_HI_ACT	0	False	False	ADVI...	PID1/SP
DV_LO_ALM	DEV		PID1/DV_LO_ACT	0	False	False	ADVI...	PID1/SP
HI_ALM	HIGH		PID1/HI_ACT	95	True	False	WAR...	PID1/PV
HI_HI_ALM	HIHI		PID1/HI_HI_ACT	100	False	False	CRITI...	PID1/PV
LO_ALM	LOW		PID1/LO_ACT	5	True	False	WAR...	PID1/PV
LO_LO_ALM	LOLO		PID1/LO_LO_ACT	0	False	False	CRITI...	PID1/PV
PVBAD_ALM	IOF		PID1/BAD_ACTI...		True	False	CRITI...	

Only three of the alarms, HI\_ALM, LO\_ALM, and PVBAD\_ALM are enabled. For the example, you will modify the HI\_ALM slightly to change the value from 95 to 90. This means that an alarm will be activated if the flow goes above 90 gallons per minute.



### To modify the alarm

1. Double-click HI\_ALM (or select HI\_ALM in the Alarm View, click the right mouse button, and select Properties).

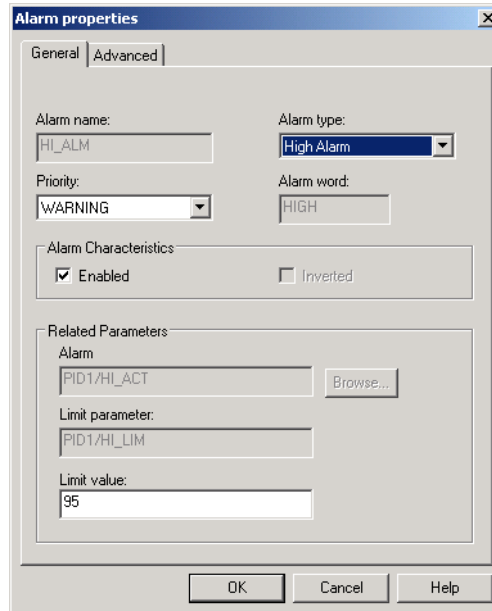

2. Change the Limit value from 95 to 90 and click OK.

## Finishing the FIC-101 Module



### To finish the module

You have already named the module and assigned it to the controller.

1. Set the Primary Control picture to TANK101.
2. Save the module.

---

## Exercise 7: Modifying the Motor Module (MTR-101)

Earlier in this chapter, in Exercise 2, you created the MTR-101 module in the Explorer by copying the MTR\_11\_ILOCK template to the TANK-101 area. In this lesson, you will open the module for editing in Control Studio. This module looks complex at first, but becomes more understandable as you look at the individual parts.

### Tip

*If you have access to a printer, you can print out the diagram, which includes Configuration Tips. Select File | Print and choose the diagram box.*

The motor module, shown later in this exercise, includes these function blocks, all of which are from the palette group named Logical:

- Eight Condition blocks (CND)
- Boolean Fan Input (BFI) block
- Logical And (AND), logical Not (NOT), and logical Or (OR) blocks
- Device Control (DC) block

The CND, BFI, AND, NOT, and OR blocks are used to specify the interlock logic. The DC block is for motor control.

Some of the things you will do in this exercise are:

- Delete the excess condition blocks.
- Specify the interlock conditions using the remaining three condition blocks.
- Specify the Device Signal Tags for the input and output parameters.
- Change the Detail picture associated with this module to one that has three conditions rather than eight.



### To open the module for editing

1.  In Control Studio, click the Open button (or select File | Open).  
The Browse dialog box appears.
2. Select Modules in the Object Type field.
3. If TANK-101 is not in the Look in field, open the pull down list and select Control Strategies. In the large center box that lists the contents of Modules, double-click TANK-101.

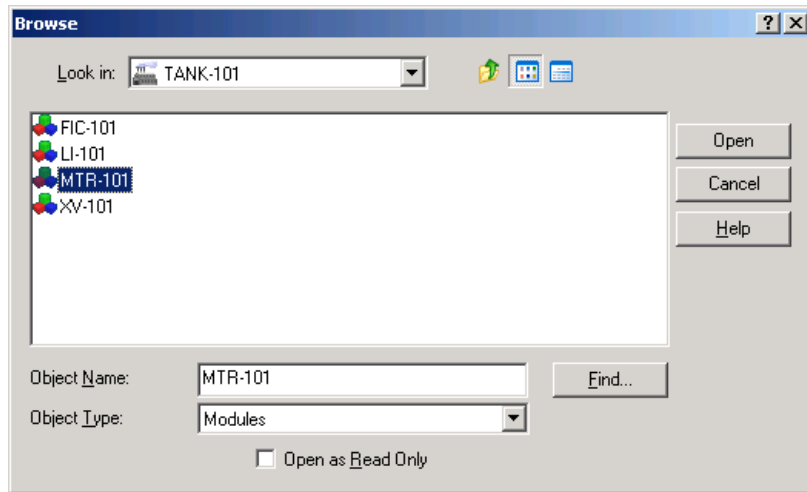

4. Select MTR-101 and click Open.

The MTR-101 module is displayed in the Diagram view.

5.  Enlarge the Control Studio application window to its full size by clicking the Maximize button in the upper right corner.
6. Change the palette to Logical so you can easily access the descriptions for the individual blocks.

(Remember, you can point to a palette item or a function block on the diagram, click the right mouse button, and select What's This? for a description.)

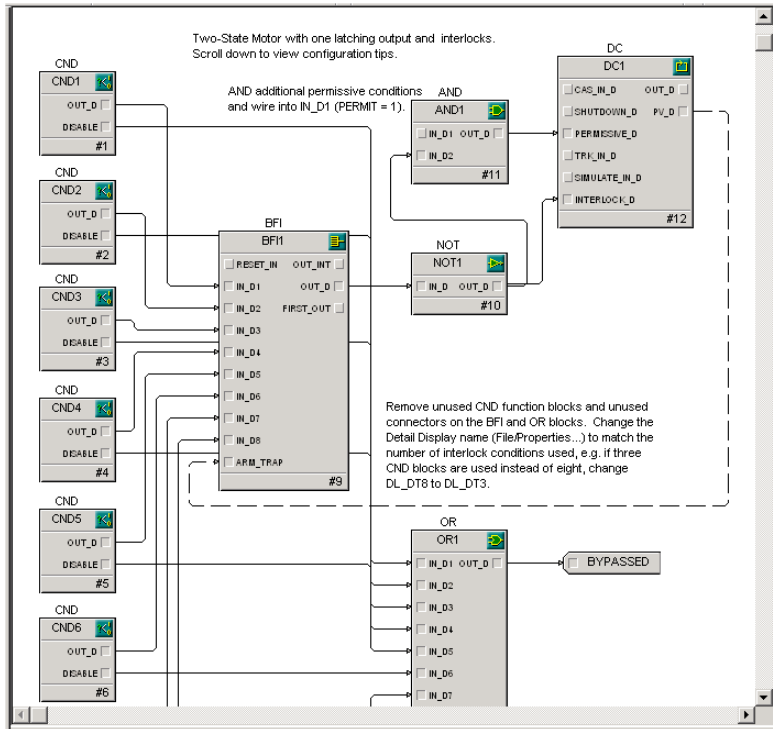

## Removing the Excess Condition Blocks

Although it does not matter if there are unused condition blocks on the Function Block Diagram, it will improve the appearance to delete the ones that will not be needed. You can remove the excess condition blocks and their connecting lines by selecting one or more than one and pressing the Delete key. To select more than one, click them while holding the Shift key, or drag a selection box around the whole group.





## To remove the excess condition blocks

1. Place the mouse pointer outside the upper left corner of CND4.
2. Click and hold the mouse button, then drag to include the lower right corner of the CND8 box.

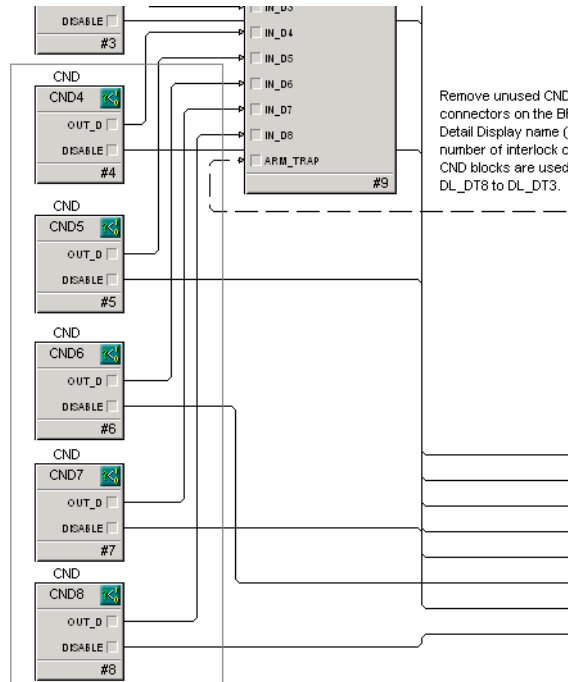

The boxes named CND4 Through CND8 should be selected. If not, click a blank spot and try again.

3. Press the Delete key to delete the selected items. (Or click the right mouse button and select Delete from the context menu.)
4. Click Yes when asked to confirm the deletion.

The blocks and connection lines are deleted.

---

## Specifying Conditions with the Expression Editor

The motor should shut off if any of the following three conditions occurs:

- The block valve is closed.
- The tank level is less than 100 gallons.
- The regulatory valve is less than 5 percent open.

Now we need a way to specify these requirements. The condition blocks serve this purpose. Each condition will have associated with it an expression that identifies the condition precisely in mathematical or logical terms. Expressions are made up of operands, operators, functions, constants, and keywords.

Two guidelines for writing an expression for a condition are:

- The expression must end with a semi-colon (;).
- Parameter values are enclosed by single quotes (').

The DeltaV system provides an Expression Editor to help you define these expressions. After you have entered an expression, the Expression Editor checks the syntax, indicates problems, and identifies any unresolved parameters. The Expression Editor is accessed through the Object menu or context menu (right mouse click) for Action, Calculation/Logic, and Condition function blocks. The dialog box for the Expression Editor looks like this:

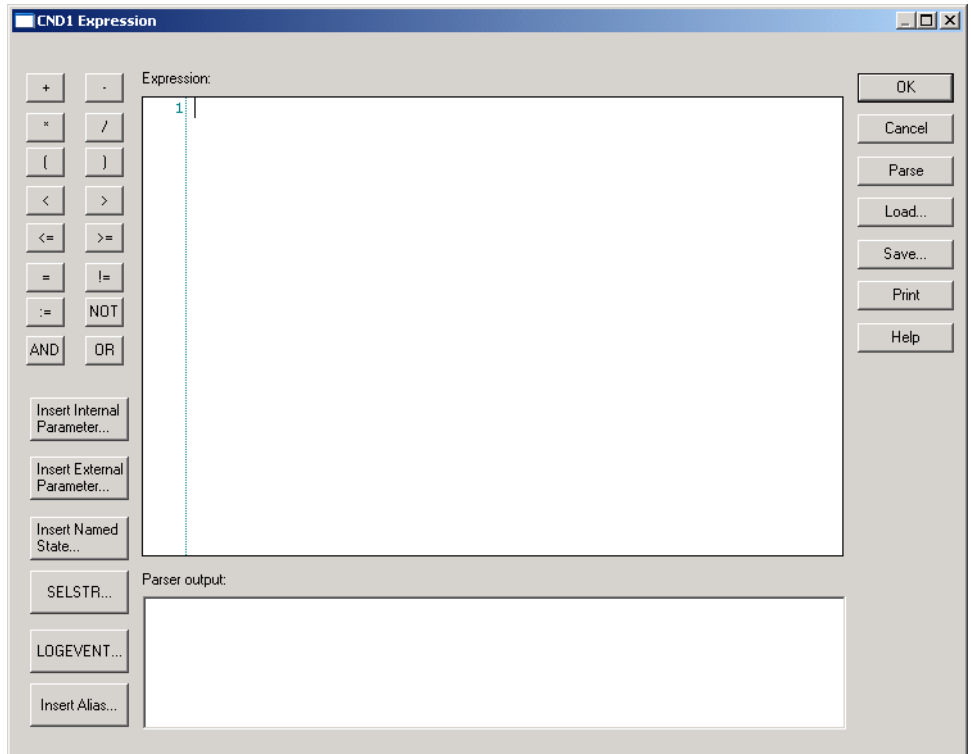

The Expression Editor inserts the characters shown in the following table when constructing expressions. If you type the expressions without using the Expression Editor, you need to use these characters in the same way.

Table 4-1 Characters for Constructing Expressions

Characters	Use	Example
/	Precedes a reference to an internal parameter (one within the current module). Use the Insert Internal Parameter button to browse for these parameters.	
^/	Precedes a reference to an internal parameter up one block level. Use the Insert Internal Parameter button to browse for these parameters.	
//	Precedes a reference to an external parameter (one within another module). Use the Insert External Parameter button to browse for these parameters.	'//XV-101/DC1/PV_D.CV'
# #	In Batch processing, used to enclose an alias.	
:	Used to separate a named set from the named set value.	'\lvnc-sp:OPEN'
:=	Used to assign values. Step actions use this operator. The value of the right operand is assigned to the left operand.	'SP':='SFCCTRL:IDLE'
=	Used to compare values. Similar operators include >, <, >=, <=, != (not equal to), <> (not equal to). Transitions use these operators.	'SP'='SFCCTRL:START'
+	Used for addition of numeric values or for concatenation of strings.	
' '	Single quotes are used to enclose parameters.	
" "	Double quotes are used to enclose strings.	
;	Used to continue action statements on subsequent lines of the Expression Editor.	

## Parameter Tagnames

Parameter values are defined by their tagnames (tags, for short) in the form:

module/function block/parameter

When identifying parameter tags, you can build the tags from scratch by typing them in or you can use the parameter browser, which is a tool for searching the database.

---

## Interlock Conditions

In this procedure, we will use the Expression Editor to specify the interlock conditions on the three condition blocks.



### To specify the first interlock condition (the block valve is closed)

-  Click the Arrange Windows button on the toolbar (or select Window | Arrange Windows) so that you can see all the views again.
- Select the block named CND1.
- Click the right mouse button and select Expression from the menu to open the Expression Editor.
- Highlight and delete the default first line of FALSE.
- Click the Insert External Parameter button. This button browses for parameters that are external to the current parameter.  
The Browse dialog box opens.
- Double-click TANK-101.

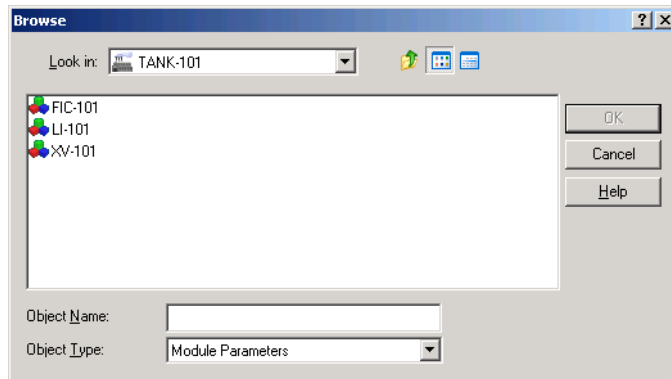

- Double-click these items in each succeeding level: XV-101, DC1, PV\_D and CV.  
The Expression Editor assembles the tagname and puts it in the Expression box.
- Click or type “=”.
- Click Insert Named State, browse for the named set vlvnc-pv, select the state CLOSED, and click OK.

10. Type a semicolon at the end of the expression.

The completed expression now reads as follows:

```
'//XV-101/DC1/PV_D.CV' = 'v1vnc-pv:CLOSED';
```

XV-101 is the module for the block valve; DC1 is the function block; PV\_D.CV is the current value for the process value; and CLOSED is one of the states in the named set, v1vnc-pv. The expression indicates that an interlock should occur (the motor should shut off) if the block valve is closed. (A named set is simply a way to define names and equate them to integer values. Named sets are defined in the DeltaV Explorer, under System Configuration | Setup.)

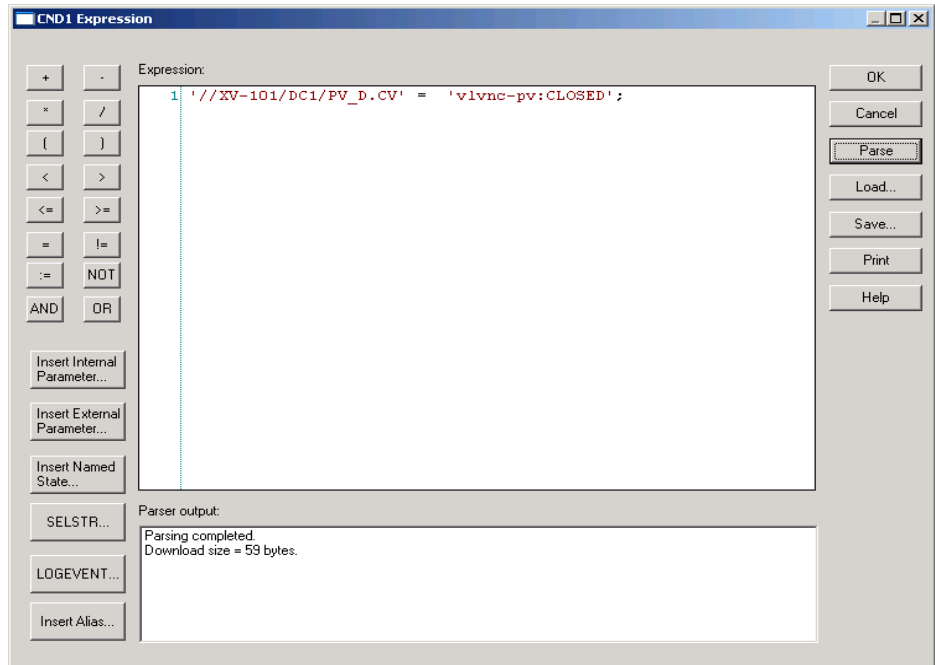

11. Click Parse.

The Expression Editor checks the syntax. If there are any errors, correct them.

12. Click OK.



### To specify the second condition

1. Select the CND2 block and use the Expression Editor to specify the interlock condition as:

```
'//LI-101/AI1/PV.CV' < 100;
```

LI-101 is the control module for the level indicator. AI1 is the analog input function block. PV.CV is the parameter for the analog input current value. The expression indicates that an interlock should occur (the motor should shut off) if the tank level goes below 100 gallons.

2. Click Parse, correct if necessary, and click OK.



### To specify the third condition (the regulatory valve is less than 5 percent open)

1. Select the CND3 block and use the Expression Editor to specify the interlock condition as:

```
'//FIC-101/PID1/PV.CV' < 5;
```

FIC-101 is the module for controlling the outlet flow (regulatory) valve. PID1 is the loop function block, and PV.CV is the parameter indicating the current state of the valve (percent open). The expression indicates that an interlock should occur if the valve is less than 5 percent open.

2. Parse the expression and click OK.



### To specify the DSTs for MTR-101

1. In the Function Block diagram, click the Device Control function block, DC1.
2. In the Parameter window, double-click the IO\_IN\_1 parameter. (This is the parameter for the run status signal.)
3. In the Properties dialog box, type XI-1 in the Device Tag field and click OK.

(If you have configured the controller and I/O channels, as described in Chapter 8, you can browse for the Device Tag under the controller.)

The parameter field is automatically set to the correct parameter, FIELD\_VAL\_D.

- 
4. Double-click the IO\_OUT\_1 parameter. (This is the output signal from the Discrete Loop block to the field device.)
  5. In the Properties dialog box, type ZX-1 in the Device Tag field and click OK. The parameter field is automatically set to OUT\_D.

## Finishing the MTR-101 Module



### To finish the module

1. Open the Properties dialog and set the Primary Control picture on the Displays tab to TANK101.  
  
Note that this module has two predefined pictures: DL\_DT8 for the Detail picture and DL\_FP for the Faceplate picture.
2. Change the Detail picture to DL\_DT3 to match the number of conditions.
3. Assign the control module to the controller.
4. Save the control module by clicking the Save button. (The module has already been named.)
5. Minimize Control Studio by clicking the Minimize button in the upper right corner.

## Exercise 8: Creating a Sequential Function Chart

Sequential Function Charts (SFCs) are types of module algorithms that are useful for controlling time-event sequences, such as startup or shutdown of a process. SFCs are made up of steps and transitions. Steps contain a set of actions. A transition allows a sequence to proceed from one step to the next when the transition condition is true.

Each time the SFC scans, the system evaluates the active steps and transitions. When a transition evaluates as True, the step prior to the transition is made inactive and the step following the transition becomes active.

There are no predefined module templates for SFCs since process sequences are highly individual. In defining an SFC, you may find it helpful to first define the steps in the process, and then identify the conditions that must be met before proceeding from step to step.



---

## The Sequence for the Tank Process

For the tank process, you will create an SFC to control the tank discharge. As a way to start and stop the SFC, you will create an SFC parameter called SP that the operator will be able to change. The SP will be manipulated with a named set called SFCCTRL. A named set defines names and equates them to integer values. For the tank example, you will create the named set with two values: 0=IDLE and 1=START.

Following is a suggested sequence for the tank discharge application.

Step 1: Stop (that is, set the SP to IDLE).

Transition: Wait for the user to change the SP to START.

Step 2: Put the flow loop in auto mode and set the setpoint to 50 gpm.

Transition: Wait for the regulatory valve to be 30% open.

Step 3: Open the block valve.

Transition: Confirm that the block valve is open.

Step 4: Start the pump.

Transition: Confirm that the pump has started.

First, you will create the named set, SFCCTRL, in the DeltaV Explorer. Then you will go to Control Studio to create the module containing the Sequential Function Chart.



### To create the named set

1. Open (or restore) the DeltaV Explorer.
2. Select System Configuration | Setup | Named Sets.
3. Point to Named Sets in the left pane, click the right mouse button and select New Named Set from the context menu.

A new entry, NamedSet $n$  (where  $n$  is the next number available), is added to the end of the list of existing named sets. The entry is in an edit box, ready to be renamed.

4. Type the new name, SFCCTRL, and press Enter.
5. Double-click SFCCTRL (or select SFCCTRL, click the right mouse button, and select Properties from the menu).

The Properties dialog box appears.

6. Type Sequence Control in the description box.

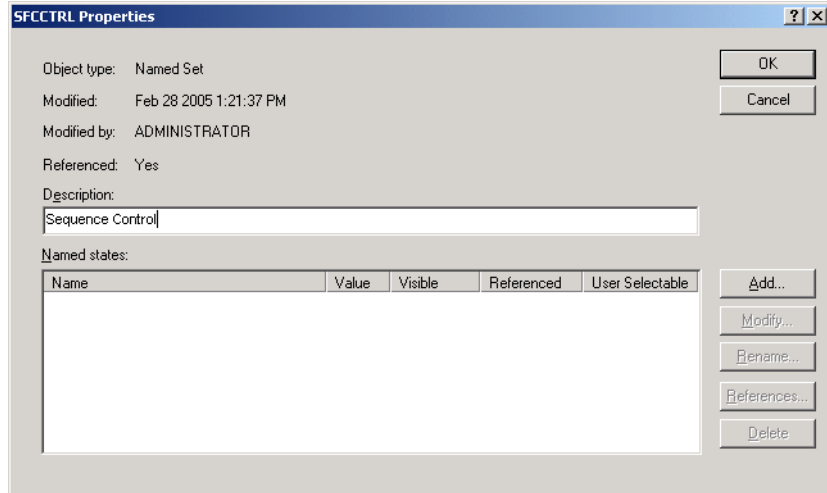

7. Click Add.

The State Properties dialog box appears.

8. Type IDLE in the Name box and click OK.

**Note**

*Named sets are case-sensitive. They may be defined using uppercase or lowercase characters, but all future references to the state must be as originally defined.*

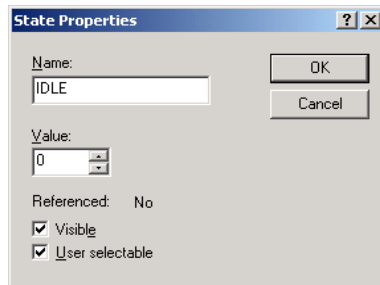

9. To add another state, click Add.

10. Type START in the Name box and click OK.

The Properties dialog box now has 2 named states, IDLE and START.

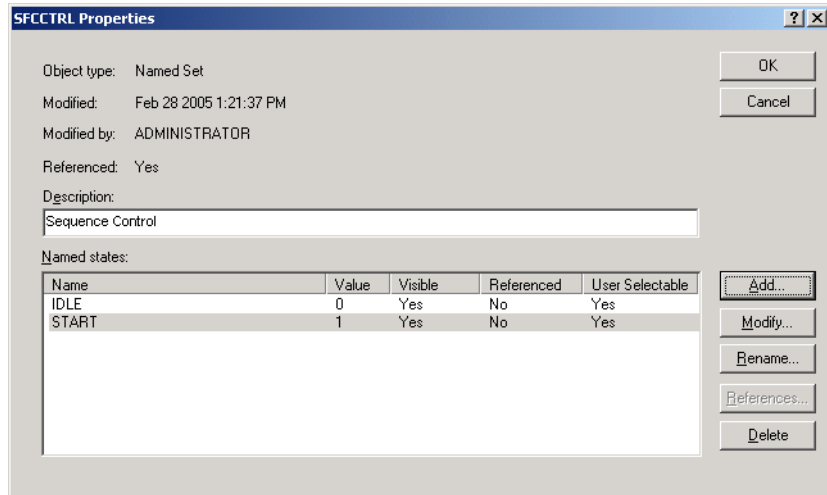

11. Click OK to save the set and close the dialog box.
12. Minimize the DeltaV Explorer.

## Creating the SFC Module

Now you are ready to create the Sequential Function Chart. Here are the things you will do in the following exercises:

- Create an SFC module.
- Add a parameter, SP, to the module to let the operator change the state from IDLE to START.
- Add the steps and transitions to the SFC.



### To create a Sequential Function Chart

1. Restore Control Studio by clicking its button on the Windows task bar.
2. Click File | New.
3. In the New dialog box, select Control Module or Template as the Object Type.
4. Select Sequential Function Chart as the Algorithm Type and click OK.

A new SFC diagram opens, with a single step, S1.

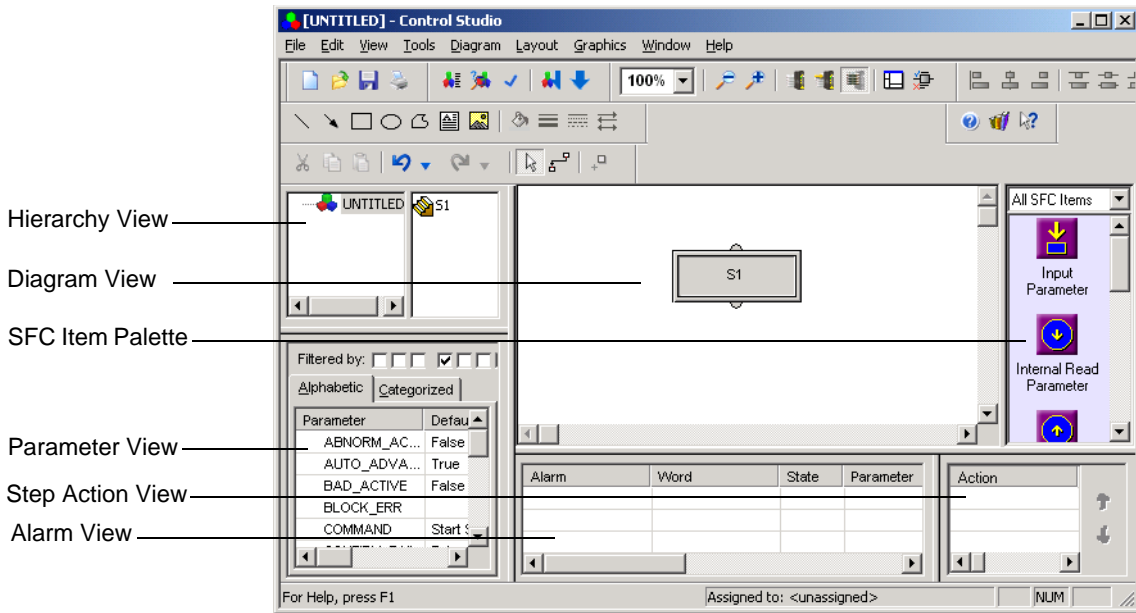

### To add the SP parameter

1. Click in the Parameter View, click the right mouse button, and select Add from the menu.  
The Properties dialog box appears.
2. Type SP as the Parameter Name.
3. Select Named Set as the Parameter type.
4. For the Named set and Named state, browse and select SFCCTRL | IDLE.

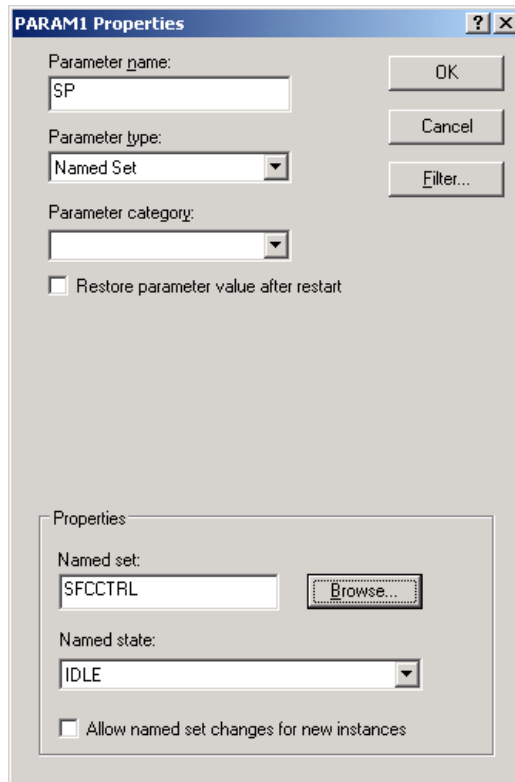

5. Click OK. The parameter is added to the module.



### To create a step action in the SFC

1. In the Diagram View, select the step box named S1.
2. Click the name, S1, and change it to STOP\_AND\_WAIT.
3. In the step Action View (in the lower right corner), click the right mouse button and select Add.

The Properties dialog box appears.

4. Enter the Step Description: Stop and Wait.
5. For the Action type, select Assignment. (This type assigns the result of an expression to a destination.)
6. For the Action qualifier, select Pulse.

---

A pulse action of any type means the action is only active on the first scan when the step goes active. Thus, the assignment statement is evaluated and the assignment made on the first scan through the step actions when the step goes active. After the first scan, the assignment destination retains the assigned value; it is not rewritten for each scan.

7. To set the setpoint to the IDLE state, type the Action expression:  
`'SP':='SFCCTRL:IDLE';` (Remember, named sets are case-sensitive.)

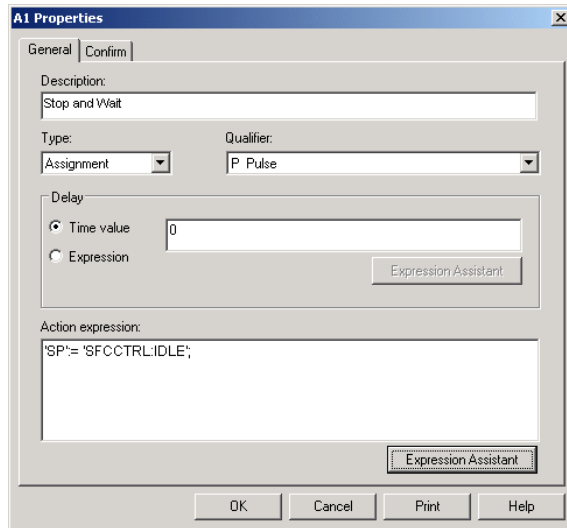

An alternative is to click the Expression Assistant button to open the Expression Editor to define the Action expression. (The Expression Editor was used earlier to define the interlock conditions for the motor control module.) Click the Insert Named State button in the Expression Editor to define the Action expression.

8. Click OK on the Properties dialog box. If necessary, make any corrections, and click OK.
9. Select the step action (A1) in the Step Action View, right-click and select Rename, and change the name to SET\_TO\_IDLE.

Giving the step actions meaningful names instead of A1, A2, etc., helps you identify a particular action you may want to modify.



## To create a transition in the SFC

-  From the palette of All SFC Items, click Transition, drag to a point below the box named STOP\_AND\_WAIT, and release the mouse button.  
A plus sign named T1 appears.
- Click the right mouse button and select Properties (or double-click the transition).  
The Properties dialog box appears.
- Enter the transition description (Wait until Start), open the Expression Assistant and build the condition statement:  
`'SP' = 'SFCCTRL:START'`

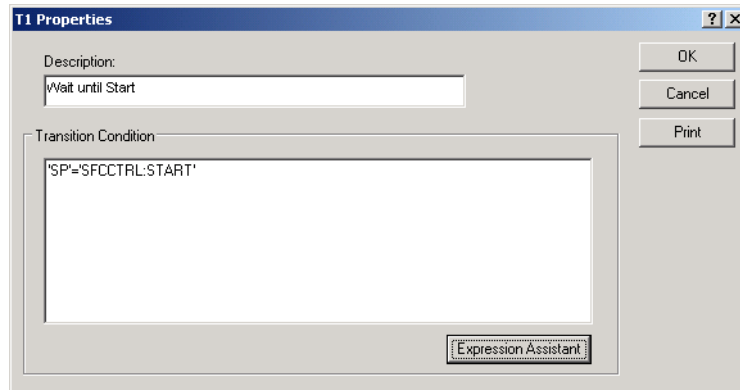

- Click Parse on the Expression Assistant. Correct, if necessary, and click OK on both dialogs.
- Rename the transition to WAIT\_UNTIL\_START.



### To complete the Sequential Function Chart diagram

1. Repeat the procedures for adding steps and transitions using the information in Table 4-2, which follows. (Drag-and-drop Step and Transition icons from the palette or use the Sequence item on the palette to automatically add multiple steps and transitions in one operation. Use a Termination icon for the last transition.)

#### **Tip**

*Select Tools | Diagram Preferences and check Display Grid and Snap to Grid to help you line up the SFC objects on the diagram.*

#### **Note**

*In the example, all Action Types are Assignment; all Action Qualifiers are Pulse, except for Action 2 in Step 2, which has an Action Qualifier of Non-stored. (The reason is that if Action 2 Step 2 were Pulse, it might not get set because it waits until the actual mode is Auto. It would fail on the first try and never be set.)*









2.  Use the Connect Mode tool to connect the steps and transitions in order.
3. Change the step and transition names by clicking the right mouse button, selecting Rename, and typing the Name listed in the table.



**Note**

Read the table footnote for important information about statement syntax.

Table 4-2 Actions and Transitions in the SFC

Step/Transition	Name	Action Text or Condition Text*	Description
 S1	STOP_AND_WAIT	'SP':='SFCCTRL:IDLE';	Inhibits startup sequence (until the user changes the SP to START).
 T1	WAIT_UNTIL_START	'SP':='SFCCTRL:START'	Waits until operator selects START. If SP is START, proceeds to the next step.
 S2	SET_FLOW_RATE	A1: '//FIC-101/PID1/MODE. TARGET':= AUTO;  A2: '//FIC-101/PID1/SP':=50; (Action Qualifier is Non-Stored.)	Sets the flow loop to AUTO.  Sets the setpoint at 50 GPM.
 T2	WAIT_FOR_OUT_30	'//FIC-101/PID1/OUT' > 30	Waits for the regulatory valve to be 30% open.
 S3	OPEN_BLK_VLV	'//XV-101/DC1/SP_D':=1;	Opens the block valve.
 T3	WAIT_VLV_OPEN	'//XV-101/DC1/PV_D'=1	Confirms that the block valve is open.
 S4	START_PUMP	'//MTR-101/DC1/SP_D':=1;	Starts the pump.
 T4	WAIT_PUMP_START	'//MTR-101/DC1/PV_D'=1	Confirms the pump started.
<p>* <b>IMPORTANT:</b> Step actions use a special assignment operator (:=) and end with a semicolon (;). Transitions use an equals sign (=) to indicate that when the condition is true, the next step should be made active. Parameter values are enclosed in single quotes.</p>			

---

The finished SFC looks like the following.

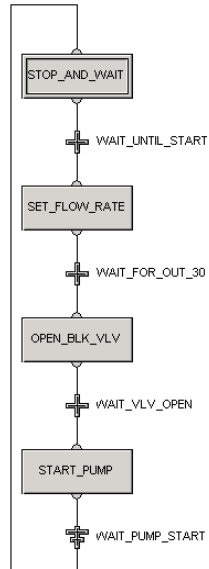

## Finishing the SFC Module



### To finish the SFC

1. Select File Properties and set the Primary Control picture to TANK101.
2. Click the Assign to Node button on the toolbar and assign the SFC module to the controller.
3. Click the Save button and save the SFC module as SFC-START.
4. Close Control Studio by clicking the close button in the upper right corner.

---

## Exercise 9: Downloading the Modules

Now that the control modules are all defined, you need to download the control strategy to the controller, assuming you have a controller configured. If you are working with a controller placeholder, you can assign the modules to the placeholder, but you cannot do a download.

There are several different levels of downloads. In the DeltaV Explorer, you can download:

- individual modules
- the controller node
- the control network, including the workstations and controllers

**Important** *If you are working on a system that is controlling a process, it is recommended that you do not perform any downloads for this tutorial unless you understand the impact of doing so.*

**Note** *You must load and assign the controller licenses before downloading the modules to the controller. Loading and assigning licenses is described in Chapter 8.*



### To download the modules

1. Open (or restore) the DeltaV Explorer and open System Configuration | Physical Network | Control Network | CTRL1 (or your controller name) | Assigned Modules. (This shows you all the modules you have assigned to the controller.)
2. Point to Control Network, click the right mouse button, and select Download | Control Network.

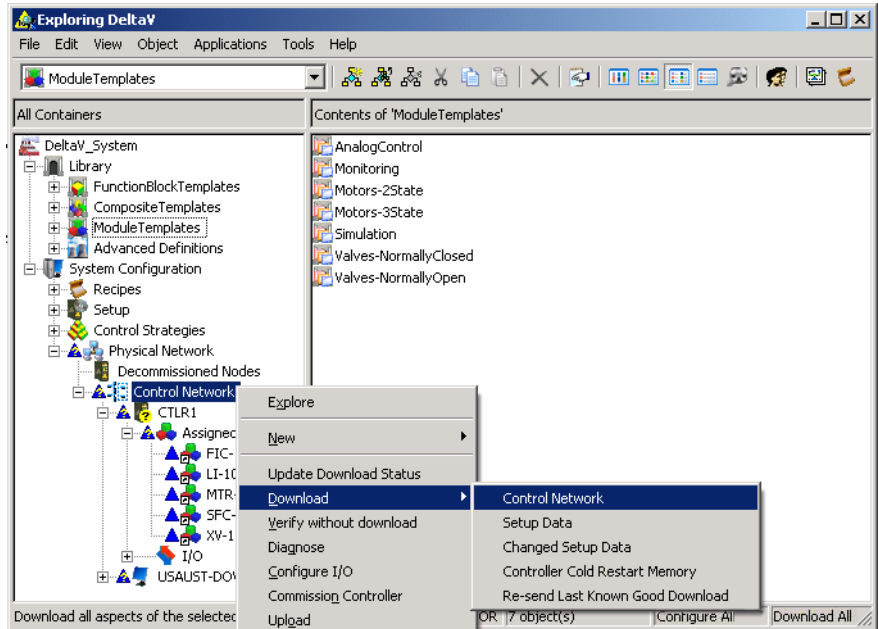

3. When asked, confirm that you want to proceed with the download.
4. When asked, confirm that you want to check the configuration.

A window opens to show you the progress of the download and to let you know when it is complete.

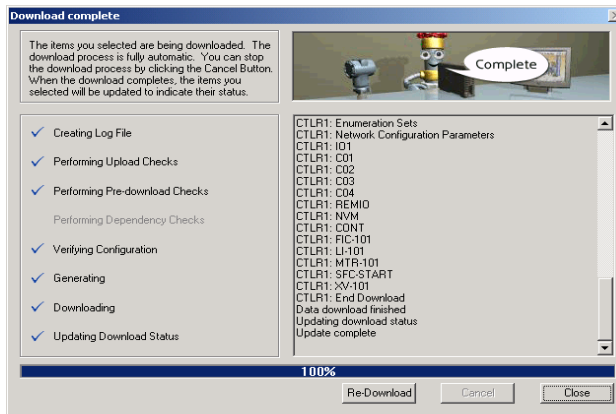

5. When the download is complete, click Close.
6. Close the DeltaV Explorer and any other DeltaV applications you have open.

---

## A Look Ahead

That's it for creating and downloading the control strategy. You have created the four control modules needed for the tank application and the sequential function chart module for automating the process.

In the next chapter you will learn about the DeltaV operating environment and how to create the operator pictures.



---

## Chapter 5    Creating Operator Pictures

In this section you will learn how to use DeltaV Operate in configure mode to create an operator picture (TANK101) for the example process system. Before creating process graphics, you need to understand some things about the DeltaV Operate application—to learn the importance of *designing for the operating environment*. Later you will see the finished picture from the operator’s point of view.

**Important**    *There are a few things you should know and a few rules that you must follow when designing operator pictures. Pay particular attention to the paragraphs marked Important.*

The DeltaV Operate application has extensive online documentation in the DeltaV Books Online. If you will be using this application, you will want to become familiar with the full range of features it provides. This tutorial only touches the surface.

One very helpful feature is the ability to toggle between the two DeltaV Operate modes: configure and run. While you are creating a picture in configure mode, you can preview the picture in run mode. This lets you test the elements of the picture, such as links and push buttons, as you create them.

### The DeltaV Operating Environment

It is important to understand the operating environment for a DeltaV process system before you start creating pictures to be used in that environment. The DeltaV Operate application functions in two modes:

- Configure mode — used to create pictures
- Run mode — used to run pictures in the DeltaV Operate application

Let’s start by taking a look at the standard DeltaV operator desktop, as seen in the DeltaV Operate application in run mode.

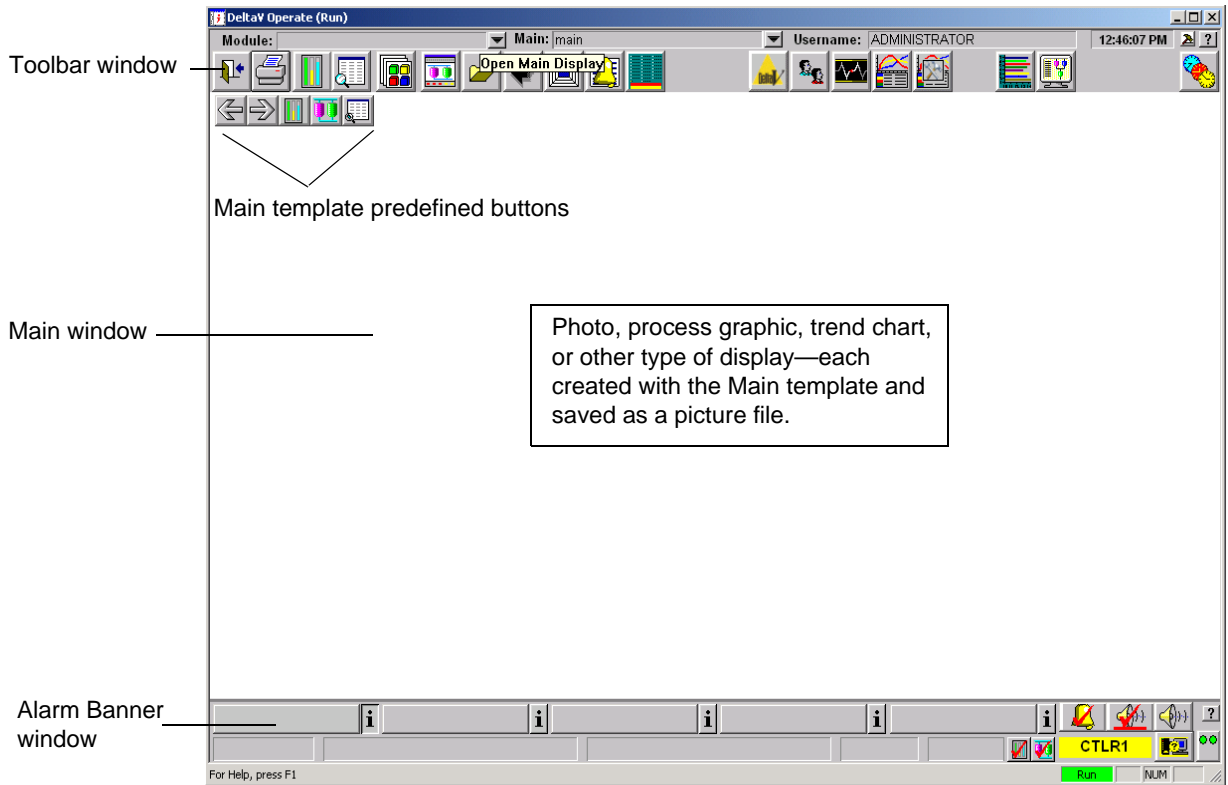

This desktop was designed specifically for use with DeltaV process systems. It is made up of three windows: the Toolbar window, the Main window, and the Alarm Banner window. The Toolbar buttons provide single-click access to important pictures, directories, and other applications.

**Important** *Although it is possible to add, modify, or delete buttons from the Toolbar and make other changes to the operator desktop, it is recommended that you do not do any customization until you are thoroughly familiar with the purpose and function of all its elements.*

The Alarm Banner at the bottom of the desktop also has important predefined functions. The five big buttons are used to notify the operator of the five highest priority alarms that have been activated. When an alarm is tripped, the name of the associated control module (such as XV-101) is displayed on one of the alarm buttons. By clicking one of these buttons, the operator goes directly to the appropriate process graphic for taking action on that alarm (the Primary Control picture and/or the Faceplate picture). The Alarm Banner also includes a node monitor button to let you monitor the current status of your controllers and workstations.



---

You may remember that we assigned a Primary Control picture to each control module as one of the finishing steps. For modules created from library templates, Faceplate pictures are predefined. A little later you will learn more about the Alarm Banner and how to acknowledge alarms.

The Main window is where the operator views a main picture, which is typically a process graphic that provides a view of the process or equipment. A main picture is any picture created using the Main template. The Main template has some predefined features, such as a small toolbar (with five buttons) in the upper left corner. The template also contains some picture commands that are required by the DeltaV environment.

Even in relatively small process systems, there are likely to be a number of main pictures. Each main picture is created and saved as a picture file with its own unique name.

**Important**

*The most important thing to remember about main pictures is that they must start from the predefined template named Main. Only subordinate pictures, such as pop-up messages to operators, should be created without using the Main template. If you create a new picture file from scratch or use a different template as a basis, much of the DeltaV Operate environment will not work.*

## Developing a Picture Hierarchy

A process application normally has a number of linked pictures, such as plant overview, process monitoring, system status, alarm summary, and trend pictures. There may also be pop-up windows for things like operator messages and help. Therefore, in addition to creating individual pictures, you will need to develop a system for linking pictures so that operators can easily get to the one they need.

## The Overview Picture and the UserSettings File

The DeltaV system starts you off with an Overview picture that you can tailor to fit your application. Generally, the Overview is used as the top level in the hierarchy. You can add pushbuttons to the Overview that let you link to other pictures. You can even use a photograph or drawing with hotspots (rather than pushbuttons) that link your Overview to other pictures.

The design of your Overview picture is limited only by your imagination. Here is an example:

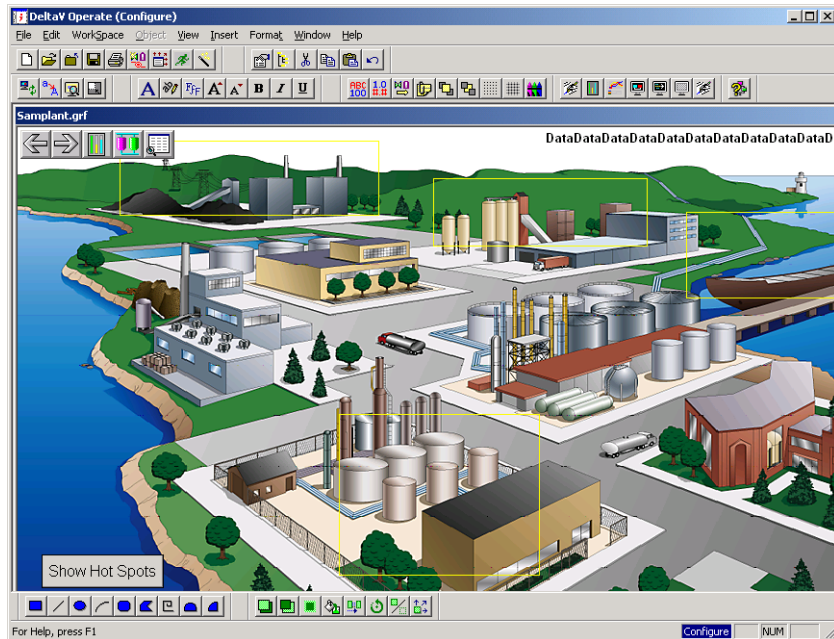

### **Important**



*The Overview picture has its own button on the Toolbar, so no matter how deep an operator gets into the hierarchy of pictures, it is always easy to get back to the Overview. This is one reason why you should put some thought into your Overview picture and how to make it useful for navigating to other important pictures.*



The Overview picture has initial text explaining how to rename the Overview picture by editing the file UserSettings (or User\_Ref) in the Standard folder in the system tree. This file is for advanced users who want to rename the Overview, set up the Display History List with a predefined list of pictures, modify or add global variables, and do other tasks that define the operator's startup environment. It is beyond the scope of this introductory manual to go into this in detail. To learn more about the UserSettings file and global variables, refer to Books Online.

---

## Navigating to Other Pictures

**Important** *When you set up navigational tools, the new picture should in most cases replace the current picture loaded in the Main window. The operator should not have more than one main picture open at a time.*

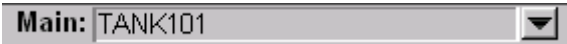
Here are some of the ways operators can move from one picture to another.

-  Each picture can have a Next Picture and Previous Picture defined for it. The operator can easily jump to those pictures using the forward and back arrows in the upper left corner of a picture created with the Main template.
-  The Main field above the tools on the Toolbar shows the name of the current main picture. The button next to the Main field opens a History List. Simply click a picture in the list to go to that picture. The list can be predefined and locked to show only a select group of pictures or it can be set up to act as a “most recently used” list that is updated with each new jump.
-  The operator can use the Open button to replace the current picture in the main window with the selected picture file.
- There can be buttons or other hotspots that activate a jump to a new graphic. The hotspot can be a word, an icon, a section of a photograph, or whatever you want to use as a visual clue to the jump’s destination.
-  The Alarm List picture is available through a Toolbar button.
- Clicking on an alarm button in the Alarm Banner immediately replaces the current main picture with the Primary Control picture for the module and pops up the Faceplate picture for the module indicated on the button.

---

## Switching Between Configure and Run Modes

We mentioned earlier that you can switch to run mode from configure mode. You do this by selecting **Workspace | Switch to Run** or pressing **Ctrl/W**. (To return to configure mode, click the right mouse button and select **Quick Edit** or press **Ctrl/W**.)

The appearance of the DeltaV Operate window in run mode is dependent upon settings that you make in configure mode. There are security settings that allow you to secure the run-time environment and choose the specific actions that you want to restrict. For example, you can restrict the operator from closing the current picture and switching to another application. Click **Workspace | User Preferences** and select the **Environment Protection** tab. Select the **Enable Environment Protection** checkbox and then select the options that you want to enable.



There are DeltaV User settings that allow you to control how DeltaV Operate opens in run mode. Click the **DeltaV User Settings** button on the toolbar to access these settings. Experiment with these settings and refer to the online help and to Books Online for more information.

So, for now, when you switch to run mode, do not be concerned if your pictures do not look exactly like the images in this chapter.

---

# Getting Started with DeltaV Operate (Configure Mode)

Let's get started now with DeltaV Operate in configure mode.



## To launch DeltaV Operate in configure mode

1. Click Start | All Programs | DeltaV | Engineering | DeltaV Operate Configure.

### Note

*You can Press Ctrl+W or select Workspace | Switch to Run to switch to Operate run mode. To return to configure mode, press Ctrl+W or right-click and select Quick Edit.*

### Note

*The User Preferences dialog (accessed by clicking Workspace | User Preferences) provides means to define the DeltaV Operate start environment. To ensure security in your plant, it is very important that you carefully develop your security scheme before making changes to the start environment. Refer to the online help and Books Online for more information before making changes to the User Preferences dialog.*

DeltaV Operate (in configure mode) opens with a blank drawing. In addition to the menu bar and toolbars, the window is made up of a system tree and the work area.

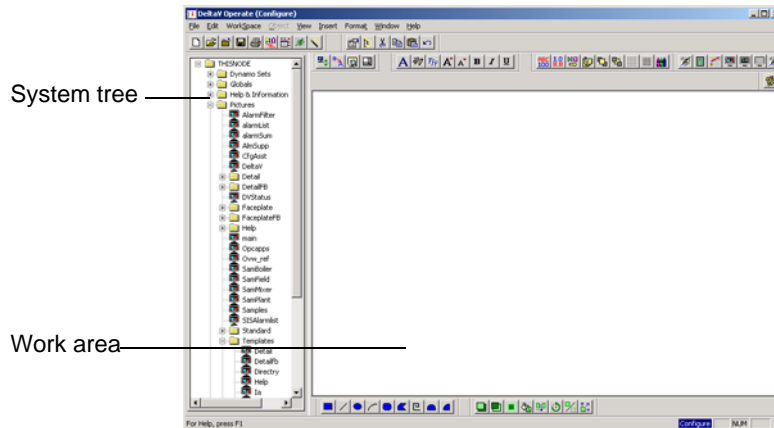

The system tree shows a hierarchical view of the files on the local node and all objects associated with each file. The system tree can be resized, moved, or hidden. Opening and closing folders in the system tree is the same as opening and closing folders in the Windows Explorer: click a plus sign (+) to open a folder and see its contents; click a minus sign (-) to close a folder and hide its contents.

---

Take a few minutes now to become familiar with the system tree. Open a folder and double-click on a file to open the file in the work area. Click the plus sign (+) next to the file and select an object associated with the file. Notice how that object is highlighted on the picture in the work area. Select File | Close to close the file or click the right-mouse button and select Close. Continue to explore the system tree, and when you ready, continue to the next section.



### **To open the Main template**

1. In the system tree, click the plus signs next to the Pictures folder to expand its contents, and then click the plus sign next to the Templates folder to expand its contents.
2. Double-click the Main template picture.

The Main template and the Toolbox open in the Work Area. (If the Toolbox is not visible, select Toolbars from the Workspace menu, select Picture as the toolbox owner, and then click DeltaV\_Toolbox.) Notice how a plus sign appears next to the Main picture. Click the plus signs to see the objects that make up the Main template. The Main template has instructional text, including a description of the five buttons in the upper left corner. In your system, the background color may be gray rather than white, as shown in this document. Later, we will tell you how to change picture background color, as well as object colors.

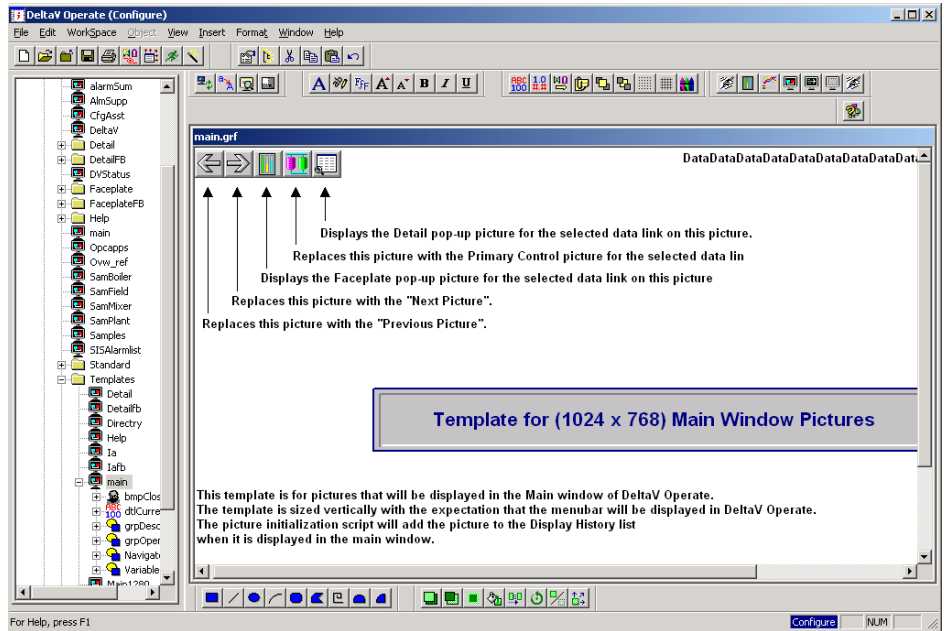

3. Read the information on this template. Then delete the text by clicking in the center of the page, clicking the right mouse button, and selecting Delete (or pressing the Delete key).
4. Select File | Save As. The Save As dialog box appears.
5. Click the Up One Level button to go to the Pic folder.

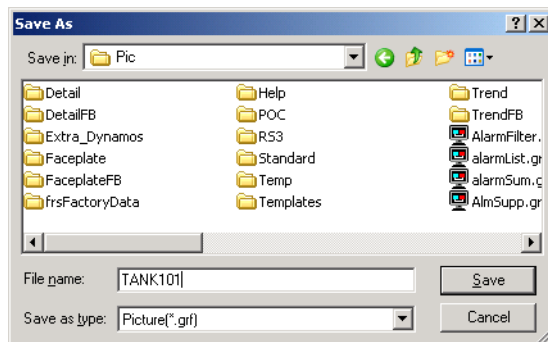

6. Enter the File Name as TANK101 and click Save. (Be sure the picture is saved in the Pic folder.)

---

**Note**

*Picture file names must be alphanumeric and cannot contain the hyphen character, begin with a number, or use a Visual Basic reserved word.*

## Toolbars and the Toolbox



Toolbars contain buttons that provide shortcuts to menu commands. For example, instead of selecting File | Save, you can click the Save Picture button on the Toolbar. Buttons that perform similar functions are grouped into separate toolbars. For example, the standard toolbar usually contains the Open, Close, Save, and Print buttons.

Toolbars are owned by the WorkSpace or by Picture. The toolbar's owner defines when the toolbar appears. For instance, WorkSpace toolbars appear when the WorkSpace runs, Picture toolbars appear only when one or more pictures are displayed.

**Note**

*Picture toolbars are assigned to all pictures. You cannot assign toolbars to specific pictures.*



### To see the Toolbars

1. Click Workspace | Toolbars.

The Toolbars dialog box appears. By default the Workspace toolbars are displayed.

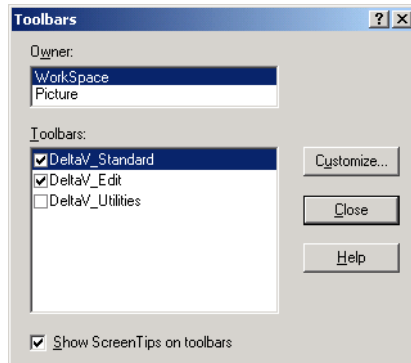

2. Make sure that Show Screen Tips on toolbars in the lower left corner is selected.

With Screen Tips enabled, when you pause the pointer over a tool in the Toolbox, its name will pop up.



- 
3. Uncheck and recheck the various toolbars to see the buttons that belong to each toolbar. (Watch the toolbar across the top of the window and see which buttons disappear and then reappear.)

4. Click the Customize button and use the online help to familiarize yourself with the Customize Toolbars dialog.

Click the Help button for overall help on the dialog. For help on individual fields in the dialog, click , then click on the field for which you want help.

Later, when you are more familiar with the tools, you can add and remove buttons and toolbars to suit your needs.

5. Click Close on the Customize Toolbar dialog box.
6. Click Workspace | Toolbars to reopen the Toolbars dialog and select Picture in the owner field.
7. Select the DeltaV\_Toolbox if it is not already selected.

DeltaV\_Toolbox is a group of toolbars assembled in one dialog. It saves space on your picture because you do not have to keep several toolbars open. By default, docking is not enabled for the DeltaV\_Toolbox and it floats regardless of its position on the screen. The DeltaV\_Toolbox contains everything from simple drawing tools for creating lines, rectangles, and circles to complex charting tools.

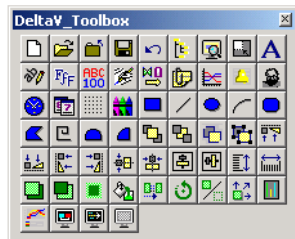

8. In the Toolbars dialog, select DeltaV\_Operating\_Experts, if it is not already selected.
9. Click Close on the Toolbars dialog box.

You can hide the Toolbox by selecting its title bar, clicking the right mouse button, and selecting Hide. You can move and resize the Toolbox and enable docking.



### **To move and resize the Toolbox**

1. Click the Toolbox title bar, hold the mouse button down, drag to a new location, and release the mouse button.
2. Point to any corner or side of the Toolbox. The pointer changes to a two-sided arrow.
3. Hold the mouse button down and drag to reshape the box.
4. Release the mouse button when the Toolbox is in the desired shape.
5. Repeat the moving and resizing steps as needed to suit your personal preferences.



### **To enable docking**

1. Click Workspace | Toolbars.
2. Click Picture and click the Customize button.
3. Select DeltaV\_Toolbox.
4. Select Enable docking for selected toolbar and click Close.
5. Move the toolbox to the top edge of the screen and notice how the toolbox “docks” to the edge rather than floats over the screen.
6. Disable or enable docking to suit your personal preferences.

## **Color**

You can use color in two ways:

1. Adding foreground, background, or edge color to a selected object.
2. Adding color to more than one object.



To add color to a selected object, select the object, click the right mouse button, choose Color, and then select Foreground, Background, or Edge. Once you select a color, click OK, and close the dialog box. To add color to multiple objects, select the Color button on the Toolbox. The Color dialog box stays on your screen as you select colors. For the exercises in this book, we will use the first method.

---

The Color Selection dialog box contains two tabs that let you choose the color from a palette or from a list of names. You select a color by clicking the color in the palette or selecting a color from the list.

Default colors appear in the Shape Preferences tab of the User Preferences dialog box. To change the default colors, click **Workspace | User Preferences | Shape Preferences**, and then click the color box that you want to change (Foreground, Background, or Edge) and select the new default color from the palette.

**Note** *Changes to the default colors do not change the colors of objects that are already in the picture.*

**Tip** *To change the background color of the entire picture, click **Edit | Picture**, click in the **Background Color** box, and a color palette appears from which you can select a background color. Click **OK** to return to the picture and display the new background color.*

## Line Styles and Fill Styles

You can also change the default line styles, widths, and fill styles using a procedure similar to that for changing color defaults. To change the default edge styles, width, and fill, click **Workspace | User Preferences | Shape Preferences**, and then edit the default item that you want to change.

You may want to take a few minutes to experiment with drawing basic shapes and changing the foreground, background, and edge colors. To get started, use the following procedure.



### **To draw and color a rectangle with a crosshatch appearance**

1. Click the rectangle button on the Toolbox. The pointer changes to a +.
2. Hold down the mouse button, drag the pointer to set the desired size, and release the mouse button to place a rectangle on the picture.
3. Select the rectangle, click the right mouse button and select **Fill Style | Cross Hatch**.  
For the remaining steps, make sure the rectangle is selected.
4. Click the right mouse button, select **Edge Style | Dash Dot**.
5. Click the right mouse button, select **Color | Foreground** and select yellow in the palette.

- 
6. Draw another rectangle. Note that none of the default colors, line style, or fill style have changed.

Now you can add some basic shapes and text to your drawing using the rectangle, oval, line, polyline, polygon, and text tools. Try coloring, moving, and resizing the objects. (If you use the polyline or polygon tools, double-click to finish the object.) When you have finished, click File | Close and do not save the work you have done on the file.

If you are ready to continue, open TANK101 from the Pictures folder in the system tree.

## Links, Dynamic Properties, and Parameter References

*Links* allow you to display real-time and system data in the DeltaV Operate application in run mode. There are several different types of links. The links introduced in this tutorial are datalinks and trend links.

In configure mode, *properties* are parameters of objects that you can alter using tools, menu commands, and dialog boxes. *Dynamic properties* are object parameters that change in DeltaV Operate run mode based primarily on changes in database values. (For example, a tank may change color as it fills, that is, as the current value of the level indicator changes.)

A *parameter reference* identifies the database field that supplies data to a link or dynamic property. The parameter reference syntax is

node:tag.field

where *tag* is usually in the form: module/function block/parameter.

For example,

DVSYST.FIC-101/PID1/SP.F\_CV

is the parameter reference identifying the current value of the setpoint field (parameter) in the PID1 function block of the FIC-101 control module.

If you enter only the tag (for example, FIC-101/PID1/SP), DeltaV Operate fills in the default node of DVSYST and uses a default current value field of either F\_CV (floating point current value) or A\_CV (ASCII current value), based on the type of data (Numeric or Text) you specify for the link. If the tag does not exist, you are asked if you want to use it anyway.

... In most dialog boxes that require entry of a parameter reference, a browser is available to help you search through the network for a particular parameter reference. To access the browser, click the ellipsis button next to the Source field to access the Browse dialog box.

The Data Source Browser from the Expression Builder box appears first. Then the Browse dialog appears after you select Browse DeltaV Control Parameters. (The first time the parameter browser is called, it may take a few seconds for the Browse dialog to appear.)

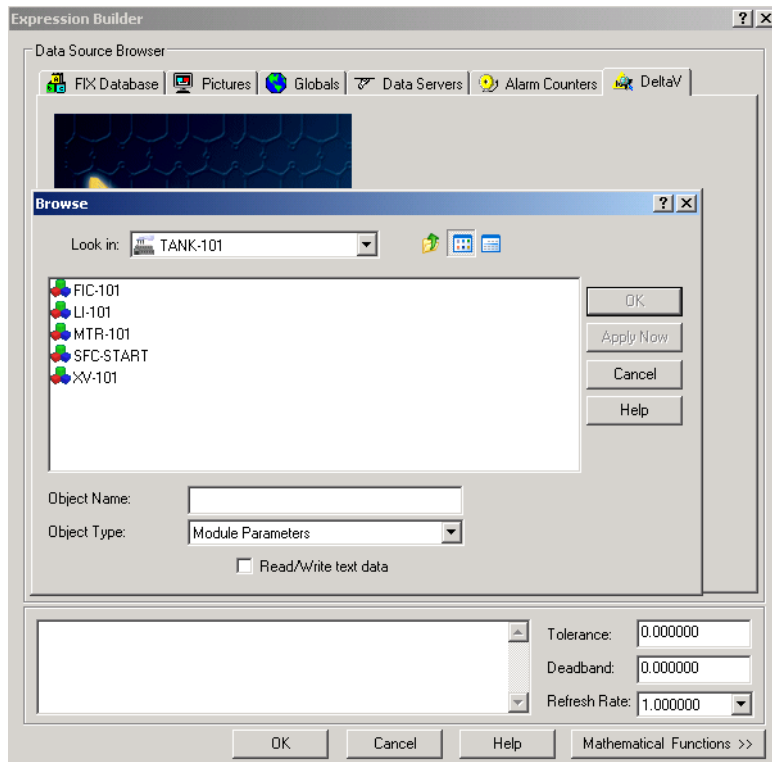

---

## Creating Datalinks

Datalinks can be used to display data as numbers or text. For the TANK101 picture, you will create five datalinks for the following purposes:

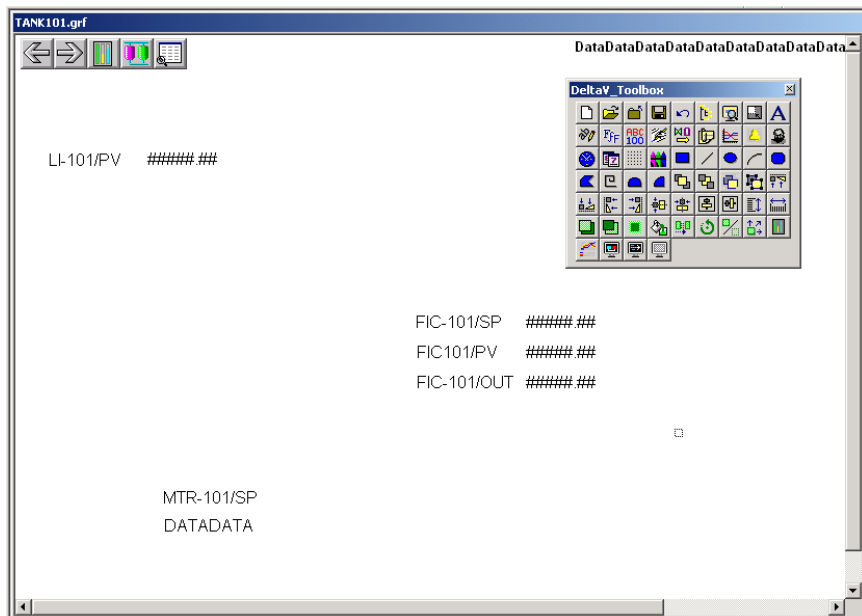

- To display the current value of the tank level (parameter reference: LI-101/AI/PV)
- To display the current value of the loop process value (parameter reference: FIC-101/PID1/PV)
- To allow entry of a setpoint value for the flow loop (parameter reference: FIC-101/PID1/SP)
- To allow the operator to set the regulatory valve position (parameter reference: FIC-101/OUT)
- To allow the operator to start and stop the pump motor (parameter reference: MTR-101/DC1/SP\_D)

After you have created the links, your working area will look like this:





## To create a datalink for the tank level

-  Click the Datalink Stamped button in the Toolbox.  
The Datalink dialog box appears.
-  To search for the parameter reference, click the ellipsis button.

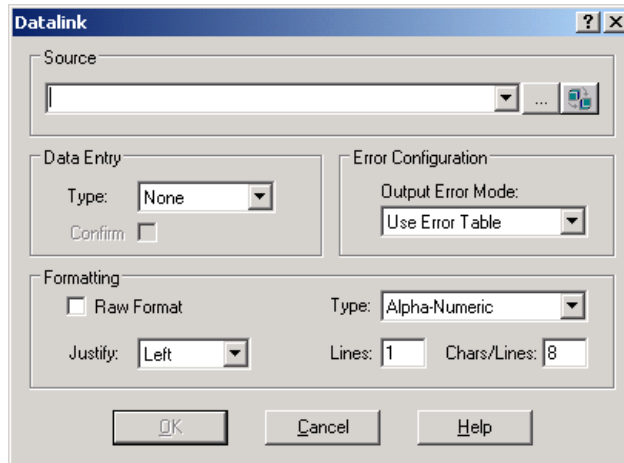

The Expression Builder dialog box appears.

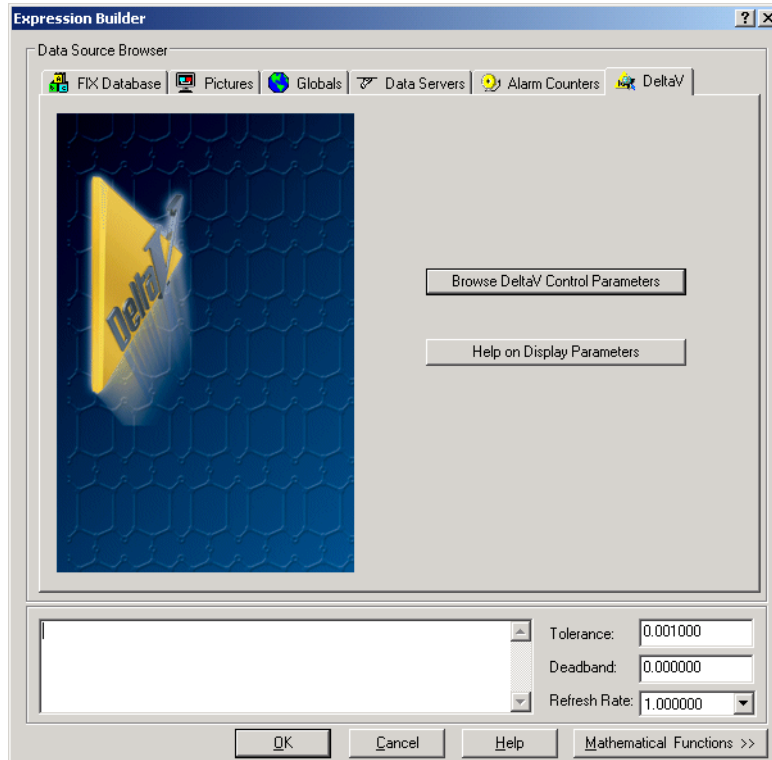

3. Select Browse DeltaV Control Parameters to open the Browse dialog box. (This may take a few seconds.)
4. If TANK-101 is not displayed in the Look in: field, click the Up One Level button to go to Control Strategies, and then double-click the TANK-101 area.



The Up One Level button can be used to move up one level in the hierarchy. The contents of the selected level are displayed in the list box.

A list of the modules assigned to the TANK-101 area is displayed.



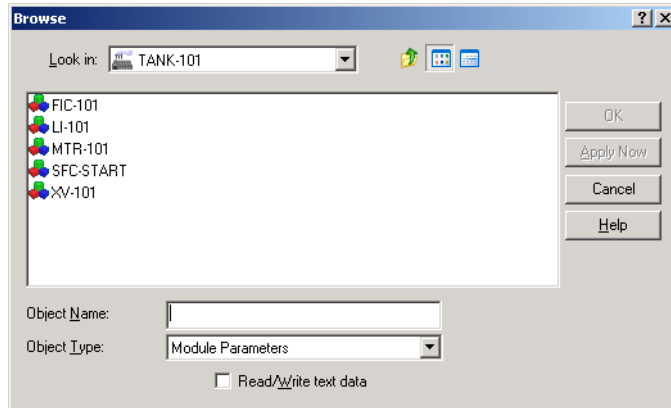

5. Double-click the module name, LI-101. A list of function blocks and module-level parameters is displayed.
6. Double-click the AI1 function block. A list of parameters is displayed for that function block.
7. Double-click the PV parameter. A list of fields is displayed.
8. Click the CV (current value) field, then click OK. (Or, simply double-click the CV field.)

DeltaV Operate assembles the node, tag, and field information and enters it into the Expression Builder dialog box.

9. Click OK to return to the Datalink dialog box.
10. Click OK in the Datalink dialog box.

### Note

*The DeltaV Operate application reads the datalink and automatically configures the settings in the Datalink dialog box based on the datalink.*

The stamper and datalink appear and “float” on the picture.

11. Click the mouse button in the upper left quadrant to place the datalink on the picture. (See the TANK-101 picture under Creating Datalinks for the approximate location.)

The datalink appears on the picture as #####.##, surrounded by handles.

(If you have not gone through the exercise of installing the module to a controller, you may get a message about the parameter reference not existing. You can select “Use Anyway” to be able to use this parameter reference for the tutorial.)

- 
-  To label the datalink, click the Text button in the tool box, click to the left of the datalink, and type LI-101/PV.

 After clicking the text tool the pointer remains in text mode. Click the mouse to change it back to an arrow pointer.

**Tip**

*To move any object, you can select it and drag it to a new location. You can use the alignment tools to align objects horizontally and vertically. You can also use the arrow keys on the keyboard to make minor adjustments in the position of any selected object.*



**To create a datalink for the loop setpoint**

- Click the Datalink Stamper button.
- Type in the new parameter reference as FIC-101/PID1/SP.



If you use the Parameter Browser, click the Up One Level button to go up to the module level.

The system changes the parameter reference to DVSYS.FIC-101/PID1/SP.F\_CV. The default node for all parameter references is DVSYS.

- Select In-Place in the Data Entry Type field. (This allows operators to change the value.)

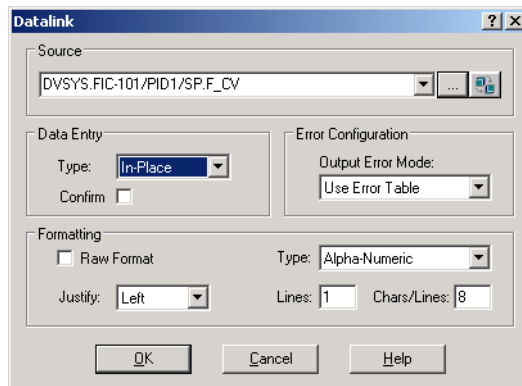

The screenshot shows a dialog box titled "Datalink" with the following fields and options:

- Source:** A text field containing "DVSYS.FIC-101/PID1/SP.F\_CV".
- Data Entry:** A section with a "Type" dropdown menu set to "In-Place" and a "Confirm" checkbox which is unchecked.
- Error Configuration:** A section with an "Output Error Mode" dropdown menu set to "Use Error Table".
- Formatting:** A section with a "Raw Format" checkbox (unchecked), a "Type" dropdown menu set to "Alpha-Numeric", a "Justify" dropdown menu set to "Left", and two input fields: "Lines" set to "1" and "Chars/Lines" set to "8".

At the bottom of the dialog are three buttons: "OK", "Cancel", and "Help".

- Click OK.

**Tip**

*If you accidentally close the Datalink dialog box before completing your selections, double-click the link to reopen the dialog.*

- 
5. Place the datalink in the lower right quadrant of the screen.
  6. Use the Text button to add this label: FIC-101/SP.



#### **To create a datalink for the loop process value**

1. Click the Datalink Stamper button. (This datalink will be placed below the loop setpoint.)
2. Edit the parameter reference to be FIC-101/PID1/PV.F\_CV.
3. Click OK.
4. Place the new datalink below the loop setpoint.
5. Use the Text button to add this label: FIC-101/PV.



#### **To create a datalink for the loop output**

1. Click the Datalink Stamper button. (This datalink will be placed below the loop process value.)
2. Edit the parameter reference to be FIC-101/PID1/OUT.F\_CV.
3. Select In-Place and click OK to let the application configure the fields in the dialog.
4.  Select the datalink and click the DeltaV Data Entry Expert button on the Toolbox.
5. Be sure that Numeric Entry is selected and click Fetch Limits from the Data Source.
6. Click OK.
7. Place the datalink below the loop process value.
8. Use the Text button to add this label: FIC-101/OUT.



### To create a datalink for the motor setpoint

1. Click the Datalink Stamper button. (This datalink will be placed in the bottom left quadrant.)
2. Fill in the parameter reference as MTR-101/DC1/SP\_D. A\_CV.

If you browse for the parameter reference, the system will automatically supply .F (for floating point) after SP\_D. Edit the parameter reference to have .A\_CV (for ASCII) after SP\_D.

**Tip** *Select the check box Read/Write text data in the Browse dialog box to make the default datalink A\_CV.*

3. In the Datalink dialog box, select None in the Type section and click OK to let the application configure the remaining fields in the dialog.
4. Click the mouse to place the new datalink in the bottom left quadrant.
5.  Select the datalink and click the Data Entry Expert button on the Toolbox.
6. Click Pushbutton in the Entry Method section.
7. Type STOP in the Open Button Title(0) field.
8. Type START in the Close Button Title(1) field.

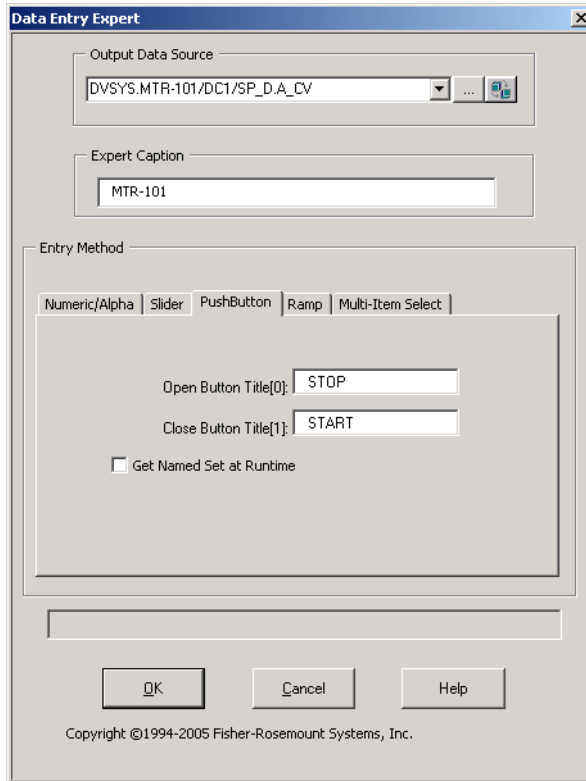

This data entry method lets you create a Stop and Start pushbutton for the operators. By clicking on the datalink on the picture, the operator can start and stop the pump motor.

9. Click OK.
10. Reposition the new datalink, if necessary, in the bottom left quadrant.
11. Use the Text tool to add this label: MTR-101/SP.
12. Select File | Close and save and close the picture.

**Note**

*It is a good idea to save your picture file any time you do a significant amount of work on it.*

---

# Switching to DeltaV Operate in Run Mode

Let's take a quick look at the picture in DeltaV Operate run mode.



## To switch to run mode

1. Click Workspace | Switch to Run or press Ctrl+W.
2.  Click the Open Main Display button and select TANK101.

If you have a controller, the datalinks will show as numbers. The numbers will not be realistic because we do not have any real I/O devices configured. If you have a placeholder for a controller, the numeric datalinks will show as question marks.

3. Return to configure mode by clicking the right mouse button and selecting Quick Edit.

Either close the DeltaV Operate application (by clicking the Close button in the upper right corner) or continue with the next exercise.

## Dynamos

As you develop a system of operator pictures, you may need to use an object (such as a pipe, pump, or valve) in more than one picture. You can save such custom built objects as reusable graphics called *dynamos*. If you assign dynamic properties to an object, those properties are retained when you save it as a dynamo.

In configure mode, DeltaV Operate provides prebuilt dynamo sets containing common process control objects, such as pumps, that you can paste into your pictures rather than drawing them yourself. You can modify an existing dynamo and save it in the original set or in a new set. You will likely want to save your most used dynamos in your own dynamo sets.

To complete the Tank101 process picture, you will use several different dynamos and modify their dynamic properties. Following is a brief summary of what you will do in the next few exercises.

- Add a pump dynamo and animate the color. It will change from red to green to signal the pump going from off to on.
- Add a tank dynamo with dynamic properties. The tank level will change to show the gradual discharge of its contents.
- Add a block valve and regulatory valve. The valves will change color to show their state (closed or open).

- Add pipes to connect the other objects. These could also be made to change color, but you will not assign dynamic properties in the example.

The picture will look something like the following figure. Use this as a guideline for placing objects on your picture.

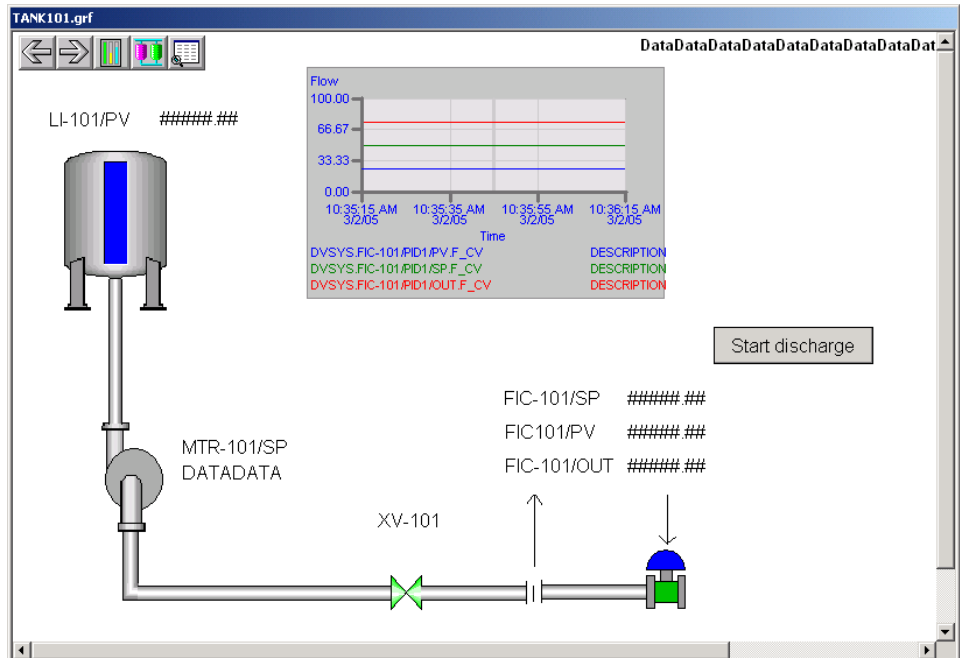

---

## Creating a Pump Using a Dynamo

(If DeltaV Operate is not open, open it in configure mode, expand the Pictures folder in the system tree, and double-click the tank picture file, TANK101.)



### To open the pump dynamo set and paste a dynamo on your picture

1. From the system tree in configure mode, expand the Dynamo Sets folder, and double click PumpsAnim.

The dynamo set opens at the bottom of your screen.

2. Back in the system tree, expand the PumpsAnim folder, and select PumpsAnimVertA1.

The dynamo PumpsAnimVertA1 is highlighted in the Dynamo Set at the bottom the screen.

3. Select PumpsAnimVertA1 and drag it onto the picture. (Alternatively, you can drag the dynamo name from the system tree onto the picture.)

Because this dynamo has animation properties, you are asked if you want to animate the pump color.

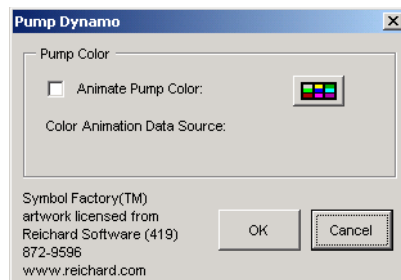

We will animate the pump color so it changes from red to green when the pump goes from Stop to Start.

4. Select the check box Animate Pump Color.

The Color By dialog opens.

5. Browse for MTR-101/DC1/SP\_D/CV as the digital tag for the pump.

6. Select Exact Match.

7. Click the Delete Row button and delete all but two rows.



8. Set the value in the first row to 0.00, click the color bar, and select red.
9. Set the value in the second row to 1.00, click the color bar, and select green.

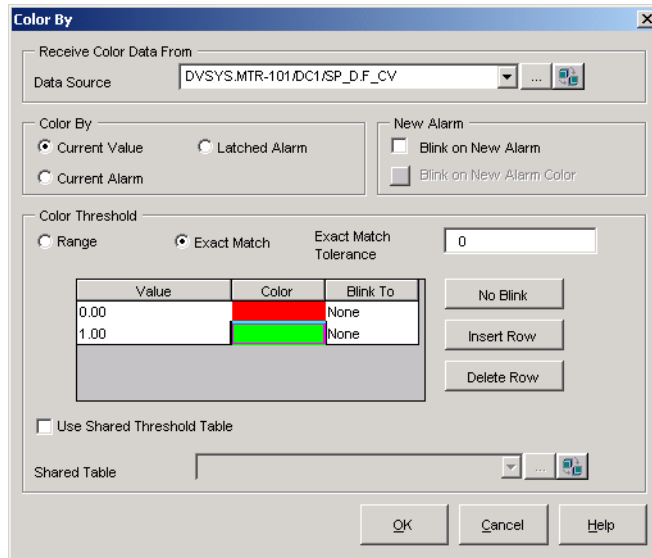

10. Click OK on both dialog boxes.

The pump is placed on the picture.

## Creating a Tank Using a Dynamo

Now you will add a tank that, in run mode, is supposed to show the level of the product in the tank by changing color. (This will not actually happen, since we do not have a working system with I/O.)



### To create the tank using a dynamo

1. First, close the PumpsAnim dynamo set by selecting PumpsAnim in the system tree, clicking the right mouse button, and selecting Close.
2. Double-click the TanksAnim1 dynamo set in the system tree to open the dynamo set.
3. Drag the tank labeled TankWDoorD1 to your picture, placing it a little above the motor, as in the figure shown earlier.

4. On the Tank Dynamo dialog box, browse for the following tag for the tank level.  
LI-101/AI1/PV/CV

The system automatically adds .F\_CV as the field.

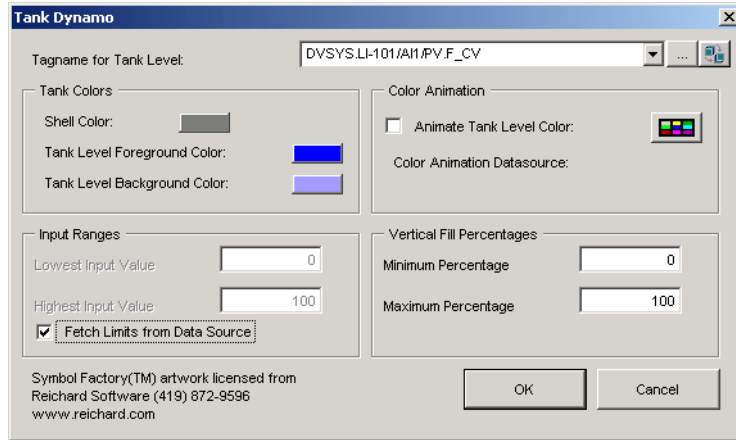

5. Select Fetch Limits from Data Source.
6. Click OK.  
The tank is placed on the picture.
7. Close the TanksAnim1 dynamo set.

## Finishing the Process Picture

For other parts of the picture, use the dynamos in the following table and arrange them as shown in the earlier illustration of the process graphic. Be sure to read the table footnotes for the block valve and regulatory valve. If you have forgotten how to animate the color for the regulatory valve, refer to the procedure for animating the pump on page 5-26.

Item	Parameter Reference for Dynamic Properties	Dynamo Set	Dynamo
Pipes	no dynamic properties	Pipes	As needed
Block valve	XV-101/DC1/PV_D/CV	ValvesAnim	ValveHorizontalAnim1 <sup>a</sup>
Regulatory Valve	FIC-101/PID1/PV/CV	ValvesAnim	ValveHorizontalControl1 <sup>b</sup>

a. Accept the defaults in the Valve Dynamo dialog box.

b. In the Valve Dynamo dialog box, choose Animate Valve Color. In the Color By dialog box, choose Color by Current Value. Under the Color Threshold, select Range and set the colors as follows: 0-50 is red; 50-100 is green.

A pipe can be lengthened or widened by selecting the pipe, dragging one of its resizing handles, and releasing the mouse button. In fact, any of the graphic objects, including text, can be resized and reshaped by dragging the side or corner handles.

The following procedure shows a suggested order for creating the objects. You can create them in any order you want.



#### To add the remaining dynamos

1. Add the vertical pipe to connect the tank and motor. Add an elbow pipe section to connect the motor to the horizontal pipe. Move and resize objects as necessary.
2. Add the block valve (for XV-101) according to the information in the table.
3. Add a pipe to connect the pump and block valve.
4. Add the regulatory valve for the control loop (FIC-101).
5. Add two sections of pipe between the block valve and regulatory valve by copying and pasting (or duplicating) the existing section of horizontal pipe. Click the right mouse button and use the context menu to select your editing choices.
6. Using the Line tool, draw short vertical lines to indicate the orifice plate measuring the flow.
7. Rearrange your datalinks so that your picture now looks like the illustration shown earlier. Add text labels as shown.



---

## Trend Links

Trend links are used to provide real-time trend charts in run mode. The links can use trend data from any floating point database field (.F\_). You add charts by selecting the chart tool from the Toolbox. The chart tool gives you control over the layout, pen color definition, and so on.



### To add a 3-pen chart

-  Click the Chart button on the Toolbox and move the cursor onto the picture.  
The cursor turns into a cross-hair.
- Click the mouse and drag it to form a rectangle. (Refer to the illustration of the process graphic to size the rectangle.)
- Release the mouse button to place the chart on the picture.
- Select the chart and move it to the upper right corner of your working area.
- Select the chart, click the right mouse button, and select Chart Configuration.
- Click the Chart tab, click in the Pen List area, and delete the sample pen displayed there.
-  Click the Add Pen button and then click the ellipsis button and configure the three pens with the following parameter paths:  
DVSYS.FIC-101/PID1/PV.F\_CV  
DVSYS.FIC-101/PID1/SP.F\_CV  
DVSYS.FIC-101/PID1/OUT.F\_CV.
- Click the Y-Axis tab and change the title to Flow.
- Enable the Apply to All Pens field.

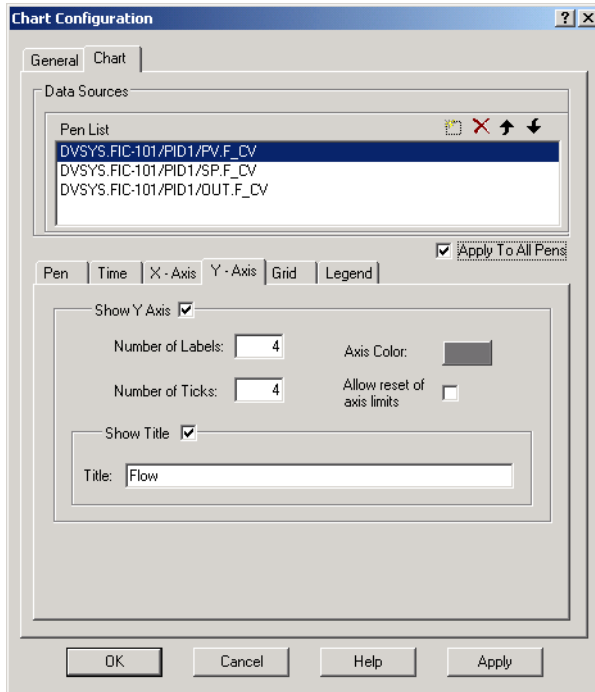

10. Click the X-Axis tab and change the title to Time.
11. Take all other defaults or experiment with the settings and click OK.  
The chart is placed on the picture.

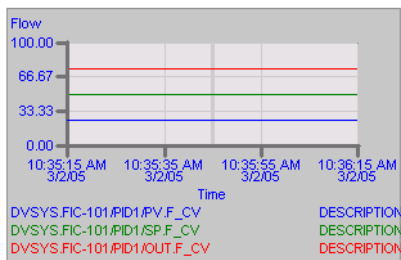

12. Save the picture.

---

## Setting Previous and Next Pictures

At the beginning of this chapter, we talked about picture hierarchies and linking pictures to make it easy for the operator to go through a series of related pictures in a defined order. You set the order by setting the Next and Previous Pictures in the Picture dialog box. The operator can go forward and back through the defined sequence by clicking the arrow buttons that are standard in the Main template.

The hierarchy for the tank process consists of a simple loop connecting the Overview and TANK101 pictures. The pushbutton jump from the DeltaV opening picture to the Overview already exists.

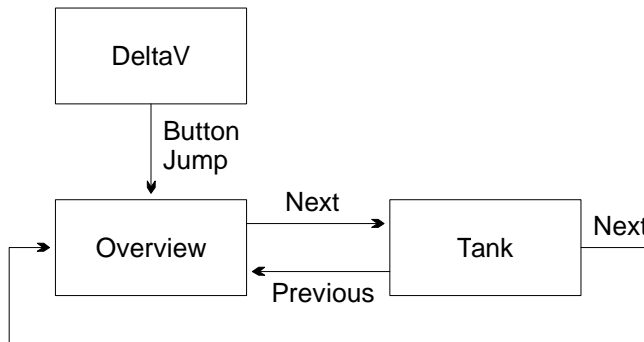

In a more complex system, this horizontal loop might contain a series of tank pictures or perhaps a progression from a tank picture to a boiler picture to a reactor picture. You can have a number of these horizontal loops to define sequences of related pictures. It is just a matter of determining the sequence you want and then setting the Next and Previous pictures.

In addition, you can have jump-style links, such as pushbuttons, to replace the current picture with one that is not in the defined sequence. Such links can be placed on your Overview picture or any other picture.



### To set TANK101 as the next picture for the Overview picture

1. Open the Overview picture (Ovw\_ref.grf) in the Pictures folder in the system tree. (Do not make any changes on this picture.)
2. Save the file as My\_Ovw\_ref.
3.  Double-click the Next and Previous picture button.
4. For the Next Picture, enter TANK101, and click OK.

5. Save and close the My\_Ovw\_ref picture.



### To link the TANK101 picture with the Overview

1. Open the TANK101 picture in configure mode if it is not already open.
2. Double-click the Previous and Next Picture buttons in the top left corner of the Tank101 picture.
3. For the Previous Picture, click the question mark button next to the Picture Name field.
4. Select My\_Ovw\_ref.grf and click Open.
5. For the Next Picture, click the question mark button next to the Picture Name field, select My\_Ovw\_ref.grf, and click Open.

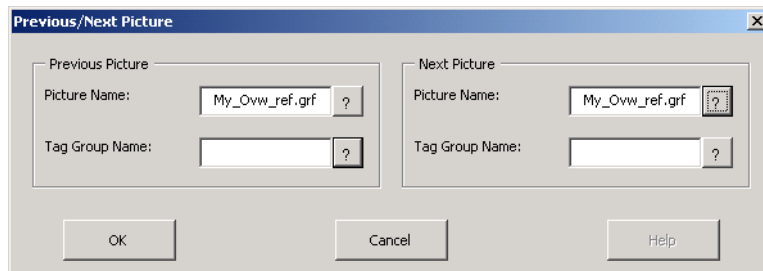

6. Click OK on the Previous/Next Picture dialog box.
7. Save the picture by selecting File | Save.

## Creating a Pushbutton to Start the SFC



After creating the control modules to monitor and control the equipment and flow loop, you created a Sequential Function Chart to automate the discharge process. Now you need a way to enable the operator to start the SFC.

There are a number of ways to do this. For instance, you could add another datalink that allows data entry, with the choices of START and STOP.

A simple method is to put a pushbutton on the TANK101 operator picture.



## To create a pushbutton to start the SFC

1. On the Menu bar, click Insert | Push Button.
2. Move the pushbutton to a blank area near the link named FIC-101/MODE.
3.  Click the Text tool on the Toolbox and type the text to appear on the button: Start Discharge.
4. Resize the pushbutton to accommodate the text label. To do this, click the box and drag one of the handles.
5.  Select the pushbutton and click the Task Wizard button on the Toolbar.  
The Task Wizard dialog box opens.
6. Select Command as the Task Category and scroll down to Write Value to Tag Expert in the Tasks list.

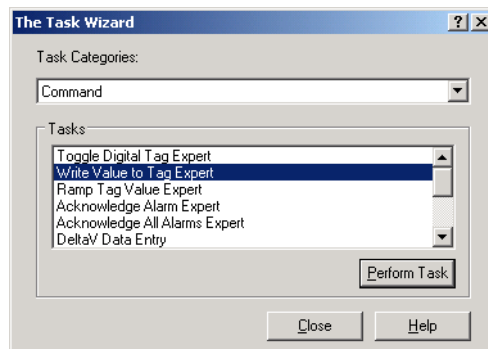

7. Click the Perform Task button.  
The Write a Value Expert opens.
8. In the Fix Database Tag field, type or search for:  
DVSYS.SFC-START/SPF\_CV
9. Click Numeric and type 1 in the Value field.



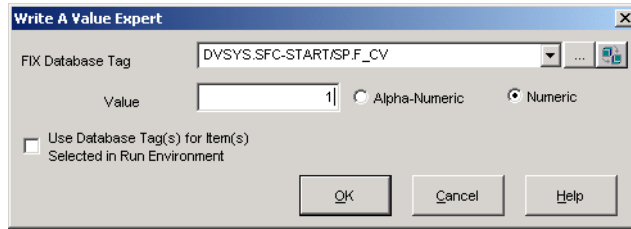

This command sets the value for the SFC to 1, which was defined to be the START value in the SFCCTRL named set.

10. Click OK on the Task Wizard.
11. Save TANK101.
12. Close DeltaV Operate.

**Note**

*Another way to assign the Start command to the pushbutton is to select the pushbutton, click the right mouse button, select Edit Script, and edit the Visual Basic script for the Pushbutton object.*



## Chapter 6 Using DeltaV Operate in Run Mode

DeltaV Operate, in run mode, provides a consistent, intuitive environment for process operation. A standard operator desktop and operating features make it easy to learn how to use this application.

If you have installed the control modules to a controller, you will see numbers (rather than question marks) when you go to the TANK101 picture. These numbers will not be realistic, unless you have I/O with actual signals. So, unfortunately, you will not be able to see the tank discharging its contents or get the full effect of working in an operator environment.



### To open DeltaV Operate

1. Click Start | All Programs | DeltaV | Operator | DeltaV Operate Run.

DeltaV Operate opens in run mode, displaying the DeltaV startup screen.

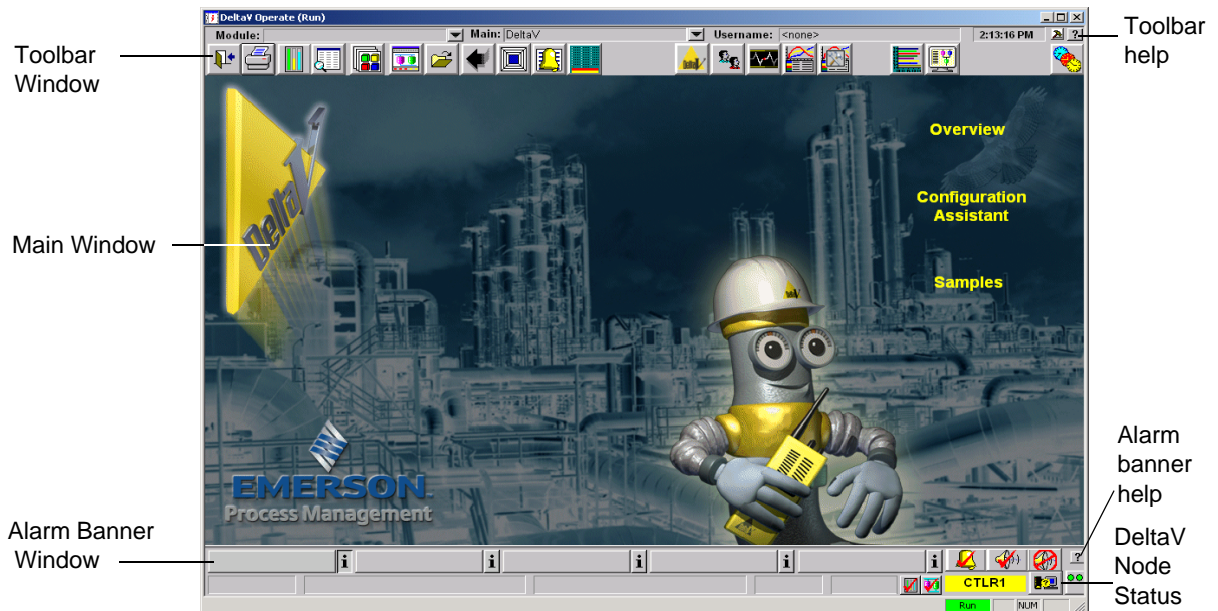



You may get a Data Retrieval Error. Click Skip All to skip all remaining messages of this type.

---

**Tip**  *If your picture does not line up correctly with the Toolbar and Alarm Banner windows, click the Reset Layout button to fix the layout.*



### To learn about the picture layout

1.  Click the small black question mark in the upper right corner.  
This displays a help system description of the buttons on the Toolbar.
2.  Click the Close button in the upper right corner of the help window to close the help window.
3. Click the small question mark in the lower right corner to see a description of the fields in the alarm banner at the bottom of the screen.
4. Click the Close button in the upper right corner to close the help window.
5.  Click the DeltaV Utilities button on the Toolbar.

This button opens a toolbar that contains links to other DeltaV applications (FlexLock, DeltaV Explorer, Control Studio, Recipe Studio, DeltaV Operate Help, and DeltaV Books Online).



6. Click the Books Online icon to open it. The DeltaV Operate section is titled “Operator Basics and Graphics Configuration.”
7. Click the Close button in the upper right corner of the Books Online to close that application.
8. Click the Overview button in the upper right corner to go to the Overview picture.

### Note

 *If your links were not set up correctly, you can open the TANK101 picture by clicking on the Open button on the Toolbar and selecting that picture.*

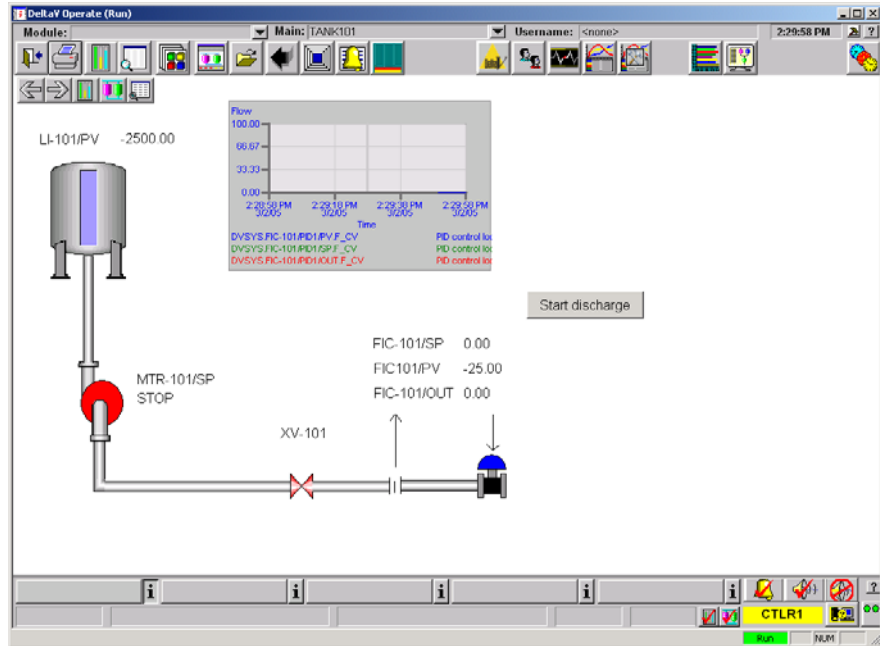

## Main History

The Main field in the Toolbar lists the name of the current picture. Operators can go quickly to another picture by clicking on its name in the Main History list.



### To open the Main History List

1. Click the arrow next to the Main field.



2. This opens a list of the pictures recently visited.

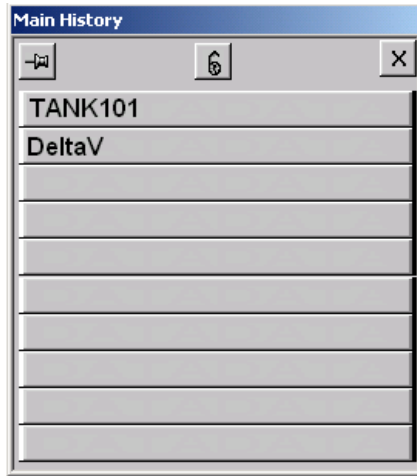

3. Click the pushpin button in the top left corner.

**Tip** *The pushpin button at the top of the Main History is a toggle switch for keeping the Main History open after a selection is made. The lock button locks the list, and the close button closes the Main History. You can predefine a Display History list and lock it using the UserSettings file mentioned at the beginning of Chapter 5, under “The Overview Picture and the UserSettings File”.*

4. Click DeltaV.
5. Click TANK101 to return to the process graphic.

---

## The Standard Buttons in the Main Window

The five buttons in the upper left corner are standard for all pictures created with the Main template.



Lets the operator navigate from the current picture to the those defined as Previous and Next.



Displays the Faceplate picture associated with the selected link.



Displays the Detail picture associated with the selected link.



Replaces the current main picture with the Primary Control picture for the selected link.

## Faceplate and Detail Pictures

To open a Faceplate or Detail picture for a module using the standard button in the upper left corner of the Main window, the module must first be selected by clicking on one of its data links.

The Faceplate allows access to the most important operating parameters. The Detail picture provides access to almost all tuning parameters and diagnostic information. DeltaV Library module templates have prebuilt Faceplate, Detail, and Trend pictures.

If the module does not have a selectable link, you can choose the module by clicking on the large Faceplate (or Detail) picture button in the main Toolbar. A dialog box opens in which you can enter the module name. The appropriate Faceplate or Detail picture pops up and the module name is added to the Module History list, which is similar to the Display History list. This list lets you select, for any module listed, the Faceplate, Detail, or Primary Control picture. As with the Display History list, the Module History list can be pre-populated and locked using the UserSettings file.



## To open a Faceplate and Detail Picture

1. Click the data link for FIC-101/SP.

Note that the data link in the upper right corner changes to display the currently selected link.

2.  Click the Faceplate button to call up the Faceplate for that module.

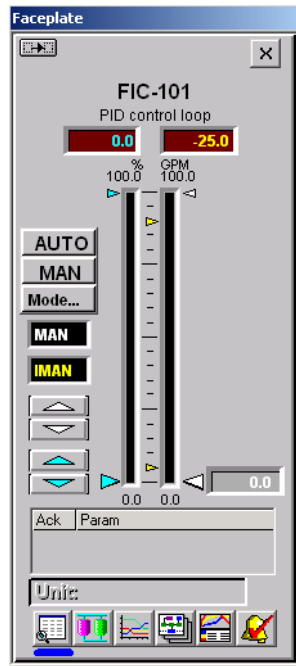

At the bottom of the Faceplate, notice that the Detail picture button has a blinking line under it. This indicates there is a problem with the module (in this case, there is no I/O).

3. Change the mode to Auto by clicking on the AUTO button on the Faceplate.
4. Change the setpoint by moving the slider bar (large white triangle) to a new value.

### Tip



*The Trend button at the bottom of the Faceplate brings up the prebuilt module-specific trend picture for any module created from a DeltaV Library template.*

5.  Call up the Detail picture by clicking the Detail button on the Faceplate picture or the Main picture.



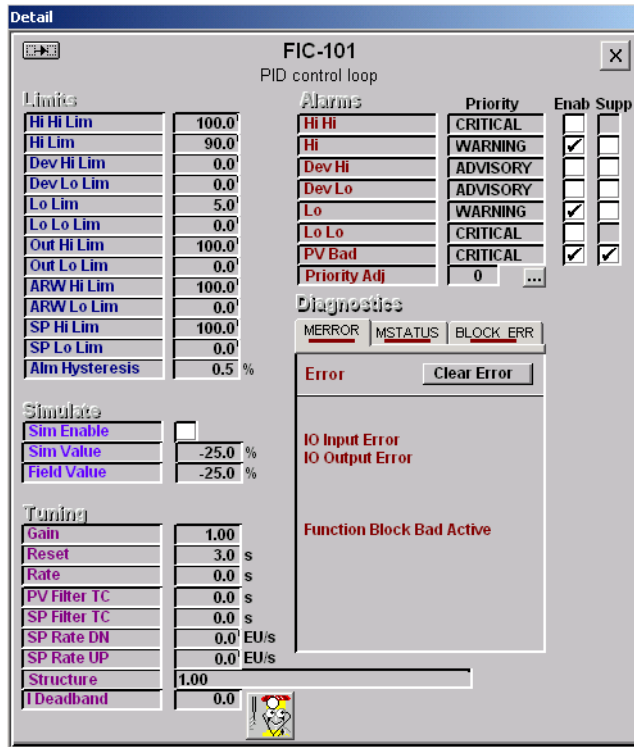

On the Detail picture, the operator can change tuning parameters (such as Gain and Reset), change high and low limits, and enable or disable alarms, if these have been configured as changeable.

6. Close the Detail picture.



---

To acknowledge alarms, you can

- Click the large Alarm button in the lower right corner of the Alarm Banner to acknowledge alarms in the main picture.
-  Click the Alarm button at the bottom of the module's Faceplate picture to acknowledge all alarms in that module.



If there is an audible alarm, click the Silence Horn button to silence the alarm. This does not, however, acknowledge the alarm.



In addition to the alarms displayed on the process graphics, a standard alarm list picture shows all active alarms and their priorities. To see the Alarm List, you can click the Alarm List button on the Toolbar or select the AlarmList picture from the Open | Replace dialog.

## On Your Own

This chapter briefly introduced a few of the features in DeltaV Operate run mode. Take a few minutes to get more acquainted with the application. Change some data values, click buttons on the Faceplate pictures, call up the Help system and online books, and skim through the Books Online table of contents. When you are done, close DeltaV Operate.



---

## Chapter 7 Collecting and Displaying Data

The DeltaV system supports the collection of user-specified parameter field values and alarms and events for long-term storage, retrieval, and presentation. There are three main aspects of continuous data collection and presentation:

- Detection by defining history collection in the modules and nodes
- Storage by the Continuous Historian subsystem
- Presentation through the Process History View application

The DeltaV system also lets you export data to the Microsoft Excel spreadsheet software so that you can use that application's extensive analysis and reporting features.

### Continuous Process Data Collection

The following subsections contain information on data collection in the DeltaV system.

#### History Collection

The history collection function defines the module or node parameters that are monitored and stored in the DeltaV Continuous Historian.

History collection is an integral part of a module. If you copy a module that has history collection, the new module includes the history collection. This enables you to set up history collection for key parameters and copy the module for similar applications. Library modules include history collection so that you do not have to set up history collection when you copy a library module to an area. You can add additional history collection to a library module.

In Chapter 4, we set up history collection in Control Studio for the module that we created from scratch (LI-101) and acquired history collection for the other modules that we copied from the Library.

---

## Continuous Historian and Alarms and Events Subsystems

Each workstation includes a Continuous Historian subsystem that detects and stores historical data and an Alarms and Events subsystem that detects and stores system events and alarms. The Continuous Historian subsystem monitors modules for history collection on an area basis and the Alarms and Events subsystem monitors for events and alarms on an area basis. If you move a module from one area to another, history collection moves with the module. For example, if a Continuous Historian subsystem is collecting history data from a module in AREA1, and you move another module to AREA1, all the history collection for that module is automatically added to that Continuous Historian subsystem.

You can establish duplicate data acquisition and storage by assigning an area to two or more Continuous Historian subsystems.

You must assign the areas from which you want to collect history to the subsystems, enable history collection on the workstation, and download the workstation through the DeltaV Explorer to activate the subsystems and view the data. You set up history collection for modules through the DeltaV Explorer or through Control Studio.

In the following exercises we will assign area TANK-101 to the Continuous Historian and Alarms and Events subsystems, enable history and events collection on the workstation, download the workstation, and view the data with the Process History View application.

### Assign TANK-101 to the History Subsystems

Assigning an area to a Continuous Historian subsystem allows the subsystem to collect historical data from the modules in that area. Assigning an area to the Alarms and Events subsystem allows the subsystem to collect alarms and events.



## To assign TANK-101 to the subsystems

1. Open or restore the DeltaV Explorer.
2. Navigate to the workstation where the events and process data for the area will be stored.
3. Double-click the workstation to expand its contents.

A number of icons, including an Operator icon, an Alarms and Events icon, a Continuous Historian icon, and a Batch Historian icon, are listed under the workstation.

4. Select Continuous Historian.
5. Click the right mouse button, select Assign Area, and browse for TANK-101.

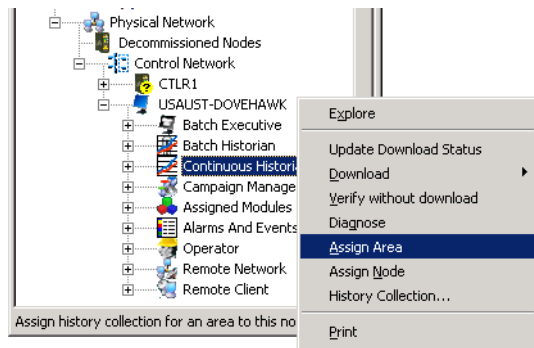

6. Click OK in the Browse dialog box.
7. Select Alarms and Events.
8. Click the right mouse button, select Assign Area, and browse for TANK-101.
9. Click OK in the Browse dialog box.

A confirmation dialog instructs you to download the station's setup data and then log off and back on to add the area to the alarm banner. Click Yes on this dialog.

TANK-101 appears in the Contents View for the Continuous Historian and Alarms and Events subsystems. The Continuous Historian subsystem will collect historical data from the modules in plant area TANK-101, and the Alarms and Events subsystem will collect alarms and events in plant area TANK-101.

The next step is to enable history collection on the workstation.

---

## Enable History Collection



### To enable collection from the Continuous Historian

1. Under the Workstation, click the Continuous Historian subsystem.
2. Click the right mouse button and then click Properties.

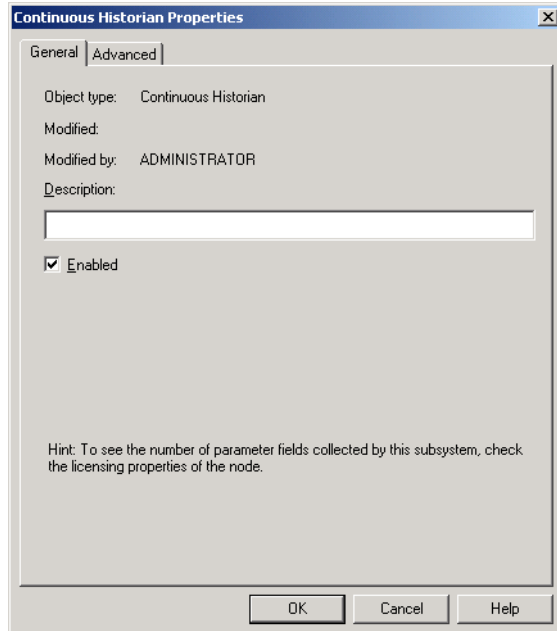

3. Click the Enabled check box.
4. Click the Advanced tab.



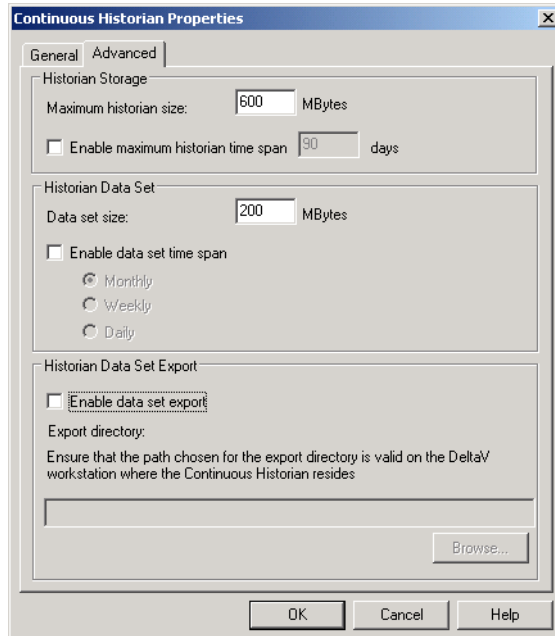

This tab lets you set the maximum size and time span for the historian database as well as the size of history data sets. You can also set up automatic export of history data sets by enabling that feature and then setting a valid directory path on the workstation, outside the DeltaV system. We will not make any changes on this tab.

5. Click OK.



### **To enable collection from Alarms and Events**

1. Under the Workstation, click the Alarms and Events subsystem.
2. Click the right mouse button and select Properties.

The Alarms and Events Properties dialog box opens.

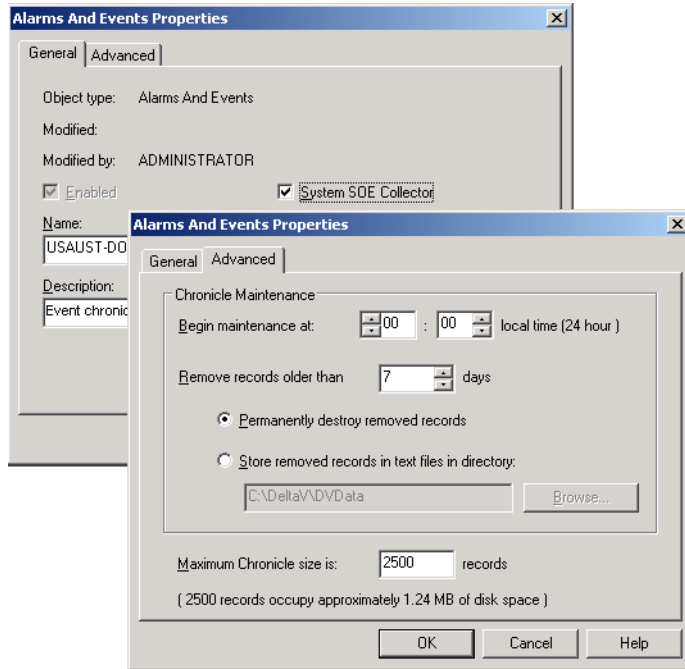

3. Click Enabled if it is not already selected.
4. Click the Advanced tab.
5. Set the Maximum Chronicle Size to 2500 records.
6. Click OK.

## Download the Workstation



### To download the workstation

1. Select the workstation you want to download.
2. Click the right mouse button and click Download | ProfessionalPlus Station.
3. Read the message and, if you are sure that you are not controlling a process, click Yes to acknowledge the message. (Accept the default option to verify the configuration.)

4. A window opens showing the progress of the download and providing details on any problems encountered.

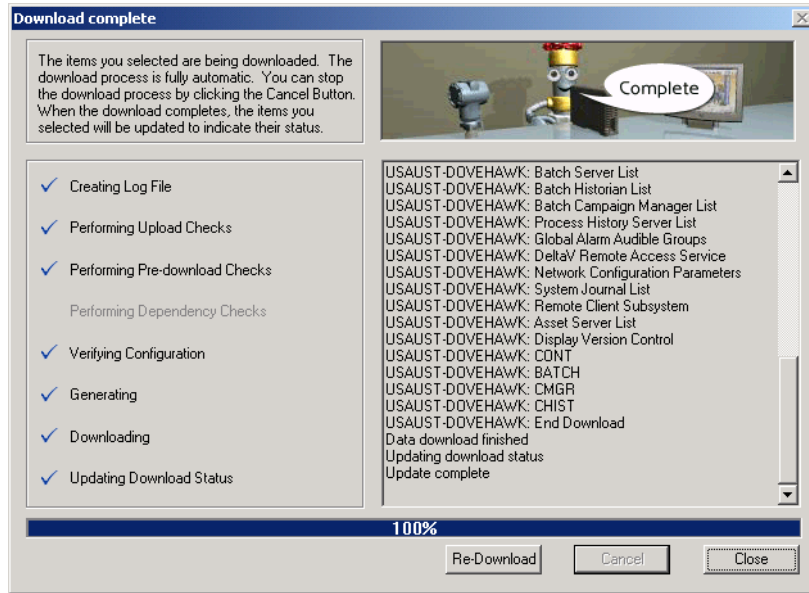

5. Click Close to close the dialog box.

We assigned area TANK-101 to the Continuous Historian and Alarms and Events subsystems, enabled history and events collection on the workstation, and downloaded the workstation. Now we will use the Process History View application to view the data.

## View the Data

Now that you have defined the data you want collected and told the system to start collecting it, you can create a chart to plot the module trends and show events. There are three types of Process History documents:

- E +Chart — shows module trends plotted on a graph and historical events displayed in a grid
- Chart — shows only module trends plotted on a graph
- Event — shows only historical events displayed in a grid



## To start Process History View

1. Click Start | All Programs | DeltaV | Operator | Process History View.
2. Select File | New.
3. Click E +Chart in the New dialog box.  
The Configure Chart dialog box opens.

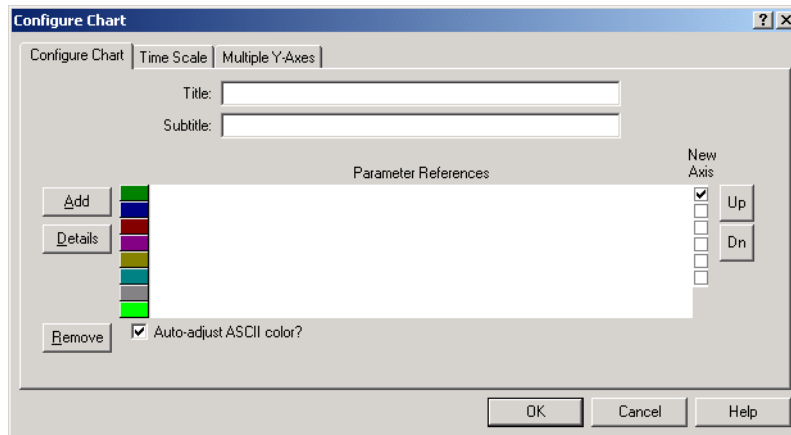

4. Click the Add button and then click the Browse button on the Parameter Reference Entry dialog box.
5. Select Module Parameters in the Object Type field and browse in the TANK-101 area for FIC-101/PID1/PV.CV to plot the value of the outlet flow.

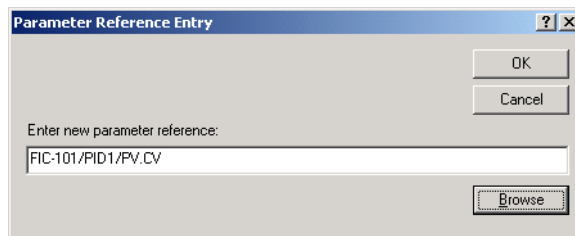

6. Click OK in the Parameter Reference Entry dialog.
7. Back in the Configure Chart dialog, click Add and browse for LI-101/AI1/PV.CV to plot the value of the tank level in the tank process.
8. Click OK.

- Click in the New Axis check box for LI-101/AI1/PV.CV.

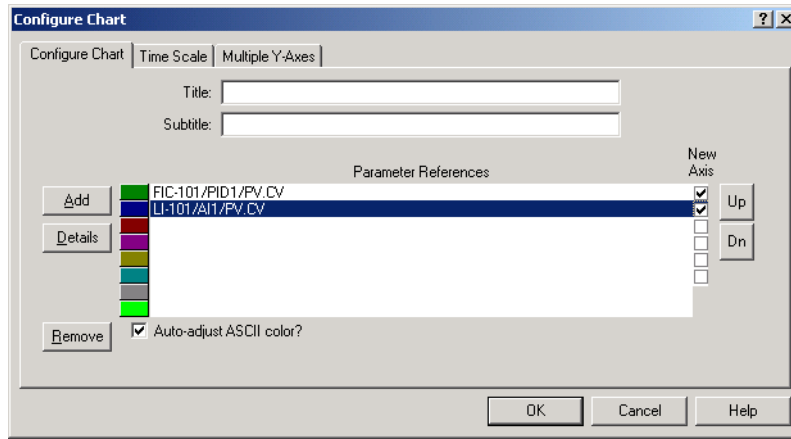

- Click the Multiple Y-Axes tab.
- Click the down arrow and select 50/50 in Axes Styles box to create two Y scales to plot the data values.

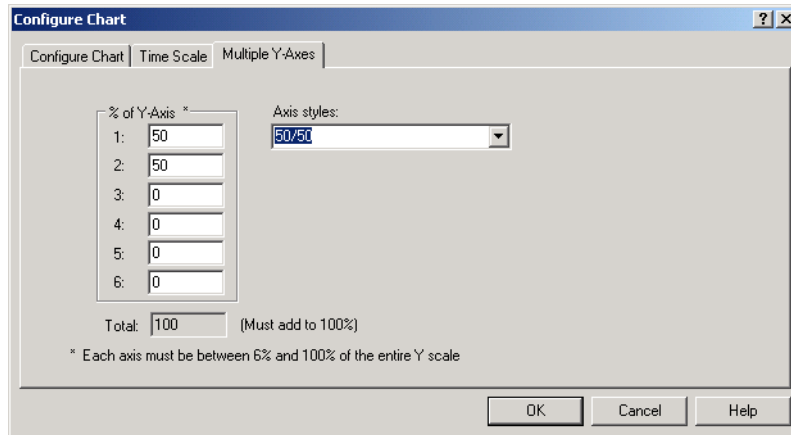

- Click the Configure Chart tab, and enter MYGRAPH as the Graph Title.
- Click OK to close the Configure Chart dialog.

The graph appears, showing module trends for the two parameter references, as well as the events in area TANK-101.

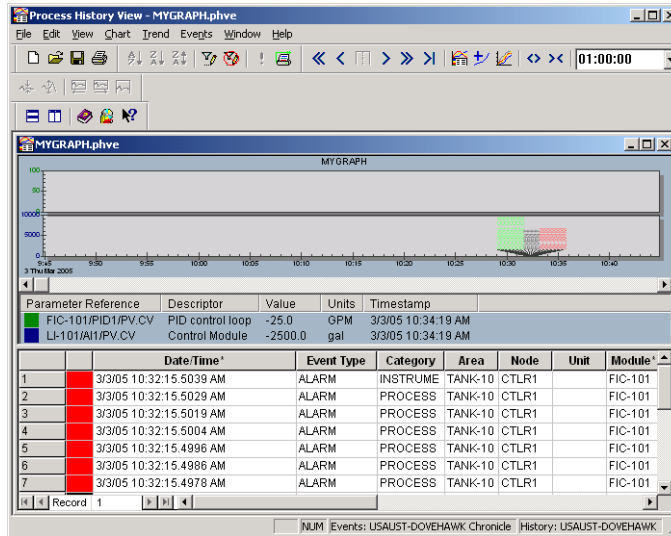

The Process History View application has numerous graph configuration options and event filtering options that are described in the Online Help.

**Tip** Click *Trend | Plot Method* to change the line style.

14. Close the Process History View application.

## Excel Add-In

The Excel Add-In lets you read and write DeltaV parameters through Microsoft Excel. You can use the reporting and database management power of Excel to generate reports, create charts, and customize tasks.

In this exercise, you will set up an Excel worksheet to read a parameter value from the control strategy you installed in your controller. This includes setting up the Add-In, setting an update interval, and reading a parameter. This exercise assumes that you have Excel installed on this workstation, that you are familiar with Excel, and that you have installed your control strategy in the controller.

### Setting up the Excel Add-In

In order to use the Add-In, you must select the Add-In from Excel. This makes the Add-In functions available to you any time you use Excel. If the Add-In is loaded when Excel is shut down, it will still be loaded when Excel is started again.



### To set up the DeltaV Excel Add-In

1. Start Excel.
2. Select Tools | Add-Ins.
3. In the Add-Ins dialog box, select Browse and navigate to the Excel directory in your root DeltaV directory. For example,  
C:\DeltaV\Excel
4. Select DeltaV.xla and click OK.

The Add-Ins dialog box now has an entry for DeltaV Real-time Data that is checked.

### Using the Excel Add-In

After you load the DeltaV Excel Add-In, Excel shows a floating toolbar with two DeltaV function wizard buttons on the worksheet. The function wizard helps you create DeltaV functions on your worksheet that let you read and write real-time data and execute write functions.



### To set the update interval

1. Select a cell in the workbook where you want to store the update interval. The update interval is the rate at which the workbook data is refreshed.

2.  Click the Create DeltaV function wizard button.

The first function wizard dialog appears.

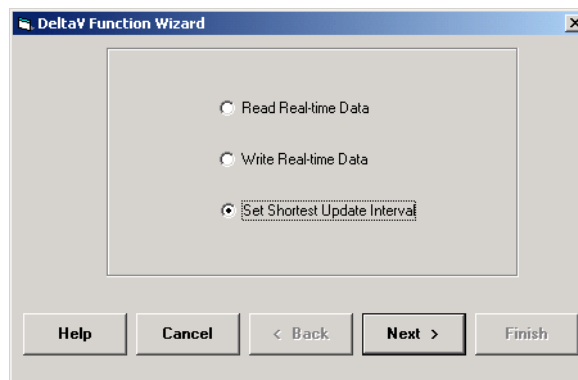

3. Click Set Shortest Update Interval and click Next.

---

The Set Minimum Update Interval dialog appears.

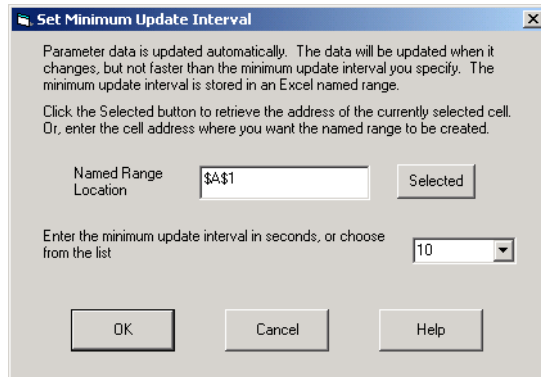

4. Click Selected so the update interval is stored in the currently selected cell.
5. Select an update interval.  
The smallest recommended update interval is 5 seconds.
6. Click OK.



#### **To read a parameter value**

1. On the worksheet, select a cell to contain a DeltaV read function. (Select a different cell than the one containing the update interval.)  
This is where the Add-In will write the parameter value. Choose a cell with at least one blank cell to the left. The blank cell will be used to display the parameter name you are reading.
2. Click the Create DeltaV function wizard button.
3. On the Function Wizard dialog, click Read Real-Time Data and click Next.
4. On the Read Real-Time Data dialog, click Browse to select a parameter.  
The Browse Parameters dialog appears. To read the value of the tank level in the tank process, browse for the PV of LI-101.
5. In the TANK-101 area, double-click LI-101, double-click the PV parameter, and double-click the CV field.
6. Make sure the data type is set to numerical to return a numeric value.



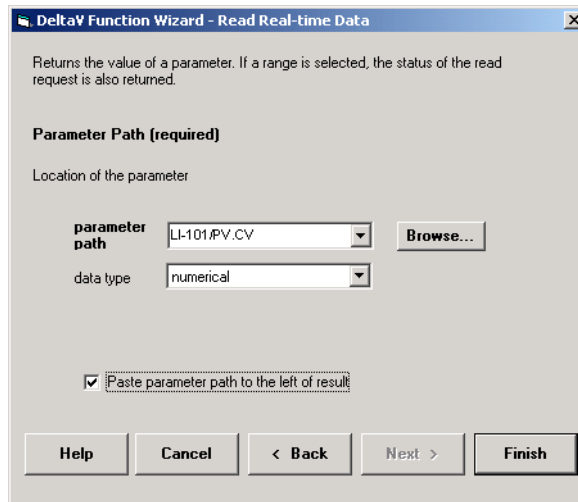

7. Select the check box to have the parameter path pasted to the left of the function that is being created.
8. Click Finish.

**Note**

*Because this is not a working process, the read cell will not return a process value. If the process were running, this cell would show the value of the tank PV and would update at the update interval.*

9. Close Microsoft Excel without saving the workbook.

## Continuous Historian Excel Add-In

The Continuous Historian Excel Add-In provides four functions (to configure single value, raw, interpolated, and calculated data) that aid in the creation of detailed Excel workbooks containing historical data read from the Continuous Historian database. Refer to the Continuous Historian Excel Add-In topic in the Books Online Configuration book for more information on this add-in.



---

## Chapter 8    **Configuring the Network, Loading and Assigning Licenses, and Setting Up User Accounts**

After physically connecting the hardware, you need to *configure* the hardware so that the DeltaV system can get the controllers, workstations, and I/O working together and working with the DeltaV software. As soon as you have configured your first workstation, you need to set up a user account using the DeltaV User Manager, described later in this section.

**Important**    *The first user must log in using the Administrator account. The default password for this account is `deltav` (lowercase). The first thing that person must do is to change the account password and then change the passwords on the administrator accounts on the other workstations to match this password. Then, the administrator should configure the ProfessionalPLUS Workstation, load and assign licenses, and download that workstation's configuration.*

In this section you will learn how to configure the controller and workstation nodes as well as the I/O. Before configuring, your hardware should be connected and running. Refer to the manual *Installing Your DeltaV Digital Automation System* if you need information on the physical installation of the hardware.

Look at the DeltaV Explorer screen below to see how the controllers, workstations, and I/O fit into the overall structure of a DeltaV process system. The numbers show the typical sequence for configuring the hardware.

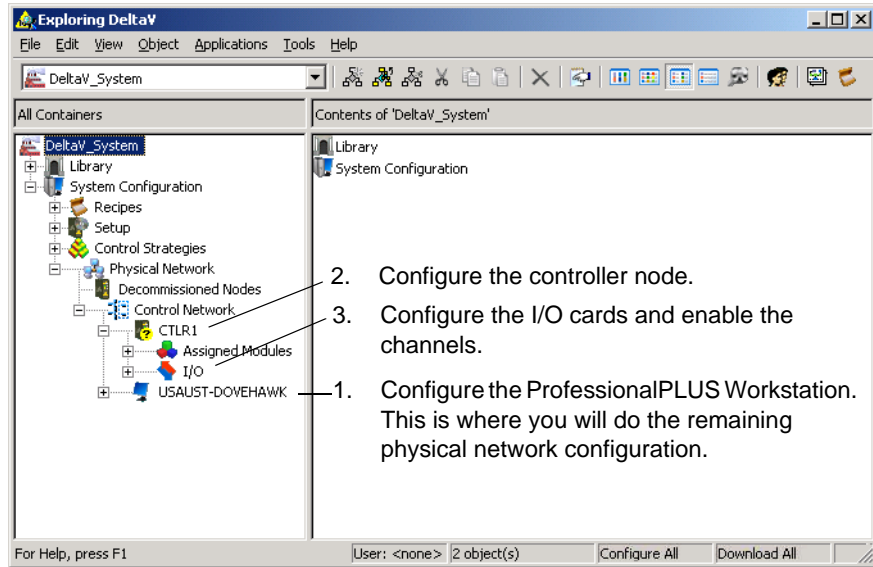

## Configuring DeltaV Workstations

The DeltaV system provides a Workstation Configuration application that steps you through the procedure for configuring the workstations in your system. This application must be run the first time a workstation is used as a DeltaV workstation.

You must configure the ProfessionalPLUS workstation first. There can be only one ProfessionalPLUS Workstation in a DeltaV system. If there are other workstations to be configured, you will write the device configuration information to a floppy disk (from the ProfessionalPLUS workstation) to configure those workstations.

The specific steps that you take to configure the ProfessionalPLUS workstation vary depending upon the configuration options that you choose. Refer to the Workstation Configuration online help as you configure your workstations. Click the Help button or use the context sensitive help to access additional information. Most of the screens are self-explanatory and easy to fill out.

Basically, configuring a ProfessionalPLUS workstation involves defining the workstation as the ProfessionalPLUS (with the same name as the workstation), and making network settings. Configuring other workstations involves a few additional steps.

After you configure the workstations, you will load and assign licenses and download the workstations in the DeltaV Explorer.

---

## Accessing DeltaV Workstation Configuration

When you start up a workstation for the first time, the DeltaV Workstation Configuration application comes up automatically. If you elect not to configure the workstation right away, then you will need to open the application from the DeltaV program group when you are ready to perform the configuration.

You cannot do any work with the DeltaV system until the workstation is configured.



### To access the Workstation Configuration application

1. Click Start | All Programs | DeltaV | Installation | DeltaV Workstation Configuration.

The initial screen appears.

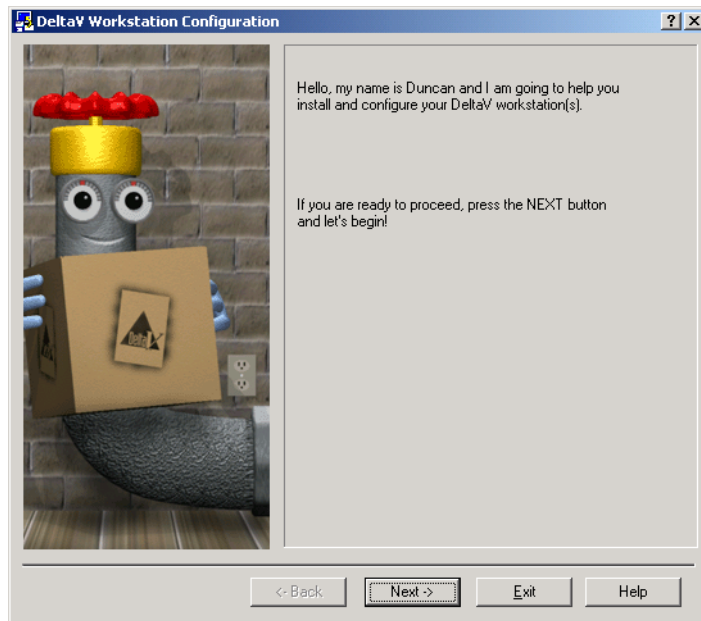

2. Click the Help button to familiarize yourself with the application and when you are ready to begin the configuration, click Next.
3. Select ProfessionalPLUS workstation and click Next.

The Workstation Configuration application guides you through the process of configuring the ProfessionalPLUS. Remember to refer to the online help for complete information on configuring the ProfessionalPLUS workstation.

---

**Important** *If your workstation has already been configured, do not repeat this procedure.*

The Workstation Configuration application sets up the workstation's network settings and creates the initial database to hold the DeltaV system configuration. This process may take several minutes to complete. You are instructed to restart your computer for the configuration changes to take effect.

## DeltaV Software Licenses

Before you can download your DeltaV software configuration, you must attach the System Identifier to the ProfessionalPLUS workstation, load your licenses on the ProfessionalPLUS workstation from a diskette, and assign licenses to the workstations and controllers in your DeltaV network. Before loading and assigning your licenses, take a few minutes to read the next sections about DeltaV software licenses.

### System Software

Major system software versions require a license. A major version is one in which the first digit in the version number changes from the previous version. A Major Version License is required when you upgrade from one major version to another and for first-time installations.

### Controller Software

Controller software for continuous control is licensed through four I/O-based, system-wide licenses. For batch control, a fifth system-wide license is added; it is the Advanced Unit Management license. The system-wide licenses are assigned to the ProfessionalPLUS workstation and determine both the functionality available in every controller in the system and the potential size of the system. System size is expressed in Device Signal Tags (DSTs).

When purchasing controller licenses, it is necessary to understand the difference between the four I/O-based licenses, which are:

- Discrete Monitor Input
- Discrete Control Output
- Analog Monitor Input
- Analog Control Output

---

For the controllers in your system, select specific DST sizes of the four I/O-based licenses by counting the number of discrete inputs, discrete outputs, analog inputs, and analog outputs required for your process.

Purchase each license with a DST size equal to or greater than the total number of input or output signals it represents. For example, purchase a 100-DST Discrete Monitor Input license to bring in up to 100 discrete inputs into the controller(s). Or purchase a 100-DST Analog Control Output license get up to 100 analog outputs from the controller(s). The licenses allow input and output signals via conventional I/O, bus I/O, or Serial I/O. Books Online provides a more detailed definition of the system-wide controller licenses

If your process is batch, select an Advanced Unit Management license with a DST size equal to the number of DSTs used for class-based units.

You also specify the total number of DSTs (the sum of all DSTs associated with the four I/O-based licenses) when selecting a ProfessionalPLUS license.

## Workstation Software

When installing DeltaV Software on a PC or server, the installation wizard enables you to define the PC or server as one of three node types: ProfessionalPLUS, Operator, or Application. After the software installation is complete, you determine the functionality and size of the station with software licenses. Key licenses are bundled in software suites. Each suite enables the use of specific functions and applications as defined in the product data sheets. The following table defines which software suites can be assigned to the three node types:

*Table 8-1 License Suite Assignments for Workstations*

<b>Workstation Node Type</b>	<b>Supported Software Suites</b>
ProfessionalPLUS Station	ProfessionalPLUS
Operator Station	Base, Maintenance, Professional, and Operator
Application Station	Application

After you install a license suite, you can install add-on and scale-up licenses. Add-on licenses add new licensed features and functionality to the initial license and scale-up licenses increase the capacity of an existing license feature.

---

## Redundant Controllers

Each pair of redundant controllers requires a separate redundant controller license.

## Loading and Assigning Licenses

Use the DeltaV Explorer from the ProfessionalPLUS workstation to load the licenses from the license CD (located in the License Pack), and then assign the licenses to nodes.

### **Tip**

*Be sure that the System Identifier (also located in the License Pack) is attached to the ProfessionalPLUS workstation, and be sure to have the license CD ready. To verify that the System Identifier is attached, select Help | About... in any DeltaV application.*

## Loading Licenses

From the ProfessionalPLUS workstation:

1. Click Start | All Programs | DeltaV | Engineering | DeltaV Explorer to open the DeltaV Explorer.
2. Insert the license CD into the CD or DVD drive.
3. In the DeltaV Explorer, select File | Licensing | Load License File. The Load License File dialog opens:



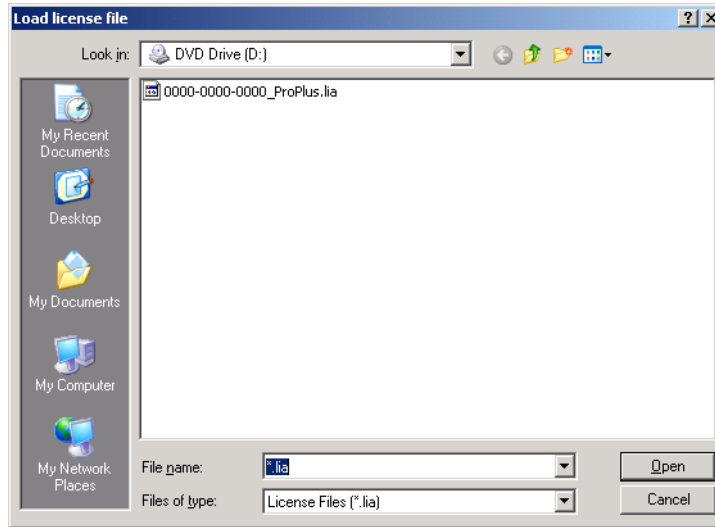

**Tip**

*You can also select System Configuration/Setup/Licenses in the left pane of the Explorer, click the right mouse button, and select Load License File.*

4. Select the license file to load, and click Open.
5. Read the information in the Terms and Conditions dialog box and, if you agree, enter the requested information, and click Next. If you do not agree, return the license CD and System Identifier to Emerson Process Management.
6. Fill in the information on the User Contact Information dialog box and click Next.
7. Fill in the End User Company Information dialog box and click Next.
8. Read the information in the Registration dialog box, and then click Finish.
9. The licenses are loaded into the License folder. The license folder is found in System Configuration | Setup in the left pane of the Explorer. Select the Licenses folder to view the licenses.

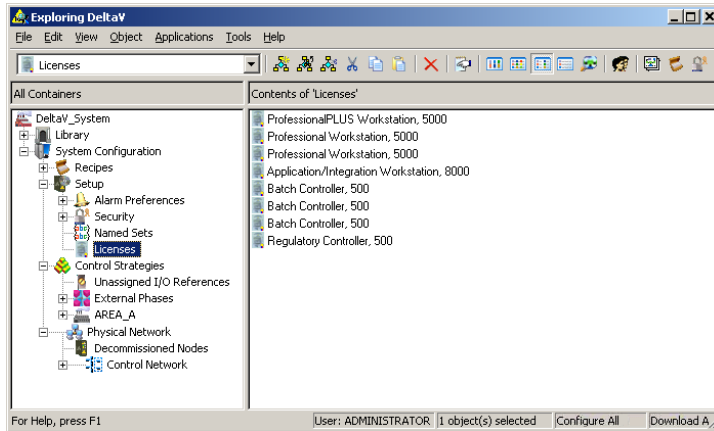

10. Now you can assign the licenses to nodes.

**Tip** *Consider creating a backup copy of the license file. Select File | Licensing | Create License File to create a backup copy of the licenses.*

**Note** *Your licenses are exported if you completely export your DeltaV system.*

## Assigning Licenses to Nodes

After the licenses are loaded, you assign them to nodes (workstations and controllers). Typically, controllers require one license (unless you purchase scale-up licenses for the controller) and workstations require one or more licenses.



### To assign licenses

1. Select the node, click the right mouse button, and select Licensing | Assign License.

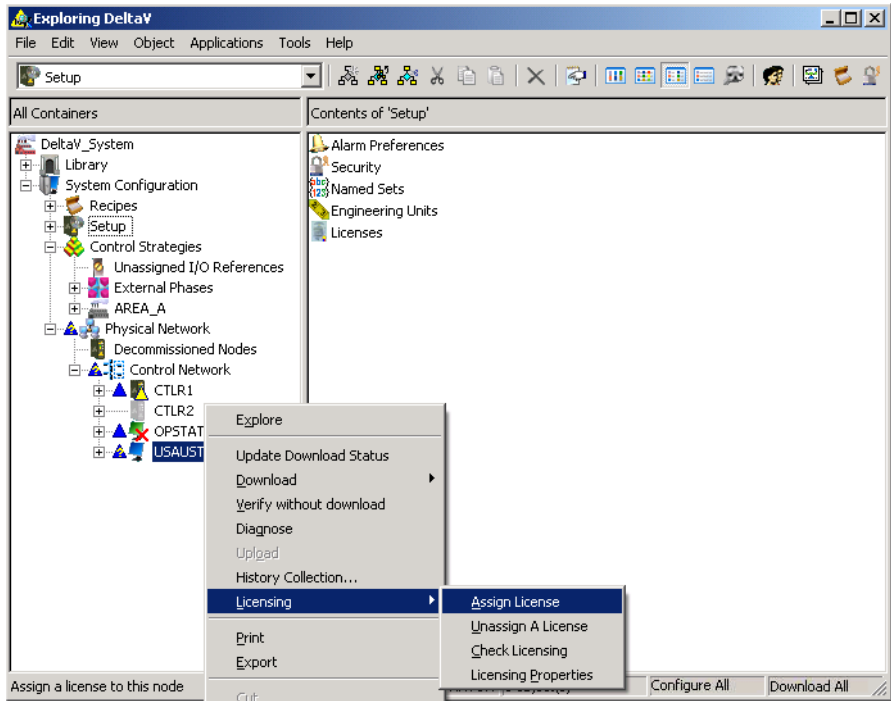

A dialog box opens showing only the compatible licenses for that node. Because the selected node is a controller node, multiple types of licenses are compatible with it, as shown in the following figure.

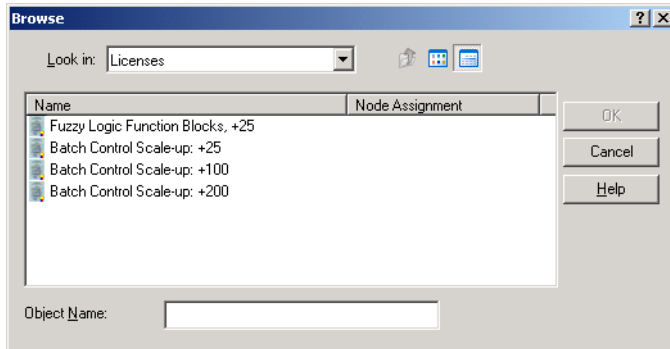

2. Select the licenses that you want to assign to the node and click OK.



## To see license details

1. Select the node for which you want to see license details, and click the right mouse button.
2. Select Properties from the context menu and click the Licensing tab.

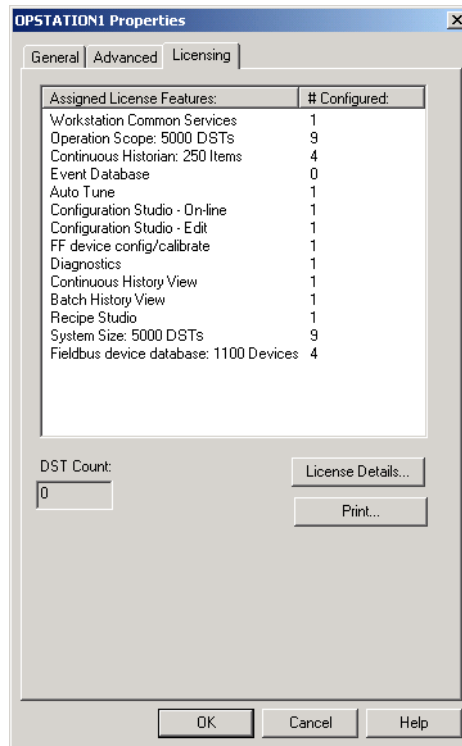

The Licensing Properties page shows the assigned license features and the number of features (DSTs, items, and devices) configured on the node.

3. Click the Licensing Details button to see details on the license features included on each license.

There are two other ways to assign licenses:

1. Open the Licenses folder (under System Configuration | Setup), drag a license from the list, and drop it onto a node.
2. Open the Licenses folder (under System Configuration | Setup) and use the license's context menu to assign the license to a node. The context menu is accessed through the right mouse button.

## Note

When you drag a license from the licenses folder onto a node, you must choose the license from the entire license pool. When you assign a license using the license's context menu, you are given a list of compatible nodes for the license.

Now that you have assigned your licenses, you can download the configuration for your workstations and controllers.

## Downloading the ProfessionalPLUS Workstation

When you have finished configuring the workstation and assigning licenses, you need to download the configuration. Before you download, make sure the System Identifier has been connected to the ProfessionalPLUS workstation.



### To download the workstation configuration

1. Start the DeltaV Explorer by clicking Start | All Programs | DeltaV | Engineering | DeltaV Explorer.
2. Under Control Network, select the workstation, click the right mouse button, and select Download | ProfessionalPlus Station from the menu.

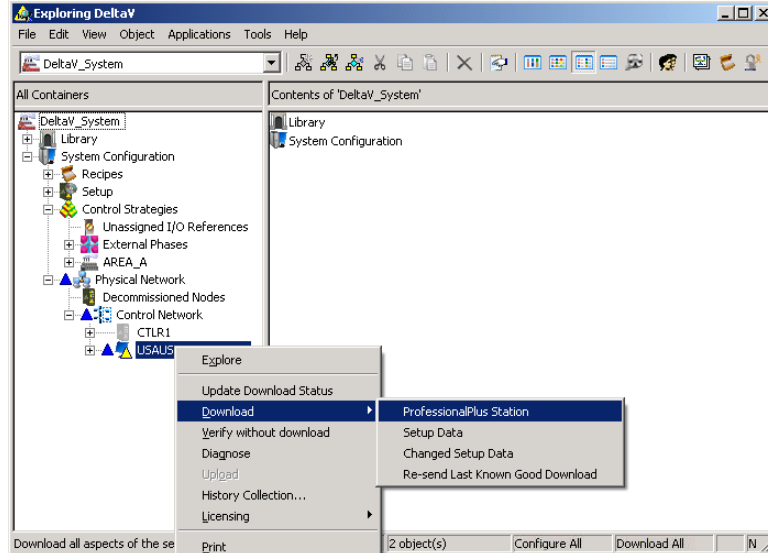

3. Read the message and, if you are sure that you are not controlling a process, click Yes to acknowledge the message and accept the defaults in the Confirm Download dialog box.

A window opens to show the progress of the download and give you details about any problems encountered.

4. Click Download Anyway if the Configuration Check Results message box appears to continue the download.

Since we have not assigned I/O you will probably get some configuration messages.

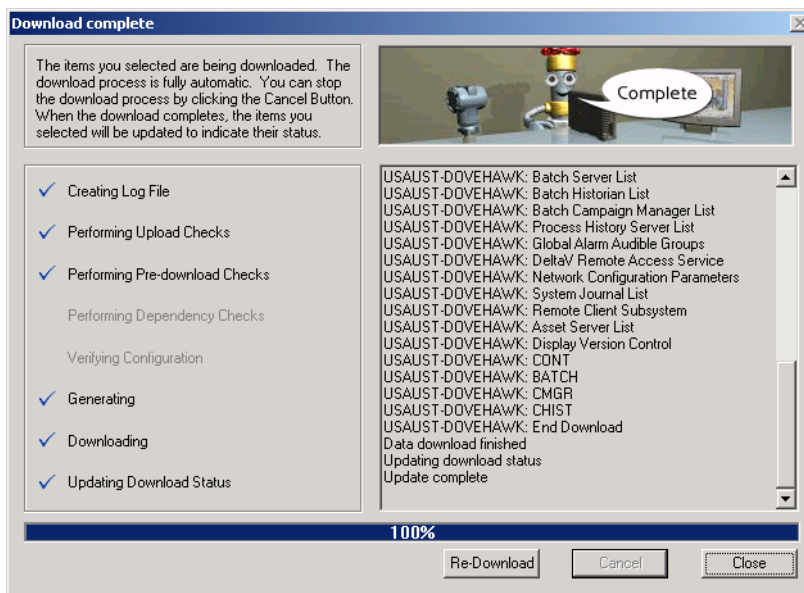

5. Click Close to close the Download dialog box.

## Configuring Other Workstations

Prior to configuring other workstations, you need to add their names to your Control Network in the DeltaV Explorer. Then create a configuration floppy disk from the ProfessionalPLUS Workstation to configure the other workstations.

The ProfessionalPLUS and other workstations must be connected to the network before the Workstation Configuration is run. Workstations must be able to communicate with the ProfessionalPLUS workstation for a successful download.

The following steps are performed on the ProfessionalPLUS Workstation.



## To add other workstations to the DeltaV Explorer

1. On the ProfessionalPLUS Workstation, open the DeltaV Explorer.
2. Select Control Network and click the right mouse button.
3. From the context menu, select New | Operator Station.

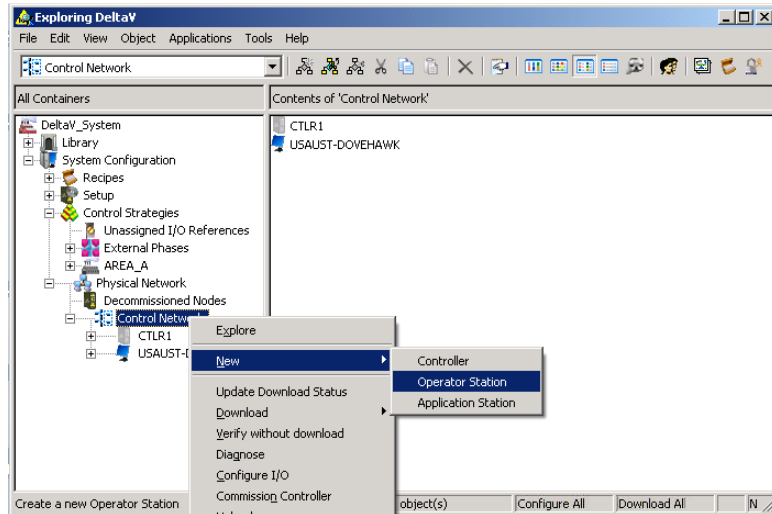

The Node Properties dialog box opens.

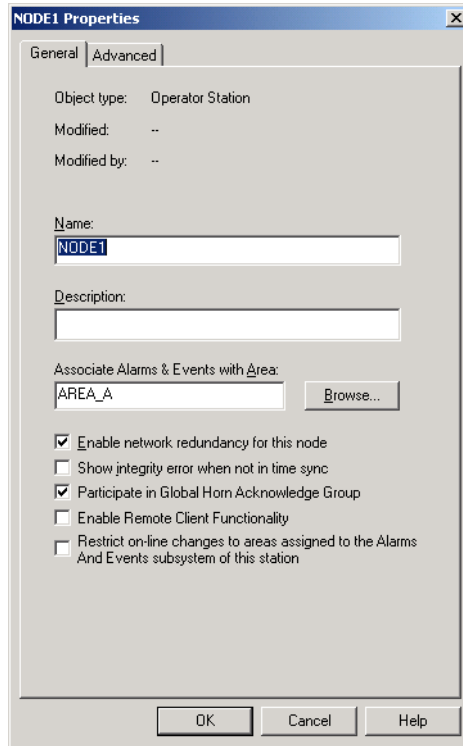

4. On the General tab, enter the name for the Operator Station.
5. Accept the default settings and click OK.
6. The new workstation node appears under the Control Network.

**Important** *For remote nodes, the new workstation node names must be the same as the Windows names for those machines.*

**Note** *By default, the new workstation node is redundant. If you want this new workstation to be simplex, deselect Enable network redundancy for this node.*





## To create a configuration diskette

If you decide not to immediately create a configuration diskette after adding workstations to the DeltaV Explorer, you need to later access the procedure manually.

The following steps are performed on the ProfessionalPLUS Workstation. You will need a blank diskette to insert in your floppy drive to store the configuration file.

1. Open the DeltaV Explorer if it is not already open.
2. Insert a blank diskette in drive A:.
3. Select Physical Network and click the right mouse button.

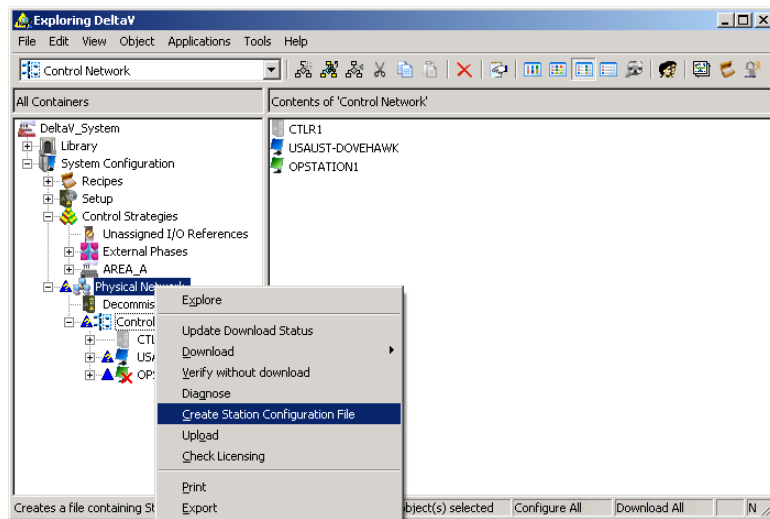

A context menu appears.

4. Select Create Station Configuration File from the context menu.

A dialog appears for you to specify the file name and destination. The default file name is DevData.cfg and the default drive is A:.

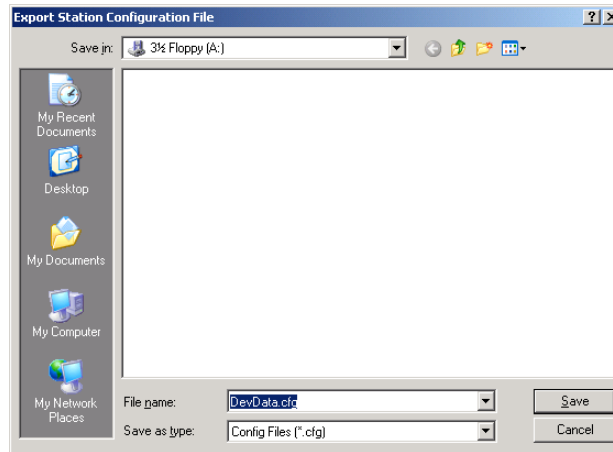

5. Click Save.



### **To configure other workstations**

These steps are performed on the other workstation.

1. Open the Workstation Configuration application by clicking Start | All Programs | DeltaV | Installation | DeltaV Workstation Configuration.
2. Click Next on the opening screen.
3. Select Other Workstation and click Next to continue.

The Workstation Configuration application guides you through the process of configuring the workstation. Remember to refer to the online help. This process may take several minutes to complete. You are instructed to restart your computer for the configuration changes to take effect.

If you have more workstations to configure, take the disk to the next workstation and repeat the procedure.

When you have finished configuring the workstations, you need to download the workstation configuration. On each machine, perform the Workstation download procedure described earlier under “Downloading the ProfessionalPLUS Workstation”.

---

## Configuring the Controller Node

The DeltaV system allows you to configure your controllers and I/O before the hardware is connected. By configuring a controller placeholder, you can perform most of your hardware configuration off-line. After you have physically connected the controller, you can easily assign it to the placeholder.

For information on connecting your hardware, refer to the manual *Installing Your DeltaV Digital Automation System*. When you power up your system, any controllers that are physically connected will be sensed by the DeltaV system and listed in the DeltaV Explorer as decommissioned controllers. At that point you can drag-and-drop a decommissioned controller to your control network or to a specific controller placeholder that you have configured in advance for that controller.

If you want to do the tutorials in Chapters 3 through 7 of this book, you can set up a controller placeholder called CTLR1 and then configure I/O channels for it according to the instructions in the next section.



### To create a controller placeholder

1. On the ProfessionalPLUS Workstation, open the DeltaV Explorer.
2. Select Control Network and click the right mouse button.
3. From the context menu, select New | Controller.

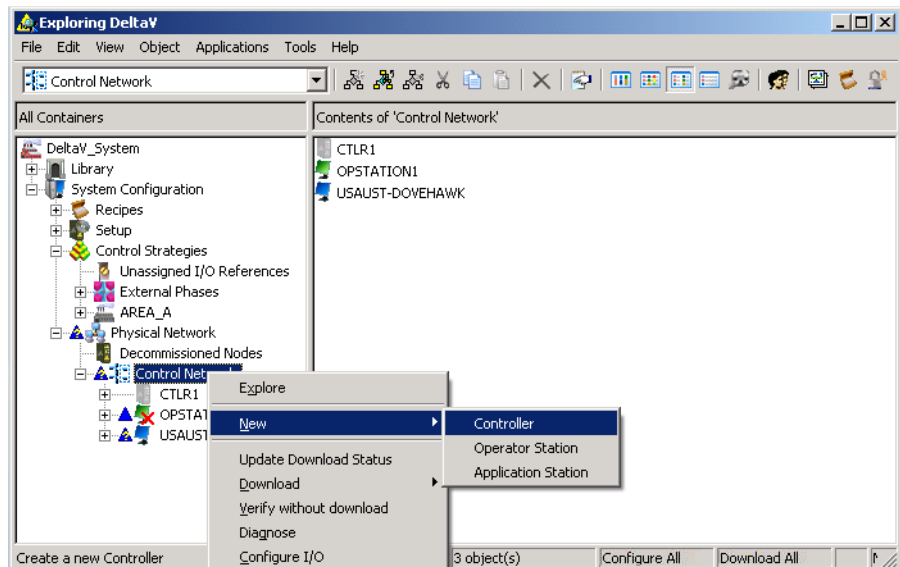

---

A new controller, named NODE1, is added under the Control Network. The name appears in the right pane in an edit box, ready for renaming.

4. Rename the controller to something meaningful for your system.

**Note**

*A red X next to a controller means that it is not communicating.*



**To view controller properties**

(These are general instructions and are not part of the tank process tutorial. If you have a controller and I/O connected, they are not likely to match the hardware specifications for the example.)

1. In the DeltaV Explorer, select System Configuration | Physical Network | Control Network | *controller placeholder*.
2. From the context menu, select Properties.

The controller Properties dialog appears, as shown in the next figure.

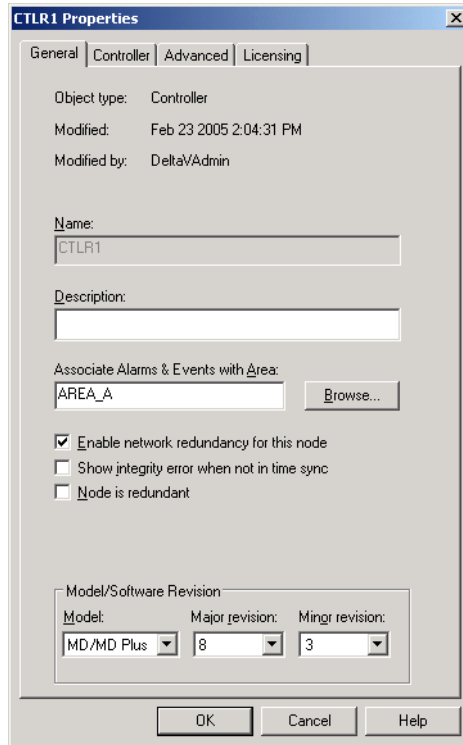

3. Select an Area to associate alarms and events with and select the checkboxes required for your installation. You do not need to set any values in the Model/Software Revision area. Accept the defaults. When you download, the DeltaV system updates the values in this area to reflect the controller model and software revision in your system.



## To locate and configure a connected controller

(These are general instructions and are not part of the tank process tutorial. If you have a controller and I/O connected, they are not likely to match the hardware specifications for the example.)

1. In the DeltaV Explorer, select System Configuration | Physical Network | Decommissioned Nodes.
2. Select the decommissioned controller in the right pane.

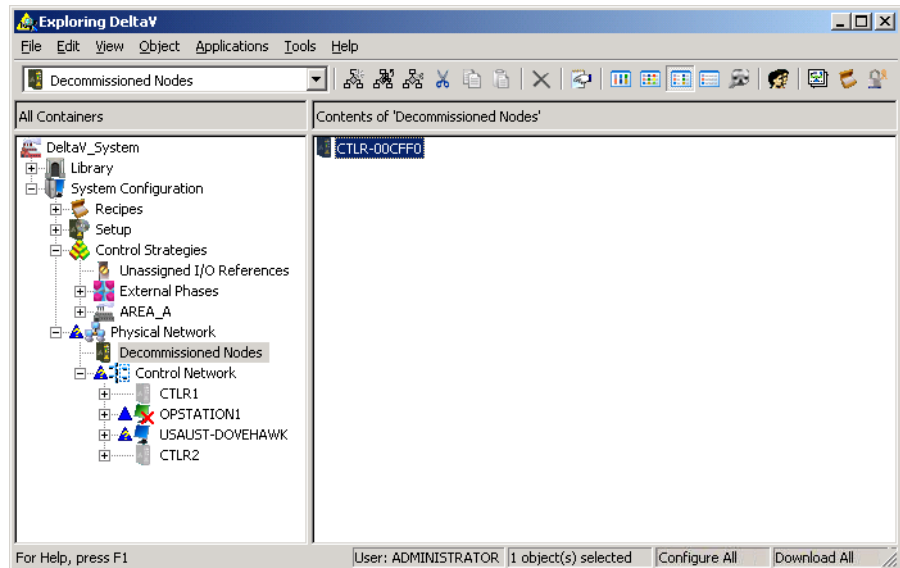

3. Drag-and-drop the decommissioned controller to Control Network or to a specific controller placeholder.
  - If you drag the decommissioned controller to Control Network, a Properties dialog box opens for you to enter a name for the controller. Then you will be asked if you want to auto-sense the I/O cards. For a new controller, for which you have done no configuration, you would normally answer yes.
  - If you drag the decommissioned controller to a placeholder, such as CTRL1, you will be asked if you want to auto-sense the I/O cards. If you have already configured I/O cards for the placeholder controller (which you will learn how to do in the next section), answer no. If you answer yes, the autosensed cards will be compared to the ones configured, and any mismatches will be displayed. You can replace any empty slot with an autosensed card. To replace mismatched cards, you must delete the configured cards.

---

**Note** *You can also commission a controller by selecting the context menu item, Commission. Access this menu item by pointing to either Control Network or a controller and clicking the right mouse button.*

**Tip** *You can identify a decommissioned controller and confirm that it is communicating by selecting the controller, clicking the right mouse button, and selecting Properties. Select the Controller tab and select Flash lights to make the controller's lights all flash at the same time. Then select Stop flashing and click OK to close the dialog box.*

**Important** *You can decommission a controller by selecting the controller, clicking the right mouse button, and selecting Decommission. The left pane still shows the controller name. This placeholder still contains configuration information, such as I/O Device Tags and assigned modules. Do not delete the controller placeholder. Deleting a controller placeholder will also delete the I/O configuration, including any Device Tags assigned to the controller's I/O.*

## Configuring I/O Channels

The next task is to configure your I/O channels. There are several steps. First you either autosense physically connected cards or add I/O card placeholders using the DeltaV Explorer. Then you enable the channels on the cards and define the Device Tag for each channel. The Device Tags are the names the DeltaV software uses in the control modules to identify the input and output instruments and hardware devices like transmitters, valves, and so on.

In the tank example used in the tutorial, there are four I/O cards installed in the following order: Analog In, Analog Out, Discrete In, and Discrete Out. If you have a real system set up, your I/O cards may not have been installed in this order—you may not even have some of these card types. Therefore, to be able to do the tutorial I/O configuration exercises, you will need to configure a controller placeholder, as described in the previous section. You can learn the general I/O card configuration steps by reading this section.

Each I/O card has eight channels, not all of which will necessarily be used. The Device Tags for the tank process examples are listed in the following table.

*Table 8-2 Device Tags for the Tank Process Example*

I/O Card	I/O Card Type	Channel	Channel Type	Device Tag	Description
C01	Analog In, 8 Ch, 4-20 mA, HART	CH01	Analog In	LT-1	Level transmitter
		CH02	Analog In	FT-1	Flow transmitter
C02	Analog Out, 8 Ch, 4-20 mA	CH02	Analog Out	FY-1	Regulatory valve
C03	Discrete In, 8 Ch, 24 VDC, Isolated	CH01	Discrete In	XI-1	Confirm motor contact
		CH02	Discrete In	LSC-1	Limit switch-closed
C04	Discrete Out, 8 Ch, 24 VDC, High Side	CH01	Discrete Out	XV-1	Block valve
		CH02	Discrete Out	ZX-1	Motor start contact

Usually, the I/O cards are already downloaded and autosensed when you define the controller node and you can go to the procedure for configuring the first channel on the first I/O card.

However, if you need to add a card or a placeholder, use the following procedure.



**To add an I/O card (or placeholder)**

1. In the DeltaV Explorer, select System Configuration | Physical Network | Control Network | CTRL1 | I/O.
2. Click the right mouse button and select New Card from the menu.  
The Add Card dialog appears.
3. Type a description for the card (such as Analog Input) and confirm or change the slot position.
4. Select a Card class from the top pull down list. (The first card is an Analog Input card.)
5. Select a Card type from the second pull down list. (The first card is 8 Channel, 4-20mA, HART).



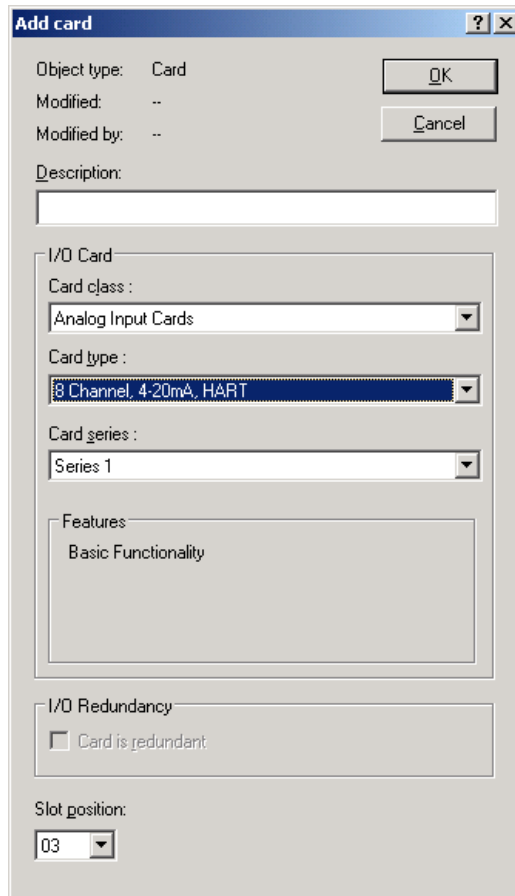

6. Click OK.
7. Repeat the procedure to add the remaining three cards, using the information from the table.



## To configure the first channel on the first I/O card

1. In the DeltaV Explorer, select System Configuration | Physical Network | Control Network | CTLR1 | I/O.

The right pane lists the I/O cards.

2.  Click the I/O configuration button on the toolbar (or click the right mouse button and select Configure I/O from the menu).

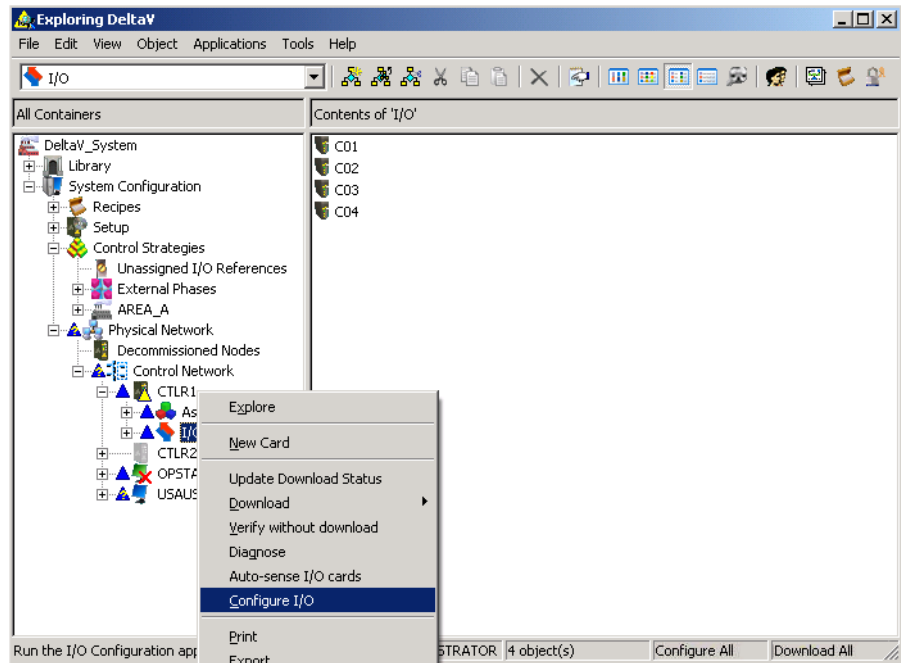

The I/O Configuration window opens, displaying a list of the eight channels available on all the I/O cards. The default channel names are CH01 through CH08.

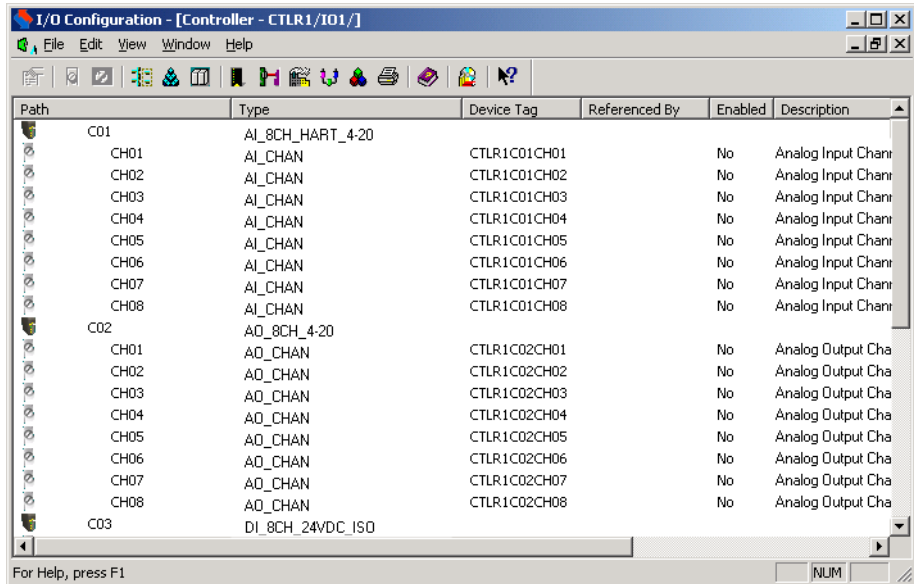

3. For the first card (C01), select CH01, the first channel.
4. Double-click CH01 (or click the right mouse button and select Properties from the menu).  
The Channel Properties dialog box appears.
5. Select Enabled.
6. Enter a description of the channel, for example, Level Transmitter.
7. Enter a Device Tag in the Device Tag field, for example, LT-1.

The Channel Properties box now looks like this:

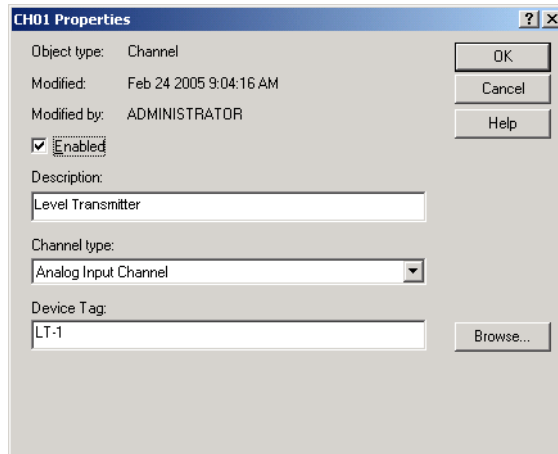

8. Click OK.



### To configure the remaining cards and channels

1. Repeat the procedure (steps 3 through 8), substituting the appropriate information from the table.

### Tips

*To enable a contiguous group of channels, hold down the Shift key, select the channels, select Properties from the context menu, and click Enable. To enable individual channels, hold down the Ctrl. key, select the channels, select Properties from the context menu, and click Enable.*

*If there is a printer handy, you can print a copy of your I/O configuration by clicking the Print button on the toolbar.*

2. Close the I/O Configuration window by clicking the Close button in the upper right corner (or selecting File | Exit).

---

## Downloading the Controller Configuration

After configuring the I/O cards and channels and assigning the controller licenses, you need to download the controller configuration. (You can only do this for a real controller, not a controller placeholder.) Refer to “Assigning Licenses to Nodes” on page 8-8 for more information.

It is recommended that you not perform any tutorial procedures that involve downloading of configuration information into an operational system without fully considering the impact of these changes.



### **To download the controller configuration**

1. In the DeltaV Explorer, select the controller, click the right mouse button, and select Download | Controller from the menu.
2. Read any messages that appear and select the appropriate response.
3. A window will open to show the progress of the download and give you details about any problems encountered.
4. Click Close.

---

## Setting Up Your First User Account

The first user who logs in to the system starts off with a default user name of Administrator. This person has administration privileges associated with the computer domain as well as full access to all DeltaV functions such as configuring hardware, configuring the process system, making changes to the configuration, and so on.

**Important** *The first user must log in using the Administrator account. The default password for this account is `deltav` (lowercase). The first thing the administrator must do is to change the account password and then change the passwords on the administrator accounts on the other workstations to match this password. Then, the administrator configures the ProfessionalPLUS Workstation and downloads that workstation's configuration.*

Before any other users log in to the system, some thought should be given to the overall user access scheme. If more than just one or two users will be accessing the system, you may want to limit their ability to change the process configuration or perform downloads. To do this you need to set up user names and access privileges in the User Manager.

**Note** *There may also be other default user accounts set up on your system, such as Operator, Supervisor, Maintainer, and Configure. The default passwords for these accounts are `DeltaVO1`, `DeltaVS1`, `DeltaVM1`, and `DeltaVC1`, respectively.*



### To access the DeltaV User Manager

1. If you are the very first user after the workstation has been configured, log in as Administrator.
2. Click Start | All Programs | DeltaV | Engineering | User Manager.

The initial screen of the User Manager application appears.

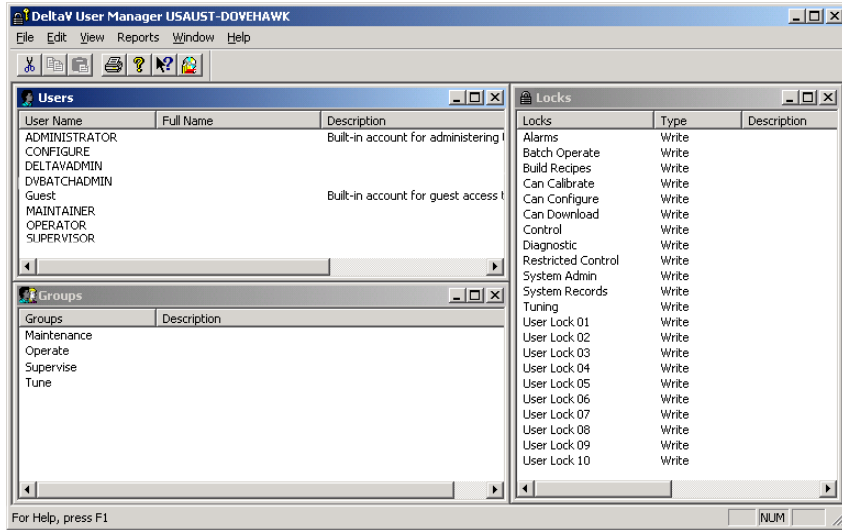

There are a number of default user accounts, including Administrator, DeltaVAdmin, DVBatchAdmin, Configure, Operator, Supervisor, Maintainer, and Guest. Only Administrator has full privileges.

**Important** *Users should not use the DeltaVAdmin or DVBatchAdmin accounts. They are for internal systems use only. You must use the ServPwd.exe utility to change the passwords for these accounts. Refer to the DeltaV User Manager and DeltaV Security topic in DeltaV Books Online for more information on this utility.*



To learn more about User Manager, particularly the specifics of how to limit access to plant areas and grant configuration/download privileges, read the online help for this system. Context sensitive help (related to specific fields) is also available by clicking the What's This button and then clicking on a specific field.

---

## Adding a User

The procedure below steps through the basics for adding a new user account.



### To add a new user

1. Click File | New | User.

The New User dialog box appears.

2. Type the Name, usually only the last name, and tab to the next field or click in the next field. Do not press Enter or click the OK button until you have made all your selections for this user account.

### Note

*If you press Enter, the new user account is created with all the default settings of Windows and DeltaV Account types, but no Download or Configure privileges. To add these privileges, you need to edit the user account properties by clicking on the user's name and selecting File | Properties.*

3. Type the Full Name and tab to the next field.
4. You must enter a password and inform the person of the password.
5. Confirm the password in the next field.
6. Select both Account Types.



---

DeltaV accounts are global. Windows accounts are specific to each workstation. A user's DeltaV account is only usable on a workstation when the Windows account is also enabled for that user on the workstation. You must enable a Windows account for each DeltaV user on every workstation on which that user runs the DeltaV system.

7. Click the Advanced tab.

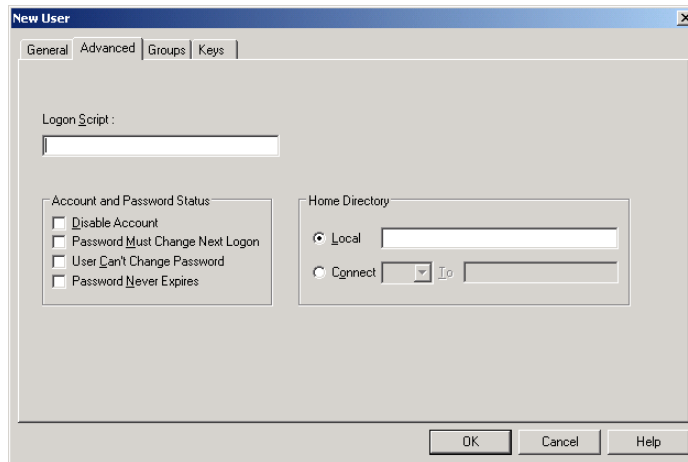

8. Fill in any other information as appropriate for your usage environment.
9. If the user should have Download or Configure privileges, click the Keys tab and add these privileges. (These tabs are described briefly below.)
10. Click OK.
11. Close the User Manager application.

## The Groups and Keys Tabs

The Groups tab is where you can assign the user to a user group that has predefined access privileges. The Keys tab is where you can restrict or grant access to control module parameters and fields. The locks may be for individual plant areas or across all plant areas. You do not need to be concerned about either of these tabs until you have more of your system set up. At some point, however, you will have to specify in detail the locks and groups. Refer to the Online Help for the User Manager for more information on how to do this.

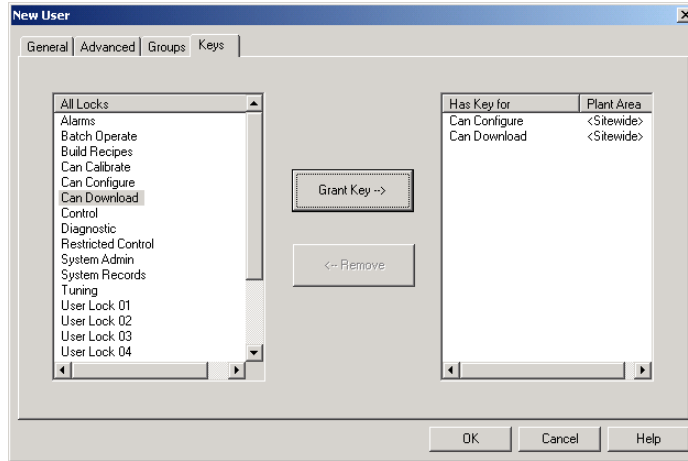

## Downloading the Workstation

After you have made your changes in the DeltaV User Manager, you need to download the workstation.



### To download the workstation

1. In the DeltaV Explorer, select the workstation, click the right mouse button, and select Download | Setup Data from the menu.
2. Answer yes when asked if you want to continue.
3. A window will open to show the progress of the download and give you details about any problems encountered.

Congratulations. You have finished the Physical Network part of your System Configuration and set up your user account. Now you are ready to start configuring the Control Strategy.

At this point you can go to Chapter 3, Learning About the DeltaV Explorer. Then you can create a plant area, which will be the logical container for your control strategy, and create the control modules.

---

# Glossary

Alarm	Alarms alert the operator that a particular event has occurred. You define the types of alarms for your system configuration and the sound that the alarm makes when the event occurs. For example, you could define a HIGH alarm for a specific level on a tank and have the system inform the operator by playing a.WAV (audio) file.
Algorithm	A set of logical steps for solving a problem or accomplishing a task. The module's algorithm defines how the module behaves.
Areas	A logical division of a process control system. Areas typically represent plant locations or main processing functions.
Books Online	A DeltaV application that includes the content of the paper documentation plus theory of operation, configuration planning, and application-specific and system-wide reference information.
Composite	A block in an algorithm that is made up of two or more blocks. A composite can contain function blocks or sequential function charts.
Controller	The DeltaV system device that runs the algorithms to control the process equipment and communicates the process data to the operator workstation.
Database	A collection of data organized for rapid search and retrieval. The DeltaV database allows you to make on-line and off-line changes to your configuration.
Decommission	To take a controller out of service, usually to replace a failed controller. This resets the IP address to the default address and resets the controller's configuration. (You should not delete a controller placeholder that contains configuration information when you decommission a controller.)
Debug	To find and eliminate problems with an installed module by stepping through the algorithm and examining values.
DeltaV Explorer	A navigation tool that provides a unique view of your system. It allows you to see the hierarchy of areas, nodes, and modules and to move to different areas, nodes, and modules. The Explorer is especially useful for copying and moving modules to new nodes using its drag-and-drop capability.

---

Device Signal Tag (DST)	A Device Signal Tag consists of a Device Tag and a specific signal from that device.
DeltaV Workstation	A personal computer running the Windows operating system. One workstation can handle as many as 512 I/O channels from four different controllers.
Device Tag	Device Tags represent the instruments, valves, and other field devices in your DeltaV system.
Dynamo	Graphic objects stored in a library that you use to create pictures in the DeltaV Operate application. Many dynamos are available that represent modules, devices, or characteristics of your system.
Event	A noteworthy occurrence in your process or system. Typically, you want the system to react to and record an event.
Function Block	A logical processing unit of software that defines the behavior of an algorithm for a particular module.
Function Block Diagram (FBD)	A diagram that contains multiple function blocks.
History	A chronological record of events, including the settings and changes made to a module. This record of events can be referenced to gain information about a particular run or lot of the product, or to show that the process complied with quality guidelines or government regulations.
Hub	A device in a network that consolidates control network connections and routes communications. All communications devices on a hub-based network connect to one or more hubs.
Input/Output (I/O)	Signal reception and transmission or signal interfacing. Input, for a process control device, involves accepting and processing signals from field devices. Output, for a process control device, involves converting commands into electrical signals to field devices.
I/O Carrier	The assembly that provides power and communication connections for the DeltaV I/O Interface Modules and termination blocks.
Library	A repository for objects that are intended to be reused. The library in the DeltaV system contains modules, function blocks, composites, and items that the user creates for reuse.

---

Module	A reusable configuration structure that focuses on process equipment. Modules link algorithms, conditions, alarms, displays, history, and other characteristics together for a particular piece of equipment so that you can use modules to develop a control strategy. The library modules have all the necessary characteristics defined for you, but you can customize them for your particular application.
Node	A device (either a DeltaV controller or workstation) on the control network.
Open Database Connectivity (ODBC)	An open, vendor-neutral interface for database connectivity that provides access to a variety of personal computer, minicomputer, and mainframe systems.
Operator	A person who supervises and controls the running process using the DeltaV Operate application in run mode to monitor and set process values.
Parameter	The name of a logical grouping of data such as SP or PV. Each element of data within the group is referred to as a field. A user with the appropriate privileges can modify parameters off-line or on-line to affect the current process.
Process	A collection of physical devices and methods used in the production or manufacturing of a product.
Record	A collection of data (such as date/time, parameter, node, area, level, and so on) for a single event. Records, which can be copied, printed, and exported, are presented as rows in the Process History View program.
Sequential Function Chart (SFC)	A diagram that defines the sequence of events with steps, transitions, and actions.
Step	An element of a sequential function chart that contains a set of actions. A step is either active or inactive.
Universal Naming Convention (UNC) Name	Used when naming a location on your DeltaV system (for example with database locations or host machines) the UNC name is the universal naming convention name. It is a full Windows name of a resource on a network. The UNC conforms to \\machine name\sharename syntax, where machine name is the name of the physical computer and the sharename is the name of the shared resource on the machine to which you are pointing or looking. UNC names of directories or files can also include the directory path under the sharename, with the following syntax: \\machine name\sharename\directory\filename.



---

# Index

## A

- Action in SFC
  - qualifier 4-47
  - type 4-47
- Adding history collection 4-25
- Adding user accounts 8-28
- Administrator account 8-1, 8-28
- Alarm
  - definition 1-4
- Alarm Banner window 5-2
- Alarm View
  - in Control Studio 4-6
- Alarms
  - acknowledging 6-8
  - modifying 4-30
- Algorithm
  - definition 1-3
- Area
  - definition 1-4
- Assigning modules to a controller 4-16
- Auto-Update Service 1-7

## B

- Background color of pictures 5-13
- Batch History View 1-14
- Batch Operator Interface 1-15
- Books Online 1-20
- Boolean Fan In block 4-32
- Browse parameters 5-15
- Browsing for a module template 4-9

## C

- Command driven algorithm
  - definition 1-3
- Common configuration parameter filter 4-11
- Condition blocks 4-32
  - deleting excess 4-34
- Configuration Assistant 1-7
- Configuration floppy disk
  - creating 8-15
- Configure mode
  - using DeltaV Operate in 5-1
- Configuring
  - additional workstations 8-12
  - DeltaV workstations 8-2
  - I/O channels 8-21
  - the Controller Node 8-17
- Connecting function blocks 4-26
- Context menus 3-7
- Context-sensitive help 1-19
- Continuous Historian Administration 1-8
- Continuous Historian Excel Add-In 1-18, 7-13
- Control modules
  - assigning displays to 4-15
  - assigning to a controller 4-16
  - copying from the library 4-4
  - creating 4-1
  - creating from scratch 4-20
  - definition 1-3
  - finishing steps 4-15
  - installing 4-53
  - saving 4-17
  - verifying 4-18
- Control Studio 1-8, 4-5
  - views 4-5
- controller

---

- revision 8-18
- Controller placeholder
  - creating 8-17
- Controller Software
  - licensing 8-4
- Controller Upgrade Utility 1-17
- Controllers
  - downloading 8-27

**D**

- Data links 5-14
  - creating 5-16
  - for loop output 5-21
  - for loop process value 5-21
  - for loop setpoint 5-20
  - for motor setpoint 5-22
  - for tank level 5-17
- Data Source Browser 5-15
- Database
  - definition 1-4
- Database Administration 1-9
- Decommissioned controller Glossary-1
  - configuring 8-20
  - dragging to the control network 8-20
- Default Arrangement
  - of Control Studio views 4-5
- Default password 8-1, 8-28
- Default user accounts 8-29
- DeltaV Explorer 1-9, 3-1
  - navigating 3-3
  - opening 3-2
  - view options 3-3
- DeltaV Inspect 1-12
- DeltaV licenses
  - assigning to nodes 8-8
  - loading 8-6
  - using 8-4
- DeltaV Neural 1-12

- DeltaV Operate 6-1
  - Configure mode 1-10
  - navigating 5-5
  - opening in run mode 5-7
  - Run mode 1-15
- DeltaV Predict 1-13
- DeltaV Simulate Suite 1-14
- DeltaV Tune 1-14
- Detail display 4-15
- DevData.cfg file 8-16
- Device Control function block 4-32
- Device Signal Tag
  - definition 1-4
- Device Tags 4-11
  - browsing 4-13
  - definition 1-4
  - for tank process 8-21
- Diagnostics 1-15
- Diagram View
  - Control Studio 4-6
- Display hierarchy 5-3
- Display History
  - defining in user.glb file 5-4
- Documentation conventions
  - DeltaV Explorer 3-3
- Downloading
  - controllers 8-27
  - workstations 8-11, 8-32
- Dynamic properties 5-14
- Dynamo set
  - pasting from 5-26
- Dynamos 5-24

**E**

- Engineering Units
  - setting for LI-101 module 4-23



---

Equipment modules  
  definition 1-3

Excel Add-In 1-17, 7-10

Explorer  
  see DeltaV Explorer

Expression Editor  
  specifying conditions with 4-36  
  specifying SFC actions 4-48

**F**

faceplate picture 4-15

FIC-101  
  creating 4-27  
  modifying 4-28

Fill styles 5-13

Filtering parameters 4-7, 4-11

Finishing steps for control modules 4-15

FlexLock 1-10

Function block templates 3-4

Function blocks  
  adding to diagram 4-21  
  connecting 4-26  
  definition 1-3

**G**

Graphics wizards  
  See Dynamos

Guardian application 1-17

**H**

Hardware 1-1

Help  
  context-sensitive 1-19

Help system  
  online 1-18

Hierarchy View  
  Control Studio 4-6

History Collection 7-1

History collection  
  adding 4-25

**I**

I/O card  
  adding 8-22

I/O card placeholder  
  creating 8-22

I/O channels  
  configuring 8-21

Installing  
  setup data 8-32

**L**

LI-101  
  creating 4-20  
  saving 4-27

Library  
  definition 1-3

Library templates  
  exploring 3-4

License folder  
  location of 8-7

License Pack 1-2

Licenses  
  controller software 8-4  
  redundant controllers 8-6  
  system software 8-4  
  workstation software 8-5

Line styles 5-13

Links 5-14

Loading DeltaV licenses 8-6

Logical function blocks 4-32

Login  
  as System Administrator 8-28

---

## M

- Main History 6-3
- Main template 5-3
  - selecting 5-8
  - standard buttons 6-5
- Main window 5-2
- Maximizing Control Studio windows 4-33
- Minimizing applications 4-27
- Modes 6-8
  - for loops 6-8
- Modifying alarms 4-30
- Module templates
  - browsing 4-9
- Modules
  - definition 1-3
- MTR-101
  - creating 4-4
  - modifying 4-32

## N

- Named sets 4-40, 4-43
  - creating 4-43
- Navigating
  - in DeltaV Explorer 3-3
  - in DeltaV Operate 5-5
- Network time 3-7
- network time 3-7
- Node
  - definition 1-4

## O

- OPC Mirror 1-18
- OPC server 1-17
- Operating environment
  - description 5-1
- Operator displays

- creating 5-1

- Operator System Configuration Utility 1-17

- Overview picture 5-4

## P

- Palette in Control Studio Diagram View 4-6

- Parameter
  - browser 5-15
  - filtering 4-7
  - promoted 4-20

- Parameter filtering 4-11

- Parameter References
  - in DeltaV Operate (run mode) 5-14

- Parameter tagnames 4-38

- Parameter View
  - Control Studio 4-6

- Parameters
  - module-level 4-24

- Password
  - default 8-1, 8-28

- Picture files
  - saving 5-9

- Pictures 5-1
  - changing the background color 5-13
  - setting previous and next 5-32

- PID control loop module
  - creating 4-27

- Placeholder for controller
  - creating 8-17

- Placeholder for I/O card
  - creating 8-22

- Plant areas
  - creating 4-2
  - definition 1-4

- Primary Control picture 4-15

- Process History View 1-16

---

Promoted parameter 4-20

## Q

Quick Edit 5-6

## R

Recipe Studio 1-11

Redundant Controllers  
licensing 8-6

Registration Utility 1-17

Rest Layout  
in DeltaV Operate 6-2

Restoring applications 4-27

Run mode  
using DeltaV Operate in 6-1

## S

Saving modules 4-17

Scenario  
tank process 2-2

Sequential Function Chart 2-3  
creating 4-42  
definition 1-3

Set/synchronize network time 3-7

Setup data  
installing 8-32

Start menu  
using the 1-6

State driven algorithm  
definition 1-3

System Alarm Management 1-11

System Identifier 1-2, 8-11

System Preferences 1-11

System software  
licensing 8-4

System time 3-7

## T

Tagnames  
in Control Studio 4-38

Terminology 1-3

Text (A) button 5-20

Toolbar window 5-2

Toolbox 5-10  
moving and resizing 5-12

Transitions in SFC 4-49

Trend links 5-14, 5-30

## U

Unit modules  
definition 1-3

Up One Level button 5-18

User accounts  
adding 8-28  
default 8-29

User Manager 1-11, 8-28

UserSettings file 5-4

## V

Verifying modules 4-18

View  
Control Studio 4-5

View options  
in DeltaV Explorer 3-3

## W

What's this?  
button 1-19  
example 4-21

Windows taskbar 4-5, 4-27

Wizard  
Excel 7-11

Workstation Configuration 1-17

---

starting 8-3

Workstation Software  
licensing 8-5

Workstations  
configuring 8-2, 8-12  
downloading 8-11, 8-32

World Wide Web page 1-21

## **X**

XV-101  
creating 4-8  
modifying 4-11