

# ControlNet PLC-5 Programmable Controllers



## User Manual

(Catalog Numbers  
1785-L20C15, 1785-L40C15,  
1785-L46C15, 1785-L80C15)

## Important User Information

Solid state equipment has operational characteristics differing from those of electromechanical equipment. Safety Guidelines for the Application, Installation and Maintenance of Solid State Controls (publication SGI-1.1 available from your local Rockwell Automation sales office or online at <http://literature.rockwellautomation.com>) describes some important differences between solid state equipment and hard-wired electromechanical devices. Because of this difference, and also because of the wide variety of uses for solid state equipment, all persons responsible for applying this equipment must satisfy themselves that each intended application of this equipment is acceptable.





In no event will Rockwell Automation, Inc. be responsible or liable for indirect or consequential damages resulting from the use or application of this equipment.

The examples and diagrams in this manual are included solely for illustrative purposes. Because of the many variables and requirements associated with any particular installation, Rockwell Automation, Inc. cannot assume responsibility or liability for actual use based on the examples and diagrams.

No patent liability is assumed by Rockwell Automation, Inc. with respect to use of information, circuits, equipment, or software described in this manual.

Reproduction of the contents of this manual, in whole or in part, without written permission of Rockwell Automation, Inc., is prohibited.

Throughout this manual, when necessary, we use notes to make you aware of safety considerations.

<b>WARNING</b> 	Identifies information about practices or circumstances that can cause an explosion in a hazardous environment, which may lead to personal injury or death, property damage, or economic loss.
<b>IMPORTANT</b>	Identifies information that is critical for successful application and understanding of the product.
<b>ATTENTION</b> 	Identifies information about practices or circumstances that can lead to personal injury or death, property damage, or economic loss. Attentions help you identify a hazard, avoid a hazard, and recognize the consequence
<b>SHOCK HAZARD</b> 	Labels may be on or inside the equipment, for example, a drive or motor, to alert people that dangerous voltage may be present.
<b>BURN HAZARD</b> 	Labels may be on or inside the equipment, for example, a drive or motor, to alert people that surfaces may reach dangerous temperatures.

Allen-Bradley, ControlLogix, Data Highway Plus, DH+, FLEX I/O, PLC-2, PLC-3, PLC-5, Rockwell Automation, RSLinx, RSLogix, RSLogix 5000, RSLogix 5, RSNetWorx, RSNetworx for ControlNet, SLC, and TechConnect are trademarks of Rockwell Automation, Inc.

Trademarks not belonging to Rockwell Automation are property of their respective companies.

---

## Summary of Changes

The information below summarizes the changes to the ControlNet PLC-5 Programmable Controllers User Manual.

To help you find new and updated information, look for the revision bars as shown to the left of this paragraph.

### Revised Information

See the table in the Using the ControlNet PLC-5 Processor in a ControlNet I/O System section on page 2-31 to see the revision to information about the ControlLogix ControlNet Bridge.

### Software and Hardware Requirements

Use the following table to understand specific features that are only available with specific versions and releases of software and PLC-5 processors:

If you want this feature:	You need both of these versions of software:		And this PLC-5 processor (ControlNet Series F, Revision A or later)
	RSLogix 5	RSNetWorx:	
Standard functionality	2.2 or later	1.8 or later	all
Hot Backup (1771 and FLEX I/O)	3.21 or later	1.8 or later	PLC-5/40 or -5/80
Multicast Outputs	3.21 or later	3.0 or later	PLC-5/20, -5/40 or -5/80
SLC I/O (also with Hot Backup)	5.0 or later	3.0 or later	PLC-5/40 or -5/80

## Notes

## Installing Your ControlNet PLC-5 Processor

### Chapter 1

Using This Chapter .....	1-1
Prevent Electrostatic Discharge .....	1-2
Identifying ControlNet PLC-5 Processor Components .....	1-3
Before You Install the Programmable Controller .....	1-5
Install or Remove the Battery .....	1-6
Setting the I/O Chassis Backplane Switches .....	1-9
Setting the I/O Chassis Configuration Plug .....	1-10
Installing Keying Bands for the Processor .....	1-10
Selecting the DH+ Station Address of Channel 1A .....	1-11
Specifying the Serial Interface of Channel 0 .....	1-12
Selecting the ControlNet Network Address of Channel 2 .....	1-12
Inserting/Removing the Processor into/from the I/O Chassis .....	1-13
Installing a Remote I/O Link .....	1-13
Installing a DH+ Link .....	1-15
Connecting to a ControlNet Network .....	1-17
Connecting a Programming Terminal .....	1-19
DH+ Connection .....	1-19
Serial Channel .....	1-20
ControlNet Connection .....	1-21
Selecting Appropriate Cables .....	1-22
Serial Cables .....	1-22
DH+ Programming Cables .....	1-23
Remote I/O Cables .....	1-23
ControlNet Cables .....	1-23

## Planning to Use Your ControlNet PLC-5 Processor

### Chapter 2

Using This Chapter .....	2-1
Understanding ControlNet I/O .....	2-1
Scheduled Data-Transfer Operations on a ControlNet Network .....	2-2
Unscheduled Data-Transfer Operations on a ControlNet Network .....	2-4
Using I/O Forcing Operations .....	2-7
Using Immediate Data-Transfer Operations .....	2-8
Using Process Control Sample Complete .....	2-9
Clearing the PCSC New Data and PCSC Overflow Bits .....	2-11
Considerations When Using PCSC .....	2-11
Understanding Scheduled Connection Types .....	2-11
Allowable Scheduled Connection Type Combinations .....	2-12
Multiple Processors Can Control I/O .....	2-13

- Understanding Multicast Inputs . . . . . 2-14
- Understanding Multicast Outputs . . . . . 2-14
  - Using Multicast Outputs . . . . . 2-15
- Understanding ControlNet I/O Mapping . . . . . 2-16
  - Reserving Space for Non-ControlNet I/O. . . . . 2-16
    - Processor-Resident Local I/O . . . . . 2-16
    - Remote I/O. . . . . 2-17
  - Supported ControlNet I/O Sizes . . . . . 2-18
    - Discrete I/O Data Transfer Mapping . . . . . 2-19
    - Non-Discrete I/O Data Transfer Mapping . . . . . 2-19
    - 1771 Modules . . . . . 2-20
    - 1747 Modules . . . . . 2-20
    - 1794 Modules . . . . . 2-20
    - Other ControlNet Processors . . . . . 2-21
- Using I/O Mapping Techniques. . . . . 2-21
  - Understanding Discrete Mapping . . . . . 2-22
  - Optimizing the I/O Image Table . . . . . 2-23
    - Optimizing the I/O Image Table without Slot Complementary . . 2-23
    - Optimizing the I/O Image Table with Slot Complementary. . . . 2-27
  - Summary. . . . . 2-29
- Using the ControlNet PLC-5 Processor in a ControlNet I/O System . . 2-31
  - Distributed Keeper Functionality. . . . . 2-33
- Converting from a Non-ControlNet Remote I/O System  
to a ControlNet I/O System . . . . . 2-34
- Converting from ControlNet Phase 1.0 or 1.25  
to ControlNet Phase 1.5 . . . . . 2-35

**Understanding the ControlNet System Software**

**Chapter 3**

- Configuring and Programming Your ControlNet System . . . . . 3-1
- Using ControlNet Message Instructions . . . . . 3-1
  - I/O Configuration Utility . . . . . 3-2
  - Uploading and Downloading Software Projects. . . . . 3-3
  - Using RSNetWorx to Perform Verification Activities. . . . . 3-4
- For More Information . . . . . 3-5

**Programming Your  
ControlNet System****Chapter 4**

Using This Chapter . . . . .	4-1
Using ControlNet Message Instructions . . . . .	4-1
Multihop Messaging Via the MSG Instruction . . . . .	4-2
Option to Close Communication Connection when MSG is Done . . . . .	4-3
Understanding the ControlNet PLC-2 Compatibility File . . . . .	4-3
Using the ControlNet I/O Transfer Instruction . . . . .	4-3
Sending Continuous Messages. . . . .	4-5
1771 ControlNet Transfers in PIs and STIs. . . . .	4-5
Using ControlNet Immediate Data Input and Output Instructions. . . . .	4-6
Using Selectable Timed Interrupts with a Program on a ControlNet Network . . . . .	4-9
Recovering from Major Fault 200 and 201 . . . . .	4-9

**Monitoring and Troubleshooting  
Your ControlNet System****Chapter 5**

Using This Chapter . . . . .	5-1
Using the General Status Indicators . . . . .	5-1
Using the ControlNet Status Indicators . . . . .	5-3
Using the DH+/RIO Status Indicators . . . . .	5-5
Monitoring ControlNet Configuration and Status. . . . .	5-6

**Processor Specifications****Appendix A****Processor Status File****Appendix B**

S:0 - S:2 . . . . .	B-1
S:3-10 . . . . .	B-2
S:11 . . . . .	B-3
S:12 . . . . .	B-4
S:13-S:24 . . . . .	B-11
S:26-S:35 . . . . .	B-12
S:36-S:78 . . . . .	B-13
S:79-S127 . . . . .	B-15

**ControlNet Instruction Set****Appendix C**

ControlNet I/O Transfer Instruction . . . . .	C-1
Message Instructions on a ControlNet Network . . . . .	C-1
Immediate Data I/O Instructions . . . . .	C-2
Instruction Timing and Memory Requirements . . . . .	C-2

**ControlNet I/O Map-Entry  
Status Words and  
Error Messages**

**Appendix D**

I/O Map-Entry Status Words . . . . . D-1  
Error Codes . . . . . D-4

**Fault Codes**

**Appendix E**

Clearing Faults. . . . . E-1  
Additional Major Fault Codes . . . . . E-2

**ControlNet Diagnostics  
File Layout**

**Appendix F**



---

# Preface

## Introduction

This manual describes how to install your programmable controller and how to plan for, configure, and use the features of a 1785-L20C15, 1785-L40C15, 1785-L46C15 or 1785-L80C15 programmable controller that are unique to the ControlNet network.

When we refer to ControlNet PLC-5 programmable controllers (or “processors”) in this manual, we mean the phase 1.5 programmable controllers:

- Catalog number 1785-L20C15 (or PLC-5/20C)
- Catalog number 1785-L40C15 (or PLC-5/40C)
- Catalog number 1785-L46C15 (or PLC-5/46C)
- Catalog number 1785-L80C15 (or PLC-5/80C)

For detailed information about features that the ControlNet PLC-5 processors share with Ethernet and Enhanced processors, see the Enhanced and Ethernet PLC-5 Programmable Controllers User Manual, publication 1785-6.5.12.

## Audience

The information in this manual is intended for engineers and technicians who are installing, programming, and maintaining a control system that includes a ControlNet PLC-5 programmable controller.

You should have a background in control-system applications and a basic knowledge of:

- programmable real-time control systems
- the PLC-5 control system
- your operation’s required systems and applications

## Terminology

Term	Description
Actual Packet Interval (API)	the actual time it takes for the ControlNet network to update the requested data. The largest binary multiple of the Network Update Time (NUT), smaller or equal to the Requested Packet Interval (RPI). For more information, see Scheduled Data-Transfer Operations on a ControlNet Network on page 2-2.
ControlNet network	communication architecture that allows the exchange of data between Allen-Bradley Company, Inc. products and certified third-party products
ControlNet PLC-5 processors	references PLC-5/20C, PLC-5/40C, PLC-5/46C and PLC-5/80C programmable controllers phase 1.5
connection	opened communication path between two nodes on a ControlNet network
DData Input File (DIF)	integer file used by ControlNet PLC-5 processors to store discrete and non-discrete input data. The DIF cannot be forced
Data Output File (DOF)	integer file used by ControlNet PLC-5 processors to store discrete and non-discrete output data. The DOF cannot be forced
discrete I/O data transfer	type of data transfer in which single units of I/O have discrete relationships with values in the processor's data table; uses the processor's input- and output-image tables (I and O files); configured on a per-node basis in the ControlNet I/O map table
frame	single data transfer on a ControlNet link
drop cable	cable that connects a ControlNet node to the trunk cable; integral part of 1786 taps
I/O map table (scanlist configuration)	table that you configure using the programming software to map data from an I/O chassis and other devices on the ControlNet network to particular data table file addresses
keeper	device that stores and distributes ControlNet configuration data to all nodes on the network. A minimum of one keeper device is required on each ControlNet network.
link	collection of ControlNet nodes with unique network addresses in the range of 01-99; segments connected by repeaters make up a link; links connected by bridges make up a network
map table entry (scanlist entry)	one entry in the I/O map table that you configure using the programming software to map data from one I/O chassis or other device on ControlNet to particular data table file addresses
network access port (NAP)	port that provides a temporary ControlNet-network connection through an RJ45 connector
network address	node's address on the ControlNet network
network update interval (NUI)	single occurrence of the ControlNet Network Update Time (NUT)
network update time (NUT)	smallest repetitive time interval in which data can be sent on the ControlNet network
node	port of a physical device connecting to the ControlNet network that requires a network address in order to function on the network; a link may contain a maximum of 99 nodes
non-discrete I/O data transfer	type of data transfer in which blocks of data transferred to or from a single I/O module use integer input and output data table files that you specify; scheduled transfers are configured in the ControlNet I/O map table, unscheduled transfers make use of ControlNet I/O Transfer (CIO) instructions
owner	device that controls the outputs of an adapter
processor	any one of the ControlNet PLC-5 programmable controllers
redundant media	dual-cable system that allows you to receive the best signal over a ControlNet network

Term	Description
repeater	two-port active physical-layer device that reconstructs and retransmits all traffic that it hears on one ControlNet segment to another segment
Requested Packet Interval (RPI)	the maximum time allowed for the ControlNet network to update requested data. The RPI is user-selectable on a per connection basis. For more information, see page 2-2.
scheduled maximum node (SMAX)	the maximum ControlNet node number that can transmit and receive scheduled data
scheduled transfers	deterministic and repeatable transfers that are continuous and asynchronous to the ladder-logic program scan
scheduled connection types	<p><b>rack connection</b> - scheduled connection made from the PLC-5C to I/O adapters to some or all of the discrete I/O on the adapter</p> <p><b>module connection</b> - scheduled connection made from the PLC-5C to I/O adapters to individual modules</p>
segment	trunkline section of ControlNet network with terminators at each end; a segment does not include repeaters; segments connected by repeaters make up a link
tap	component that connects products to the ControlNet trunk cable; a tap is required for each node and for each side of a repeater
terminator	75W resistor—mounted in a BNC plug—placed on each end of a ControlNet segment to prevent reflections from occurring at the ends of the cable
trunk cable	bus or central part of the ControlNet cable system
trunk-cable section	length of trunk cable between any two ControlNet taps
unscheduled maximum node (UMAX)	the maximum ControlNet node number that can transmit and receive unscheduled data
unscheduled transfers	non-deterministic data transfers through ladder-initiated communication or programming devices

## Related PLC-5 Publications

The 1785 PLC-5 programmable-controller and ControlNet documentation is organized into manuals according to the tasks that you perform:

Publication	Publication Number
Enhanced and Ethernet PLC-5 Programmable Controllers User Manual	1785-6.5.12
ControlNet Cable System Planning and Installation Manual	1785-6.2.1
1785-PLC-5 Programmable Controllers Quick Reference	1785-7.1

For more information about 1785 PLC-5 programmable controllers, contact your local Rockwell Automation sales office or distributor.

To view or order these publications online, visit:

[www.literature.rockwellautomation.com](http://www.literature.rockwellautomation.com)

## Related ControlNet Publications

For detailed information about different aspects of planning and installing your ControlNet network, see the following publications:

Publication	Publication Number
ControlNet Coax Cable System Planning and Installation Manual	1786-6.2.1
ControlNet Network Access Cable Installation Instructions	1786-2.6
ControlNet System Overview	CNET-SO001
ControlNet PLC-5 Hot Backup System User Manual	1785-UM024
ControlNet Fiber Planning Installation Guide	CNET-IN001
Industrial Automation Wiring and Grounding Guidelines	1770-4.1
System Design for Control of Electrical Noise	GMC-RM001

To view or order these publications online, visit:

[www.literature.rockwellautomation.com](http://www.literature.rockwellautomation.com)

or contact your local Rockwell Automation sales office or distributor.

## Installing Your ControlNet PLC-5 Processor

### Using This Chapter

Topic	Page
Preventing Electrostatic Discharge	1-2
Identifying the processor components	1-3
What to do before you begin installation	1-5
Installing and disposing of the processor battery	1-6
Setting the I/O chassis backplane switches	1-11
Setting the I/O chassis configuration plug	1-10
Installing keying bands for the processor	1-10
Selecting the Data Highway Plus (DH+) station address of Channel 1A	1-11
Specifying the serial interface for Channel 0	1-12
Selecting the ControlNet network address of Channel 2	1-12
Inserting/removing the processor into/from the I/O chassis	1-13
Installing a remote I/O link	1-13
Installing a DH+ link	1-15
Connecting to a ControlNet network	1-17
Connecting a programming terminal	1-19
Selecting appropriate cables	1-22

For detailed information about installing chassis and adapters, see the Enhanced and Ethernet PLC-5 Programmable Controllers User Manual, publication 1785-6.5.12.

## Prevent Electrostatic Discharge

---

**ATTENTION**

This equipment is sensitive to electrostatic discharge which can cause internal damage and affect normal operation. Follow these guidelines when you handle this equipment:

- touch a grounded object to discharge potential static
  - wear an approved grounding wrist strap
  - do not touch connectors or pins on component boards
  - do not touch circuit components inside the equipment
  - if available, use a static-safe workstation
  - when not in use, store the equipment in appropriate static-safe packaging
-

## Identifying ControlNet PLC-5 Processor Components

Figure 1.1 and Figure 1.2 show the front panels of the ControlNet PLC-5 processors.

Figure 1.1 PLC-5/20C Processor Front Panel

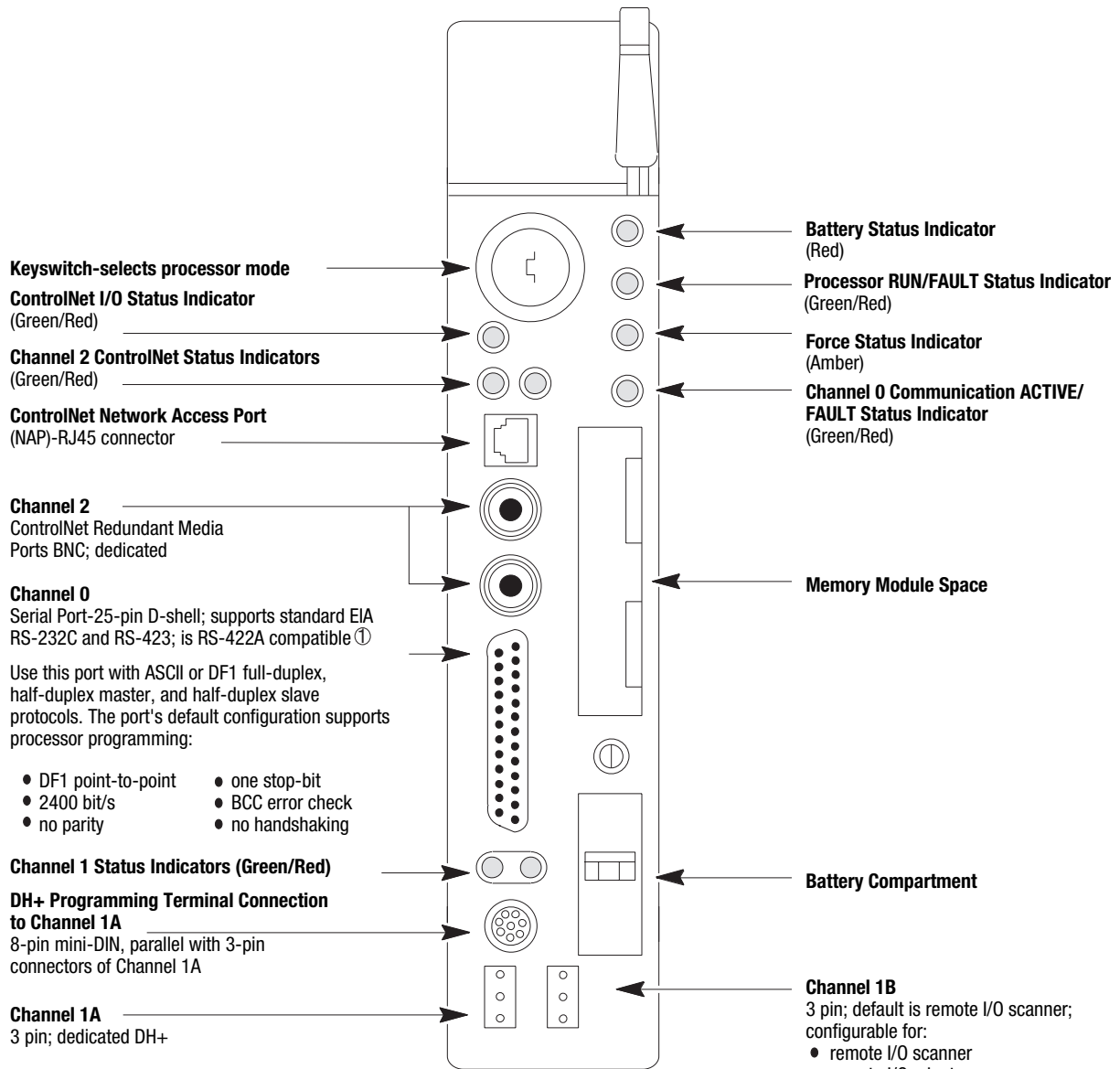

① Channel 0 is optically coupled (provides high electrical noise immunity) and can be used with most RS-422A equipment as long as:

- termination resistors are not used
- the distance and transmission rate are reduced to comply with RS-423 requirements

Figure 1.2 PLC-5/40C, -5/46C, and -5/80C Processors Front Panel

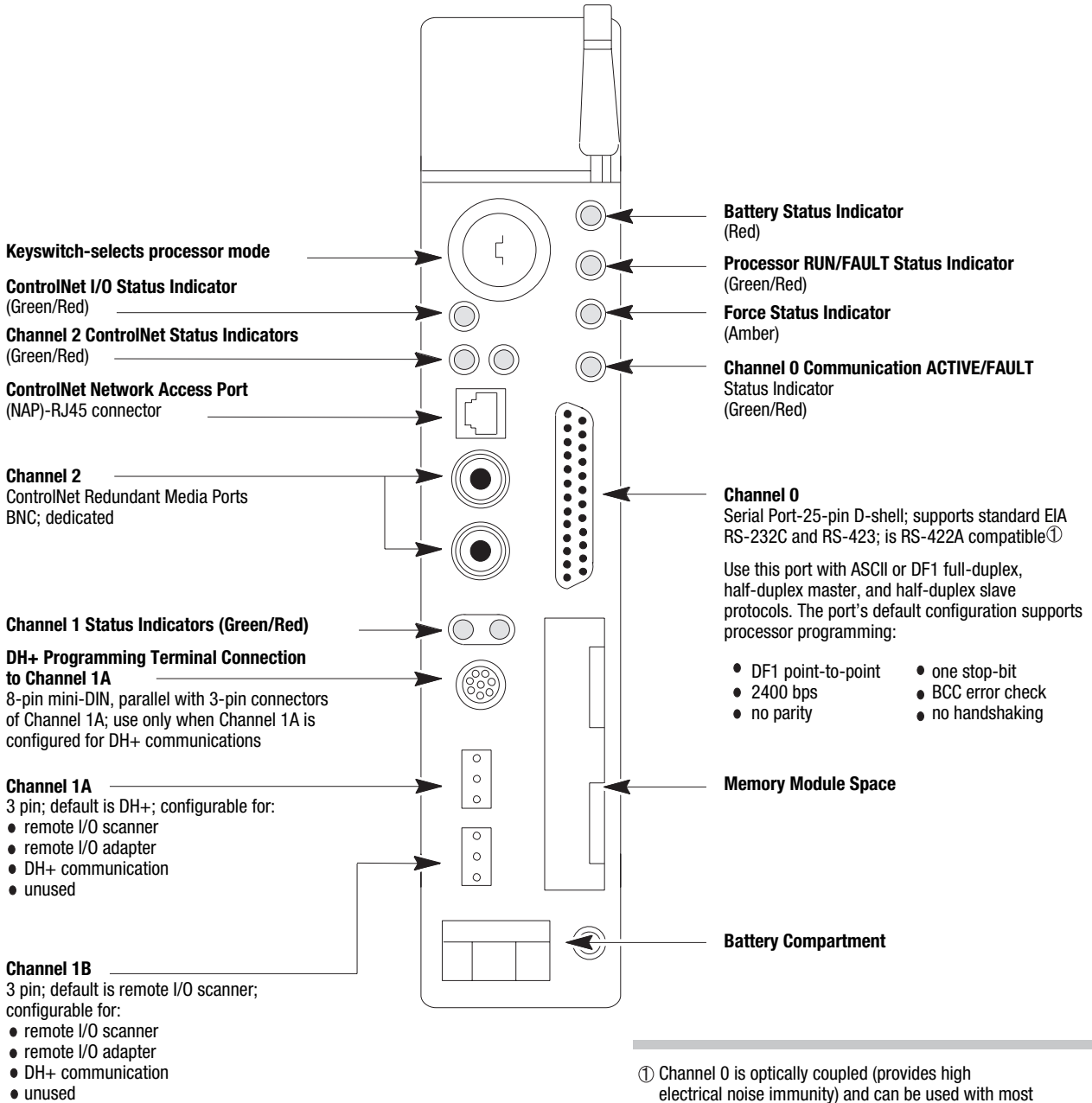

① Channel 0 is optically coupled (provides high electrical noise immunity) and can be used with most RS-422A equipment as long as:



- termination resistors are not used
- the distance and transmission rate are reduced to comply with RS-423 requirements



## Before You Install the Programmable Controller

Before installing your ControlNet PLC-5 processor:

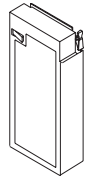
1. Check your processor package, and make sure that you have the following:

 <p>Processor</p>	ControlNet PLC-5 <sup>®</sup> Programmable Controller, 1785-L20C15, -L40C15, -L46C15, or -L80C15	
 <p>Documentation</p>	ControlNet PLC-5 Programmable Controllers Quick Start, publication number 1785-10.6	
Contents of Tray	1	Lithium Battery, 1770-XYC
	1	DIN connector cover
	4	Terminating resistors—150Ω <sup>1</sup>
	2 or 4 <sup>2</sup>	Terminating resistors—82Ω <sup>3</sup>
	2 or 4 <sup>2</sup>	3-pin connectors
	2	Keys
	1	Battery cover with screw
	1	1784-CP7 cable adapter for 1784-CP, -CP5 cables

<sup>1</sup> Identified by four colored bands: brown, green, brown, and gold

<sup>2</sup> Two with a PLC-5/20C processor, four with PLC-5/40C, -5/46C and -5/80C processors

<sup>3</sup> Identified by four colored bands: gray, red, black, and gold

If any items are missing or incorrect, contact your local Rockwell Automation sales office or distributor.

2. Install and connect a chassis and power supply.

Use the following table to find more information about completing these tasks:

Chassis Type	Chassis Document	Power Supply	Power Supply Document
1771-A1B, -A2B, -A3B, -A3B1, -A4B	1771-2.210	1771-P1	1771-2.6
		1771-P2	1771-2.7
		1771-P3	1771-2.111
		1771-P4	1771-2.111
		1771-P4R	1771-5.3
		1771-P4S	1771-2.13
		1771-P5	1771-2.111
		1771-P6R	1771-5.3
		1771-P6S	1771-5.11
		1771-P7	1771-5.56

## Install or Replace the Battery

A 3.0 volt lithium battery (cat. no. 1770-XYC) is included with your processor.

If the LED on the front of the processor indicates BATT, it means that the battery must be replaced. You must use an exact replacement battery (cat. no. 1770-XYC).

---

**ATTENTION**

Lithium battery requirements:

- do not short, recharge, heat above 85° C, disassemble or expose contents to water
- use only the 1770-XYC battery in the processor. DO NOT use any other type or size of battery.

---

**Important:** In non-hazardous environments, it may be possible to replace the battery while the processor is powered so that your programs are maintained in memory. You may lose your programs if you remove the battery when power is removed.

---

**WARNING**

When you connect or disconnect the battery, an electrical arc can occur. This could cause an explosion in hazardous location installations. Be sure that power is removed or the area is nonhazardous before proceeding.

- For safety information on the handling of lithium batteries, including handling and disposal of leaking batteries, refer to *Guidelines for Handling Lithium Batteries*, publication AG-5.4
  - Store batteries in a cool, dry environment. We recommend 25° C with 40% or 60% relative humidity. You may store batteries up to 30 days between -45° - 85° C, such as during transportation. To avoid possible leakage, do not store batteries above 60° C for more than 30 days.
-

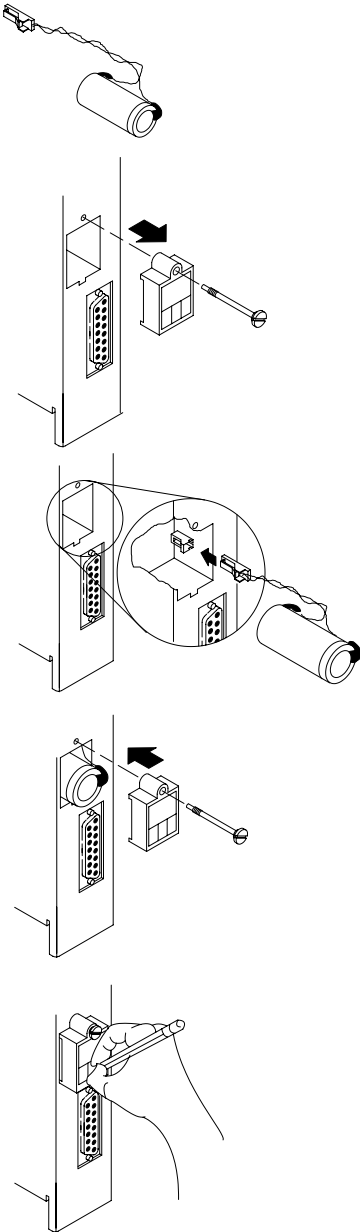

To install or replace the battery:

1. Remove the battery from the shipping bag.
2. Remove the battery cover from the processor.
3. If you are replacing an existing battery, detach the wired clip from the mating connector on the processor and remove the battery.
4. Connect the new or replacement battery by attaching the wired clip to the mating connector on the processor.
5. Place the battery and tuck the wires inside the battery area on the processor.
6. Replace the battery cover.
7. Use a pencil or erasable pen to write the battery installation date on the battery cover.

---

**WARNING**



When you connect or disconnect the battery, an electrical arc can occur. This could cause an explosion in hazardous location installations. Be sure that power is removed or the area is nonhazardous before proceeding.

- For safety information on the handling of lithium batteries, including handling and disposal of leaking batteries, refer to *Guidelines for Handling Lithium Batteries*, publication AG-5.4
  - Store batteries in a cool, dry environment. We recommend 25° C with 40% or 60% relative humidity. You may store batteries up to 30 days between -45° - 85° C, such as during transportation. To avoid possible leakage, do not store batteries above 60° C for more than 30 days.
-

## Estimated Battery Lifetimes

Processor	Temperature	Worst-Case Battery-Life Estimates		
		Power Off 100%	Power Off 50%	Battery Duration <sup>1</sup>
PLC-5/20C	60° C	173 days	346 days	70 hours
	25° C	1.69 years	3.38 years	14.5 days
PLC-5/40C	60° C	92.5 days	185 days	38 hours
	25° C	1.25 years	2.5 years	10.8 days
PLC-5/46C	60° C	92.5 days	185 days	38 hours
	25° C	1.25 years	2.5 years	10.8 days
PLC-5/80C	60° C	80 days	160 days	33 hours
	25° C	1.18 years	2.36 years	10 days

<sup>1</sup> The battery status indicator (BATT) warns you when the battery is low. These durations are based on the battery supplying the only power to the processor—power to the chassis is off—once the status indicator first lights.

## Dispose of a Battery

If you need to dispose of a battery, follow the procedures described in *Guidelines for Handling Lithium Batteries*, (pub. no. AG-5.4).

### ATTENTION



Follow these precautions to prevent the battery from exploding. An exploding battery exposes toxic, corrosive and flammable chemicals and causes burns.

- do not incinerate or expose the battery to high temperatures
- do not solder the battery or leads
- do not open, puncture or crush the battery
- do not charge the battery
- do not short positive or negative terminals together

## Setting the I/O Chassis Backplane Switches

Set the I/O chassis backplane switches using a ball-point pen to set each switch.

**Important:** Do not use a pencil because the tip can break off and short the switch.

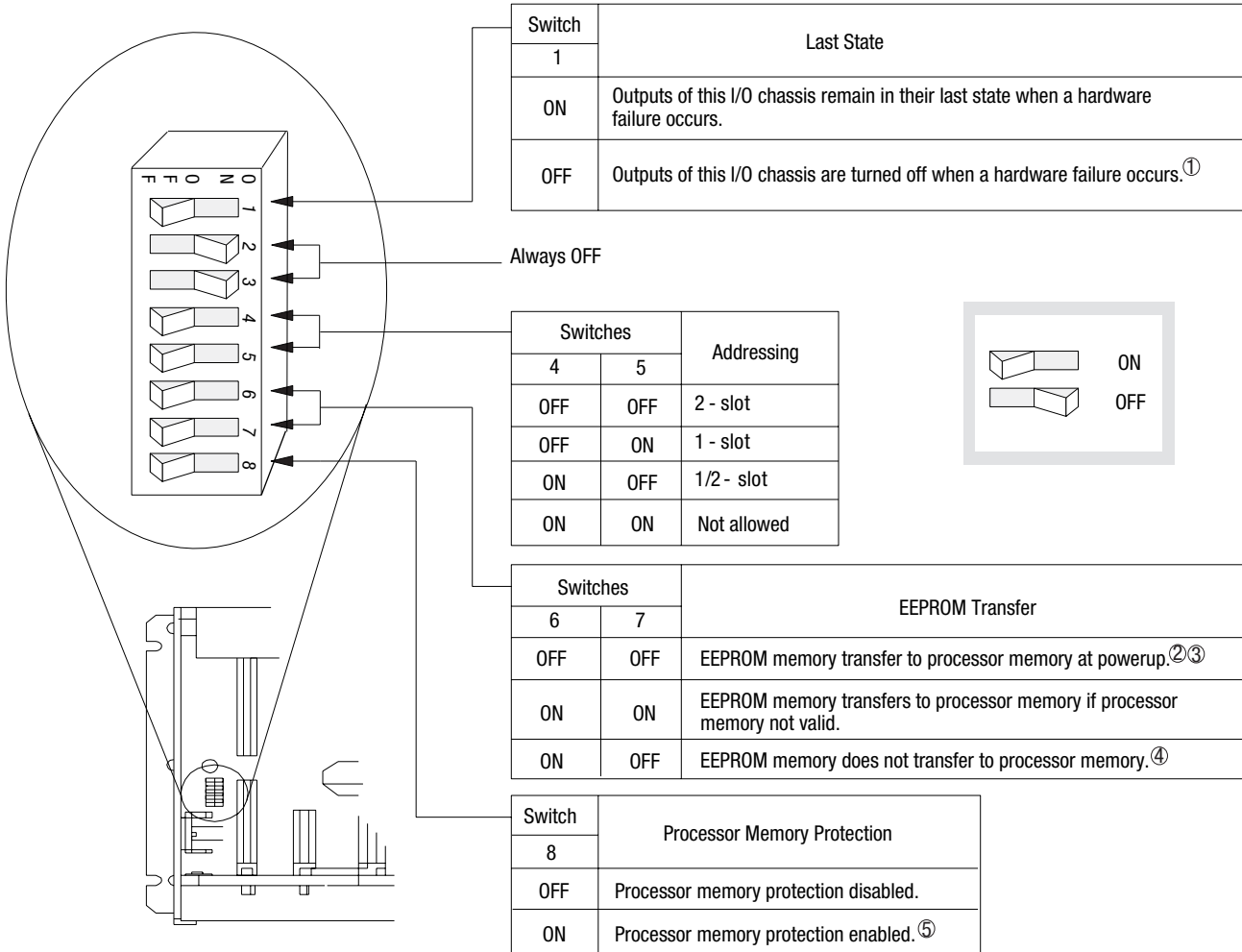

- ① Regardless of this switch setting, outputs are turned off when any of the following occurs:
  - processor detects a runtime error
  - an I/O chassis backplane fault occurs
  - you select Program or Test mode
  - you set a status file bit to reset a local rack
- ② If an EEPROM module is not installed and processor memory is valid, the processor's PROC indicator blinks and the processor sets bit S:11/9 in the major fault status word. To clear this fault, change the processor from Program mode to Run mode and back to Program mode.
- ③ If the processor's keyswitch is set in Remote, the processor enters Remote Run mode after it powers up and has its memory updated by the EEPROM module.
- ④ A processor fault (solid red PROC LED) occurs if processor memory is not valid.
- ⑤ You cannot clear processor memory when this switch is on.

### Setting the I/O Chassis Configuration Plug

Set the I/O chassis configuration plug as follows:

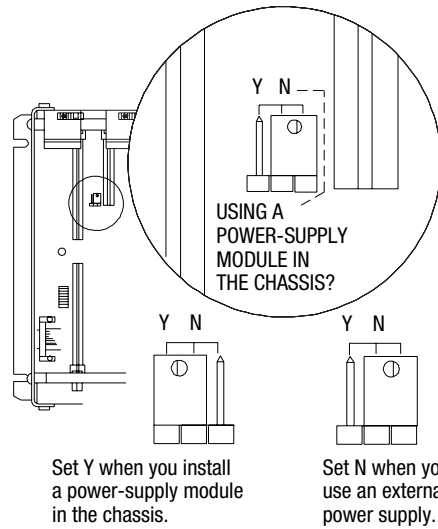

1. Locate the chassis configuration plug (between the two left most slots of the chassis).
2. Set the I/O chassis configuration plug.  
The default setting is N (not using a power-supply module in the chassis).

**Important:** You cannot power a single I/O chassis with both a power-supply module and an external power supply.

17075

### Installing Keying Bands for the Processor

You receive plastic keying bands with each I/O chassis. Insert the keying bands as follows:

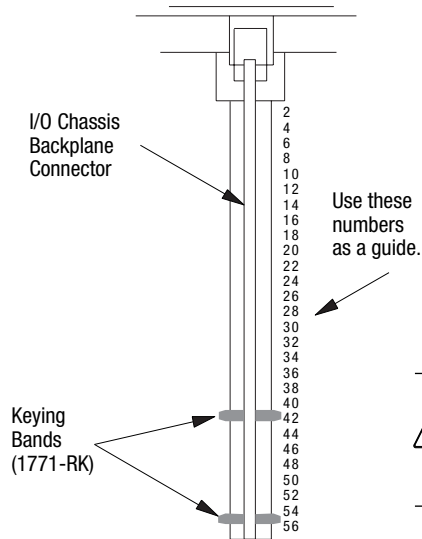

- Install a keying band in the left-most slot between the following pins:
- 40 and 42
  - 54 and 56

**ATTENTION:** A module inserted into a wrong slot could be damaged by improper voltages connected through the wiring arm. Use keying bands to prevent damage to the module.

12062

### Selecting the DH+ Station Address of Channel 1A

To select the DH+ station address of Channel 1A, set the switches of assembly SW1.

Side View of PLC-5/20C, -5/40C, -5/46C, -5/80C Switch Assembly SW1

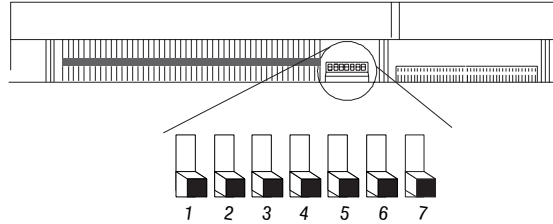

To select:	Set switch:	To:
DH+ Station Number	1 through 6	(See below)
Channel 1A DH+ Configuration	7	on (bottom) 57.6 kbps off (top) 230.4 kbps

 Toggle pushed toward TOP  
 OFF

 Toggle pushed toward BOTTOM  
 ON

DH+ Station Number	Switch					
	1	2	3	4	5	6
0	on	on	on	on	on	on
1	off	on	on	on	on	on
2	on	off	on	on	on	on
3	off	off	on	on	on	on
4	on	on	off	on	on	on
5	off	on	off	on	on	on
6	on	off	off	on	on	on
7	off	off	off	on	on	on
10	on	on	on	off	on	on
11	off	on	on	off	on	on
12	on	off	on	off	on	on
13	off	off	on	off	on	on
14	on	on	off	off	on	on
15	off	on	off	off	on	on
16	on	off	off	off	on	on
17	off	off	off	off	on	on
20	on	on	on	on	off	on
21	off	on	on	on	off	on
22	on	off	on	on	off	on
23	off	off	on	on	off	on
24	on	on	off	on	off	on
25	off	on	off	on	off	on
26	on	off	off	on	off	on
27	off	off	off	on	off	on
30	on	on	on	off	off	on
31	off	on	on	off	off	on
32	on	off	on	off	off	on
33	off	off	on	off	off	on
34	on	on	off	off	off	on
35	off	on	off	off	off	on
36	on	off	off	off	off	on
37	off	off	off	off	off	on

DH+ Station Number	Switch					
	1	2	3	4	5	6
40	on	on	on	on	on	off
41	off	on	on	on	on	off
42	on	off	on	on	on	off
43	off	off	on	on	on	off
44	on	on	off	on	on	off
45	off	on	off	on	on	off
46	on	off	off	on	on	off
47	off	off	off	on	on	off
50	on	on	on	off	on	off
51	off	on	on	off	on	off
52	on	off	on	off	on	off
53	off	off	on	off	on	off
54	on	on	off	off	on	off
55	off	on	off	off	on	off
56	on	off	off	off	on	off
57	off	off	off	off	on	off
60	on	on	on	on	off	off
61	off	on	on	on	off	off
62	on	off	on	on	off	off
63	off	off	on	on	off	off
64	on	on	off	on	off	off
65	off	on	off	on	off	off
66	on	off	off	on	off	off
67	off	off	off	on	off	off
70	on	on	on	off	off	off
71	off	on	on	off	off	off
72	on	off	on	off	off	off
73	off	off	on	off	off	off
74	on	on	off	off	off	off
75	off	on	off	off	off	off
76	on	off	off	off	off	off
77	off	off	off	off	off	off

### Specifying the Serial Interface of Channel 0

Specify RS-232C, RS-422A, or RS-423 communication for Channel 0 by setting the switches of assembly SW2.

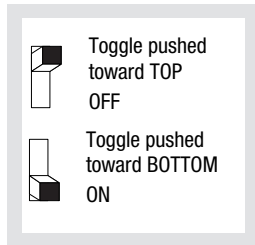
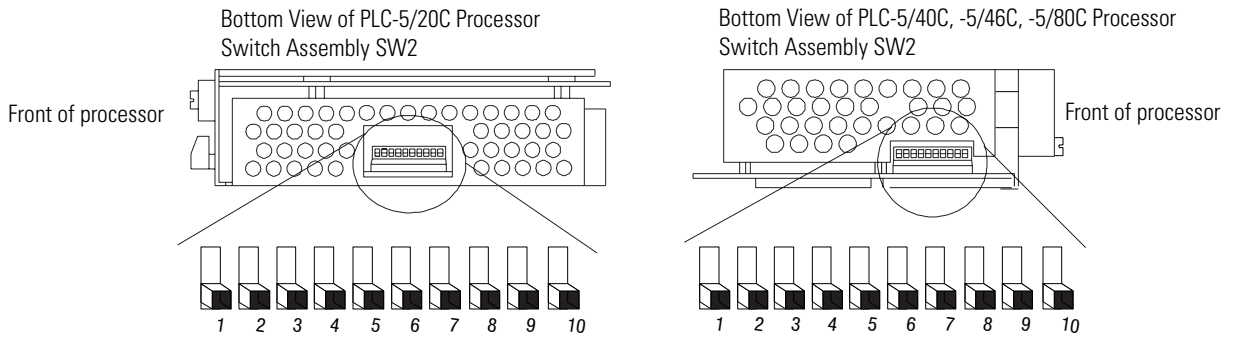

To Specify:	Set Switches:									
	1	2	3	4	5	6	7	8	9	10
RS-232C	ON	ON	ON	OFF	OFF	ON	ON	OFF	ON	OFF
RS-422A	OFF	OFF	ON	OFF	OFF	OFF	OFF	OFF	ON	OFF
RS-423	ON	ON	ON	OFF	OFF	ON	OFF	OFF	ON	OFF

### Selecting the ControlNet Network Address of Channel 2

Select your processor's ControlNet network address by setting the two 10-digit rotary switches on the top of the processor.

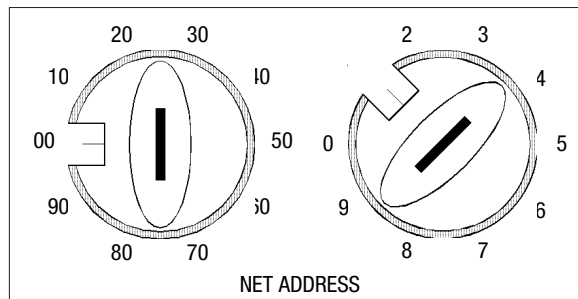

Network address 01 is shown

▶ For optimum throughput, assign addresses to your ControlNet nodes in a sequential order starting with 01.

You can select from as many as 99 network addresses (from 01 to 99) for a processor on a ControlNet link. 0 is invalid.

**Important:** Do **not** power-up the processor if the processor's ControlNet network address is set to **0**. If you do, you will not be able to communicate with your processor and your **ladder program will be lost**, even if you have a battery installed. If this happens, select a valid network address for the processor and cycle power.



## Inserting/Removing the Processor into/from the I/O Chassis

To insert/remove the processor into/from the chassis, do the following:

### WARNING



If you insert or remove the processor while backplane power is on, an electrical arc can occur. This could cause an explosion in hazardous location installations. Be sure that power is removed or the area is nonhazardous before proceeding.

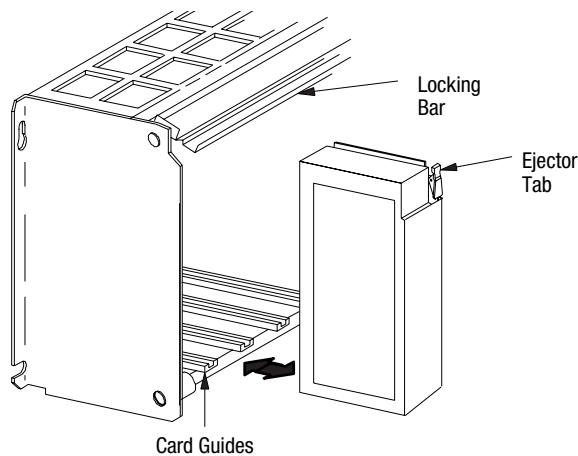

To **insert** a processor into the chassis:

1. Lift the locking bar and the ejector tab.
2. Slide the processor into the left-most slot of the I/O chassis.
3. Press down on the ejector tab, and then close the locking bar over the processor.

To **remove** a processor from the chassis:

1. Save processor memory.
2. Remove power to the processor-resident chassis.
3. Disconnect all cables from the processor's ports.
4. Lift the locking bar and the ejector tab, and then slide the processor from the chassis.

## Installing a Remote I/O Link

Trunk-cable/drop-cable considerations:

When using a trunk-cable/drop-cable configuration, use 1770-SC station connectors and follow these cable-length guidelines:

- trunk-cable length—depends on the communication rate of the link; see Table 1.A
- drop-cable length—30.4 m (100 cable-ft) maximum

**Important:** When using a trunk-cable/drop-cable configuration, set your communication rate to 57.6K bit/s.



For more information about designing trunk-cable/drop-cable configurations, see the Data Highway/Data Highway Plus/Data Highway II/Data Highway 485 Cable Installation Manual, publication 1770-6.2.2.

Install a remote I/O link using 1770-CD cable and either a daisy-chain or trunk-cable/drop-cable configuration.

Verify that your system's design plans specify cable lengths within allowable measurements.

**Important:** The maximum cable length for remote I/O depends on the transmission rate. Configure all devices on a remote I/O link to communicate at the same rate.

**Table 1.A Correct Cable Length Based on Communication Rate**

A remote I/O link using this communication rate:	Cannot exceed this cable length:
57.6K bit/s	3,048 m (approximately 10,000 ft)
115.2K bit/s	1,524 m (approximately 5,000 ft)
230.4K bit/s	762 m (approximately 2,500 ft)

For proper operation, terminate both ends of a remote I/O link by using the external resistors shipped with the programmable controller. Use either a 150Ω or 82Ω terminator.

If your remote I/O link:	The maximum number of		
	Use this resistor rating:	physical devices that you can connect on the link is:	logical rack numbers that you can scan on the link is:
Operates at 230.4K bit/s	82Ω	32	16
Operates at 57.6K or 115.2K bit/s, and <b>no</b> devices listed below are linked			
Scanners 1771-SN; 1772-SD, -SD2; 1775-SR, -S4A, -S4B; 6008-SQH1, -SQH2			
Adapters 1771-AS; 1771-ASB (Series A Only); 1771-DCM			
Miscellaneous 1771-AF			
Connects to any device listed below:	150Ω	16	16
Operates at 57.6K or 115.2K bit/s, and you do not require over 16 physical devices			
Scanners 1771-SN; 1772-SD, -SD2; 1775-SR, -S4A, -S4B; 6008-SQH1, -SQH2			
Adapters 1771-AS; 1771-ASB (Series A Only); 1771-DCM			
Miscellaneous 1771-AF			

You can install a remote I/O link two ways:

- trunk cable/drop cable--from the drop cable to the connector screw terminals on the remote I/O connectors of the processor
- daisy chain--to the connector screw terminals on the remote I/O connectors of the processor and then to the remote I/O screw terminals of the next remote I/O device

To connect remote I/O cable, use the Phoenix MTSB2.5/3-ST 3-pin header connector provided in the accessory kit.

1. Run the 1770-CD cable from the processor to each remote I/O adapter module or processor in the remote I/O system.
2. Connect the signal conductor with blue insulation to the 3-pin connector terminal labeled 1 on the processor and to each remote I/O adapter module (or PLC-5 adapter) in the remote I/O system.
3. Connect the shield drain wire to the center terminal of the 3-pin connector.
4. Connect the signal conductor with clear insulation to the 3-pin connector terminal labeled 2.
5. Tie-wrap the remote I/O network cable to the chassis to relieve strain on the cable.
6. Terminate the remote I/O link by connecting an external terminator resistor between the remote I/O terminals labeled 1 and 2.

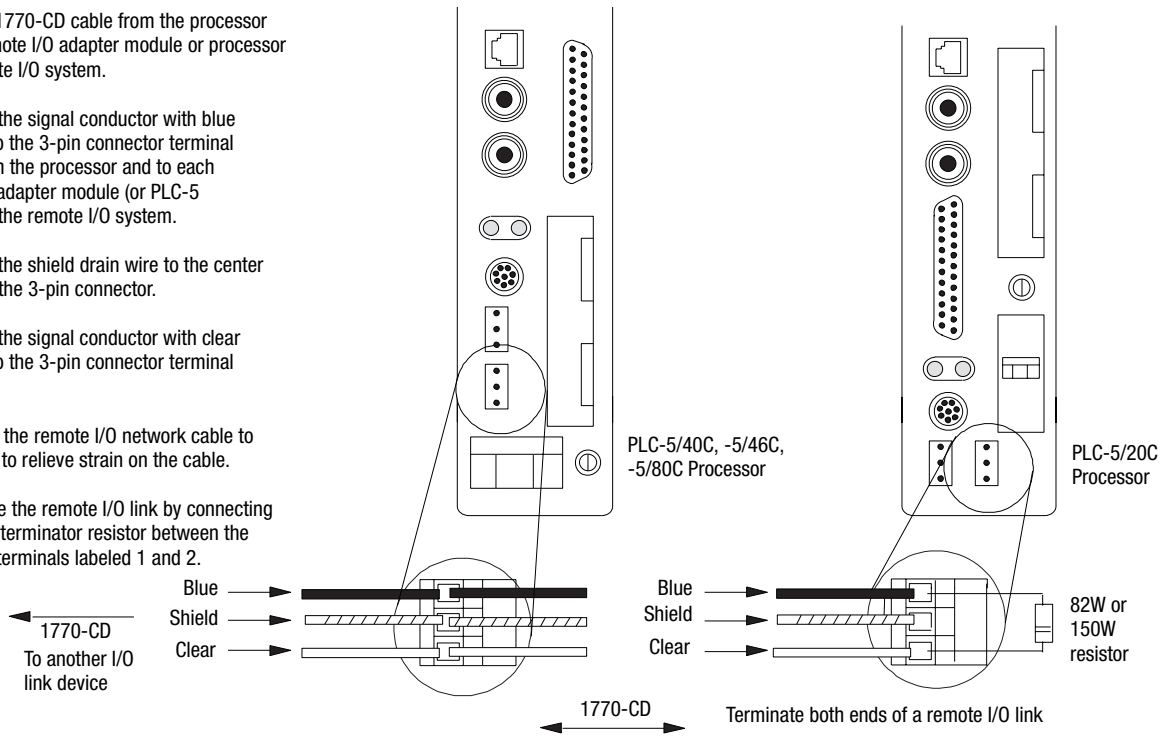

**WARNING**

If you connect or disconnect the 1770-CD cable with power applied to this processor or the device on the other end of the cable, an electrical arc can occur. This could cause an explosion in hazardous location installations. Be sure that power is removed or the area is nonhazardous before proceeding.

**WARNING**

When used in a Class I, Division 2, hazardous location, this equipment must be mounted in a suitable enclosure with proper wiring method that complies with the governing electrical codes.

## Installing a DH+ Link

Use 1770-CD cable to connect the processor to a DH+ link.

Follow these guidelines while installing DH+ communication links:

- do not exceed these cable lengths:
  - trunk-cable length—3,048 m (approximately 10,000 cable-ft)
  - drop-cable length—30.4 m (approximately 100 cable-ft)
- do not connect more than 64 stations on a single DH+ link

Use the 3-pin connector on the processor to connect a DH+ link. The connector's port must be configured to support a DH+ communication link.

You can install a DH+ link two ways:

- trunk cable/drop cable--from the drop cable to the connector screw terminals on the DH+ connectors of the processor.
- daisy chain--to the connector screw terminals on the DH+ connectors of the processor.

To make connections, use the Phoenix connector MTSB2.5/3-ST 3-pin header connector provided in the accessory kit.

1. Connect the signal conductor with clear insulation to the 3-pin connector terminal 1 at each end of each cable segment.
2. Connect the shield drain wire to the center terminal of the 3-pin connector at both ends of each cable segment.
3. Connect the signal conductor with blue insulation to the 3-pin connector terminal 2 at each end of each cable segment.

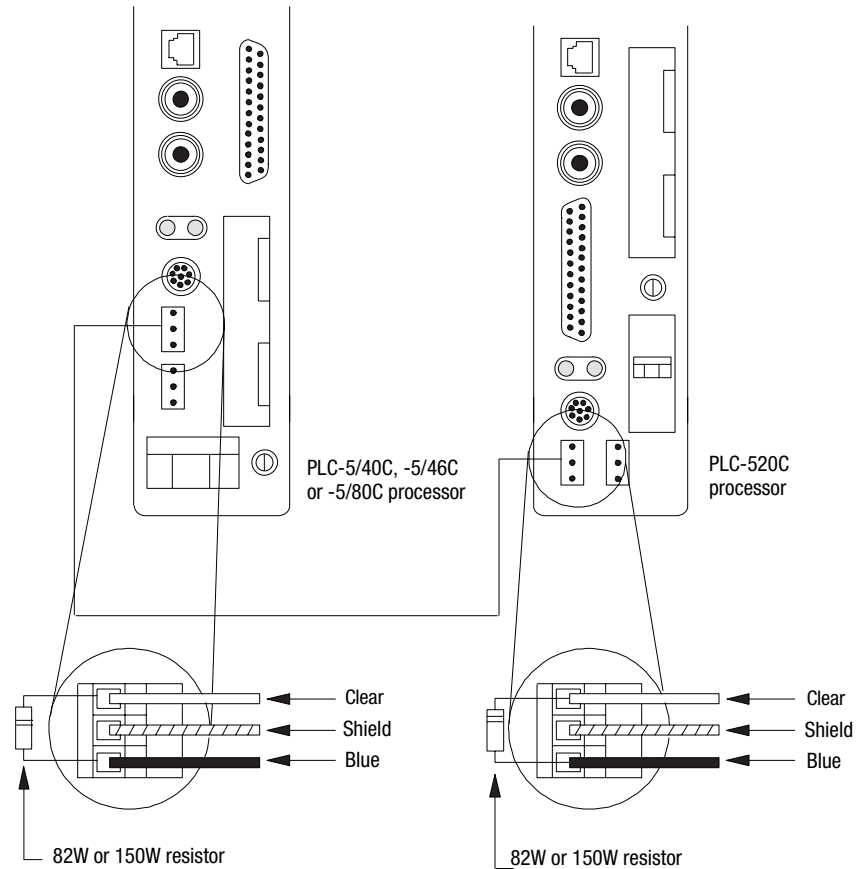

### WARNING



If you connect or disconnect the 1770-CD cable with power applied to this processor or the device on the other end of the cable, an electrical arc can occur. This could cause an explosion in hazardous location installations. Be sure that power is removed or the area is nonhazardous before proceeding.

### WARNING



When used in a Class I, Division 2, hazardous location, this equipment must be mounted in a suitable enclosure with proper wiring method that complies with the governing electrical codes.

## Connecting to a ControlNet Network

Connect a ControlNet PLC-5 processor to a ControlNet network via a tap with a 1-m (39.4-in) drop cable.

**WARNING** If you connect or disconnect the ControlNet tap cable with power applied to this processor or the device on the other end of the cable, an electrical arc can occur. This could cause an explosion in hazardous location installations. Be sure that power is removed or the area is nonhazardous before proceeding.



**WARNING** When used in a Class I, Division 2, hazardous location, this equipment must be mounted in a suitable enclosure with proper wiring method that complies with the governing electrical codes.



Four taps are available from Rockwell Automation:

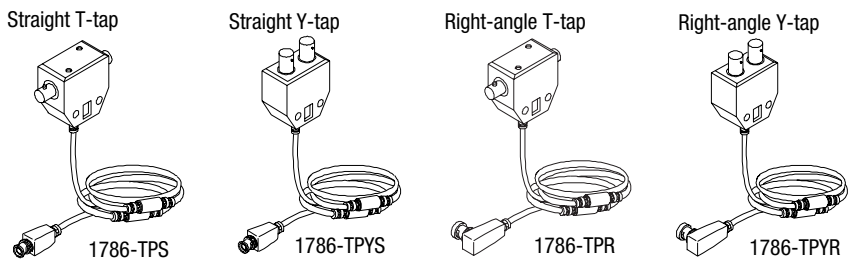

**Important:** ControlNet taps contain passive electronics and must be purchased from Rockwell Automation for the network to function properly.

After terminating your segments, you connect your node to the network.

Remove the tap's dust cap – located on the straight or right-angle connector – and set it aside.

- |  |  |
|--|--|
| <p><b>If your network supports:</b></p> <p>nonredundant media</p> <p>redundant media</p> | <p><b>Connect the tap's straight or right-angle connector:</b></p> <p>to the <b>channel A</b> connector on the processor – channel B is not used<sup>1</sup></p> <ul style="list-style-type: none"> <li>• from <b>trunk-cable A</b> to <b>channel A</b> on the processor</li> <li>and</li> <li>• from <b>trunk-cable B</b> to <b>channel B</b> on the processor</li> </ul> |
|--|--|

<sup>1</sup> Rockwell Automation recommends using channel A for nonredundant media.

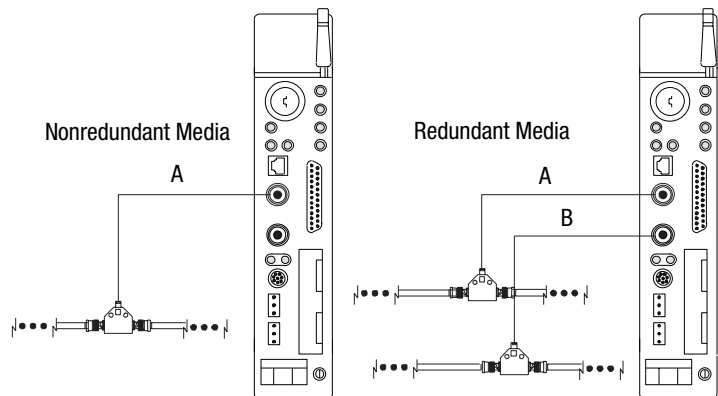

For detailed information about planning and installing your ControlNet system, see the following publications:

<b>Publication</b>	<b>Publication Number</b>
ControlNet Cable System Component List	AG-2.2
ControlNet Cable System Planning and Installation Manual	1786-6.2.1
ControlNet Network Access Cable Installation Instructions	1786-2.6
ControlNet Fiber Planning and Installation Guide	CNET-IN001A-EN-P
System Design for Control of Electrical Noise	GMC-RM001A-EN-P
Industrial Automation Wiring and Grounding Guidelines	1770-4.1
Terminating Your ControlNet Coaxial Cables CD-ROM	CNET-DM001A-EN-C

To view or order these publications online, visit:

<http://literature.rockwellautomation.com>

## Connecting a Programming Terminal

You can connect a programming terminal to a ControlNet PLC-5 processor via a:

- DH+ connection
- serial channel
- ControlNet connection

### WARNING



When used in a Class I, Division 2, hazardous location, this equipment must be mounted in a suitable enclosure with proper wiring method that complies with the governing electrical codes.

### WARNING



If you connect or disconnect the DH+ cable with power applied to this processor or the device on the other end of the cable, an electrical arc can occur. This could cause an explosion in hazardous location installations. Be sure that power is removed or the area is nonhazardous before proceeding.

## DH+ Connection

To attach a personal computer to a ControlNet PLC-5 processor using a DH+ connection:

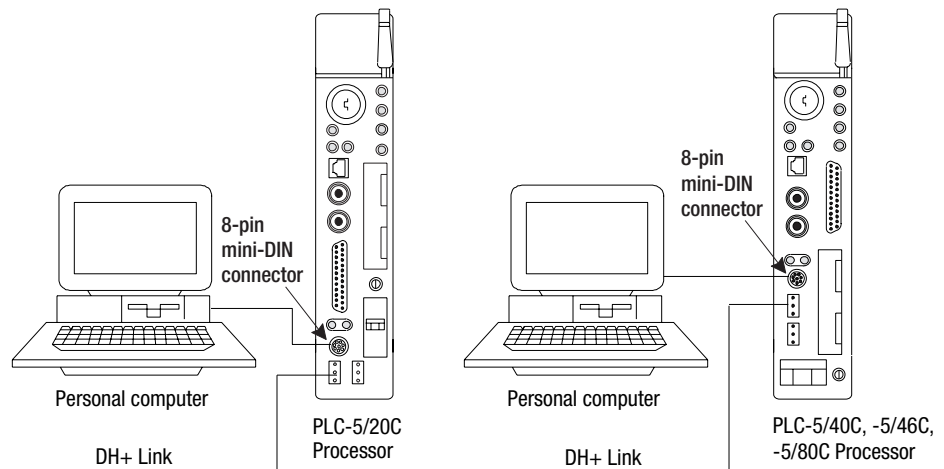

When using this communication card:	Use this cable:
1784-KTX, KTXD	<ul style="list-style-type: none"> <li>• 1784-CP13</li> </ul>
1784-PCMK	<ul style="list-style-type: none"> <li>• 1784-PCM6</li> <li>• 1784-PCM5 with 1784-CP7 adapter</li> </ul>
1784-PKTX, -PKTXD	<ul style="list-style-type: none"> <li>• 1784-CP13</li> </ul>

### Serial Channel

To program the processor using Channel 0, configure the channel for RS-232C using DF1 point-to-point protocol.

If your personal computer has a **9-pin serial port**, use the **1784-CP10 cable**.

If your personal computer has a **25-pin serial port**, use the **1784-CP11 cable**.

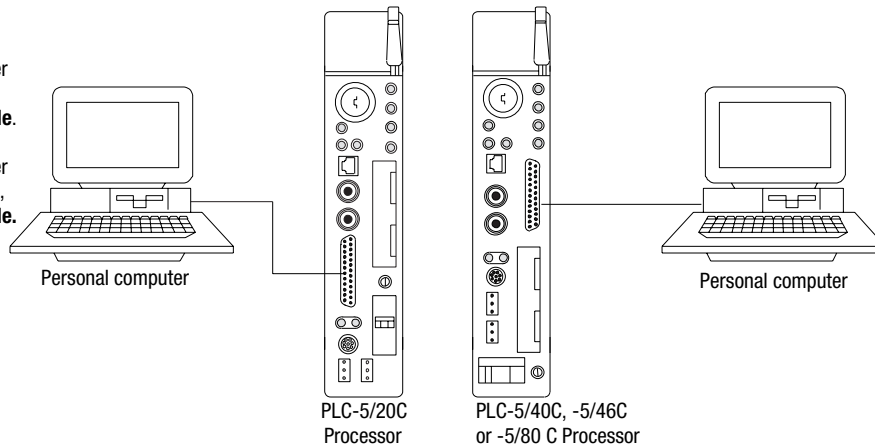

### WARNING



If you connect or disconnect the serial cable with power applied to this processor or the device on the other end of the cable, an electrical arc can occur. This could cause an explosion in hazardous location installations. Be sure that power is removed or the area is nonhazardous before proceeding.





**ATTENTION:** Do not connect the same communication card to both the NAP and a tap on the ControlNet network.

## ControlNet Connection

You can connect programming devices to a ControlNet network through:

- the ControlNet network access cable (1786-CP)
- the ControlNet 1784-PCC1 cable
- a tap on a ControlNet network

### Examples of ControlNet Connection Types

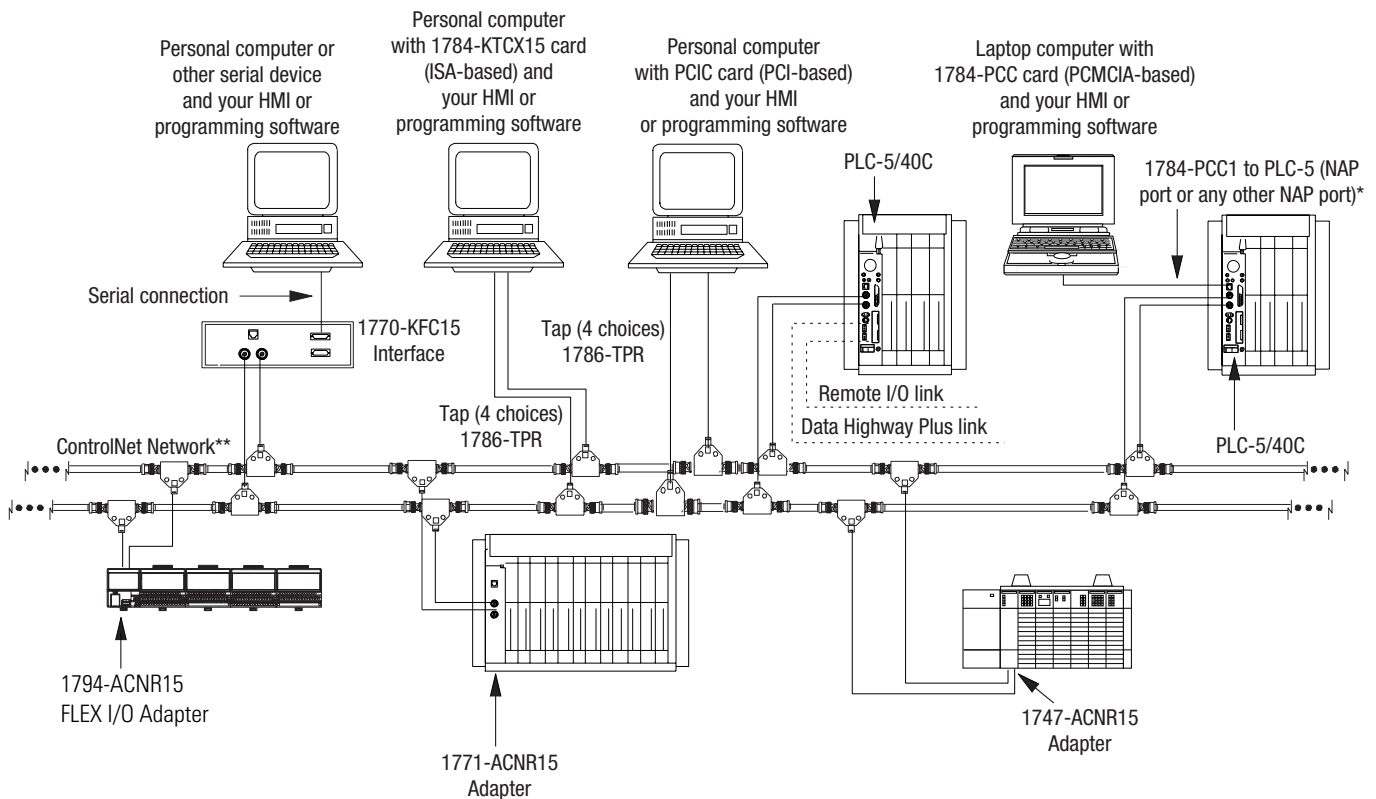

\*A programming terminal connected through this cable is counted as a node and must have a unique address.

\*\*Redundant media not required.

**Important:** Use the 1786-CP cable when connecting a programming terminal to the network through a NAP. Using a commercially available RJ-style cable could result in network failure.

### WARNING



If you connect or disconnect the ControlNet cable with power applied to this processor or the device on the other end of the cable, an electrical arc can occur. This could cause an explosion in hazardous location installations. Be sure that power is removed or the area is nonhazardous before proceeding.

**WARNING**

When used in a Class I, Division 2, hazardous location, this equipment must be mounted in a suitable enclosure with proper wiring method that complies with the governing electrical codes.

## Selecting Appropriate Cables

This section lists information about:

- serial cables
- DH+ programming cables
- remote I/O cables
- ControlNet cables

For more information about cables, see the Enhanced and Ethernet PLC-5 Programmable Controllers User Manual, publication 1785-6.5.12.

## Serial Cables

You can make your own serial cables or purchase them from Rockwell Automation.

The side label of the processor shows the following table, which lists Channel 0 (serial port) pin assignments.

Pin	RS-232C	RS-422A	RS-423
1	C.GND	C.GND	C.GND
2	TXD.OUT	TXD.OUT <sup>+</sup>	TXD.OUT
3	RXD.IN	RXD.IN <sup>+</sup>	RXD.IN
4	RTS.OUT	RTS.OUT <sup>+</sup>	RTS.OUT
5	CTS.IN	CTS.IN <sup>+</sup>	CTS.IN
6	DSR.IN	DSR.IN <sup>+</sup>	DSR.IN
7	SIG.GND	SIG.GND	SIG.GND
8	DCD.IN	DCD.IN <sup>+</sup>	DCD.IN
9			
10	NOT USED	DCD.IN <sup>-</sup>	NOT USED
11			
12			
13	NOT USED	CTS.IN <sup>-</sup>	NOT USED

The shading indicates that the pin is reserved.

Pin	RS-232C	RS-422A	RS-423
14	NOT USED	TXD.OUT <sup>-</sup>	SEND COM
15			
16	NOT USED	RXD.IN <sup>-</sup>	REC COM
17			
18			
19	NOT USED	RTS.OUT <sup>-</sup>	NOT USED
20	DTR.OUT	DTR.OUT <sup>+</sup>	DTR.OUT
21			
22	NOT USED	DSR.IN <sup>-</sup>	NOT USED
23	NOT USED	DTR.OUT <sup>-</sup>	NOT USED
24			
25			

This processor's serial port can support these configurations:

Digital Interface	Maximum Cable Length
RS-232C	15 m (approximately 50 ft)
RS-422A (compatible)	61 m (approximately 200 ft)
RS-423	61 m (approximately 200 ft)

**Important:** Follow these guidelines:

- When Channel 0 is configured for RS-422A compatibility, do not use terminating resistors anywhere on the link.
- When Channel 0 is configured for RS-422A (compatible) and RS-423, do not go beyond 61 m (approximately 200 ft). This distance restriction is independent of the transmission rate.

### DH+ Programming Cables

When using this communication card:	Use this cable:
1784-KTX, KTXD	<ul style="list-style-type: none"> <li>• 1784-CP13</li> </ul>
1784-PCMK	<ul style="list-style-type: none"> <li>• 1784-PCM6</li> <li>• 1784-PCM5 with 1784-CP7 adapter</li> </ul>
1784-PKTX, -PKTXD	<ul style="list-style-type: none"> <li>• 1784-CP13</li> </ul>

### Remote I/O Cables

Use 1770-CD or cable for remote I/O. See Inserting/Removing the Processor into/from the I/O Chassis on page 1-13 for more information.

### ControlNet Cables

Several types of RG-6 **quad-shield** cable may be appropriate for your ControlNet installation—depending on the environmental factors associated with your application and installation site.

The following ControlNet cable system components are available from the Rockwell Automation:

Item <sup>1</sup>	Cat. No.	
ControlNet Coax Tool Kit	1786-CTK	
Coax Tap Kit	Right-angle T-tap	1786-TPR
	Straight T-tap	1786-TPS
	Right-angle Y-tap	1786-TPYR
	Straight Y-tap	1786-TPYS
Repeaters	Repeater adapter	1786-RPA
	Copper	1786-RPCD
	Fiber -short	1786-RPFS
	Fiber - medium	1786-RPFM
	Fiber ring - long	<sup>2</sup> 1786-RPFRL
	Fiber ring - extra long	<sup>2</sup> 1786-RPFRXL
	Dummy load	1786-TCAP
Fiberoptic Repeaters	Low-voltage dc	1786-RPA
RG-6 Quad Shield Cable	Standard-PVC CM-CL2	1786-RG6
ControlNet Network Access Cable—3.05 m (10 ft)		1786-CP
PC Card Cable for 1784-PCC		1784-PCC1
BNC Connectors	Barrel (plug to plug)	1786-BNCP
	BNC/RG-6 plug	1786-BNC
	Bullet (jack to jack)	1786-BNCJ
	Isolated-bulkhead (jack to jack)	1786-BNCJI
	Terminators (BNC-75Ω)	1786-XT

<sup>1</sup> For a complete list of ControlNet cable system components that are available from Rockwell Automation and other sources, see the ControlNet Cable System Component List, publication AG-2.2.

<sup>2</sup> Planned availability - March 2002.

**Important:** Install all wiring for your ControlNet system in accordance with the regulations contained in the National Electric Code (or applicable country codes), state codes, and applicable municipal codes.

For detailed information about ControlNet cabling, see the following publications:

<b>Publication</b>	<b>Publication Number</b>
ControlNet Cable System Component List	AG-2.2
ControlNet Cable System Planning and Installation Manual	1786-6.2.1
ControlNet Network Access Cable Installation Instructions	1786-2.6
ControlNet System Overview	1786-2.9
ControlNet Fiber Planning and Installation Guide	CNET-IN001A-EN-P
System Design for Control of Electrical Noise	GMC-RM001A-EN-P
Industrial Automation Wiring and Grounding Guidelines	1770-4.1
Terminating Your ControlNet Coaxial Cable	CNET-DM001A-EN-C

## Notes

## Planning to Use Your ControlNet PLC-5 Processor

### Using This Chapter

Topic	Page
Understanding ControlNet I/O	2-1
Understanding Scheduled Connection Types	2-11
Understanding ControlNet I/O mapping	2-16
Using I/O Mapping Techniques	2-21
Using the ControlNet PLC-5 processor in a ControlNet I/O system	2-31
Converting from a non-ControlNet remote I/O system to a ControlNet I/O system	2-34
Converting from ControlNet phase 1.0 or 1.25 to ControlNet phase 1.5	2-35

To distinguish phase 1.5 ControlNet processors from earlier phase processors, new catalog numbers were created for each of the phase 1.5 ControlNet processors: 1785-L20C15, 1785-L40C15, L46C15, and 1785-L80C15.

**ATTENTION**

You cannot mix phase 1.5 and earlier phase (such as 1.0 and 1.25) products on the same ControlNet network.

### Understanding ControlNet I/O

The ControlNet system is designed to:

- provide high-speed, repeatable, deterministic I/O transmission
- allow control and message information to co-exist on the same physical media
- make sure that I/O data transfers are not affected by
  - programming-terminal message activity
  - inter-PLC processor message activity on the network

## Scheduled Data-Transfer Operations on a ControlNet Network

ControlNet scheduled data transfer on a ControlNet PLC-5 processor:

- is continuous
- is asynchronous to the ladder-logic program scan
- occurs at the actual rate displayed in the Actual Packet Interval (API) field on the programming software scanlist configuration screen in RSNetWorx for ControlNet software

**Important:** The Requested Packet Interval (RPI) rate requested for a connection establishes the data transfer rate on the ControlNet network. API is determined by RSNetWorx software when the schedule is built. The API will always be the same or less than the RPI.

The API does not imply the actual I/O throughput. I/O data is sent on the network every API regardless of whether the I/O data has been refreshed with newer I/O data. I/O throughput time may be slower due to delays caused by module update times, processor scan times and adapter to I/O module transfer times.

### What Happens During Scheduled Output Data Transfer

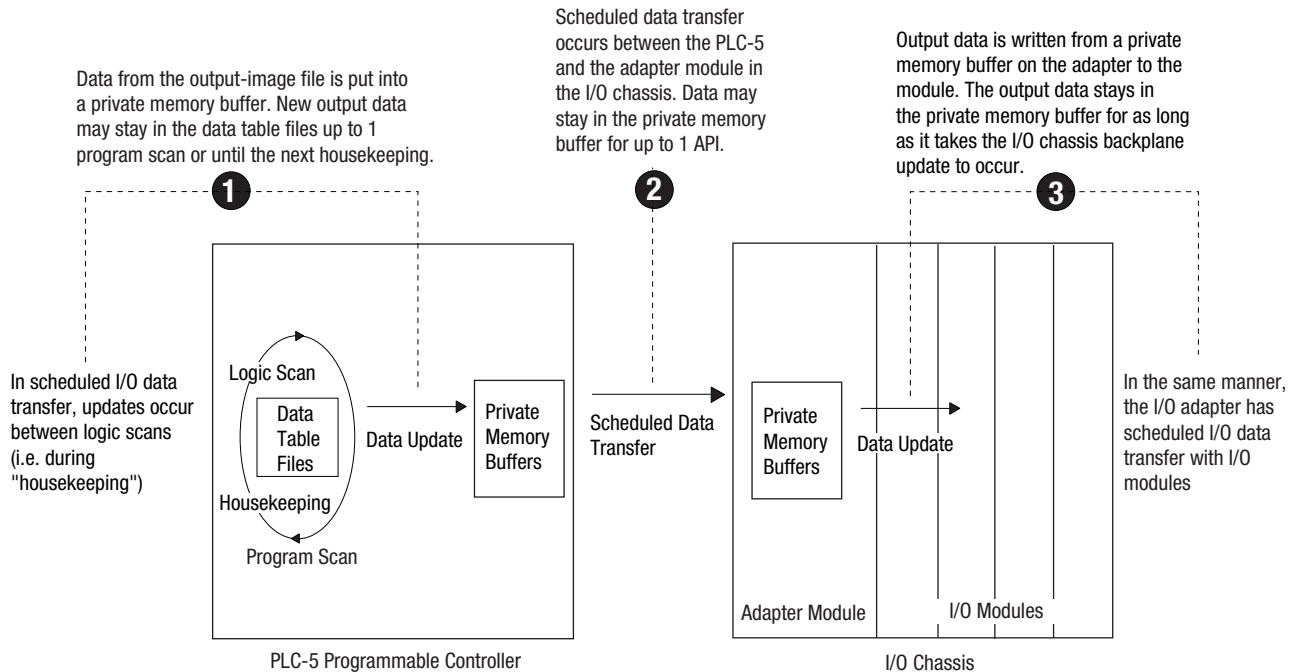



### What Happens During Scheduled Input Data Transfer

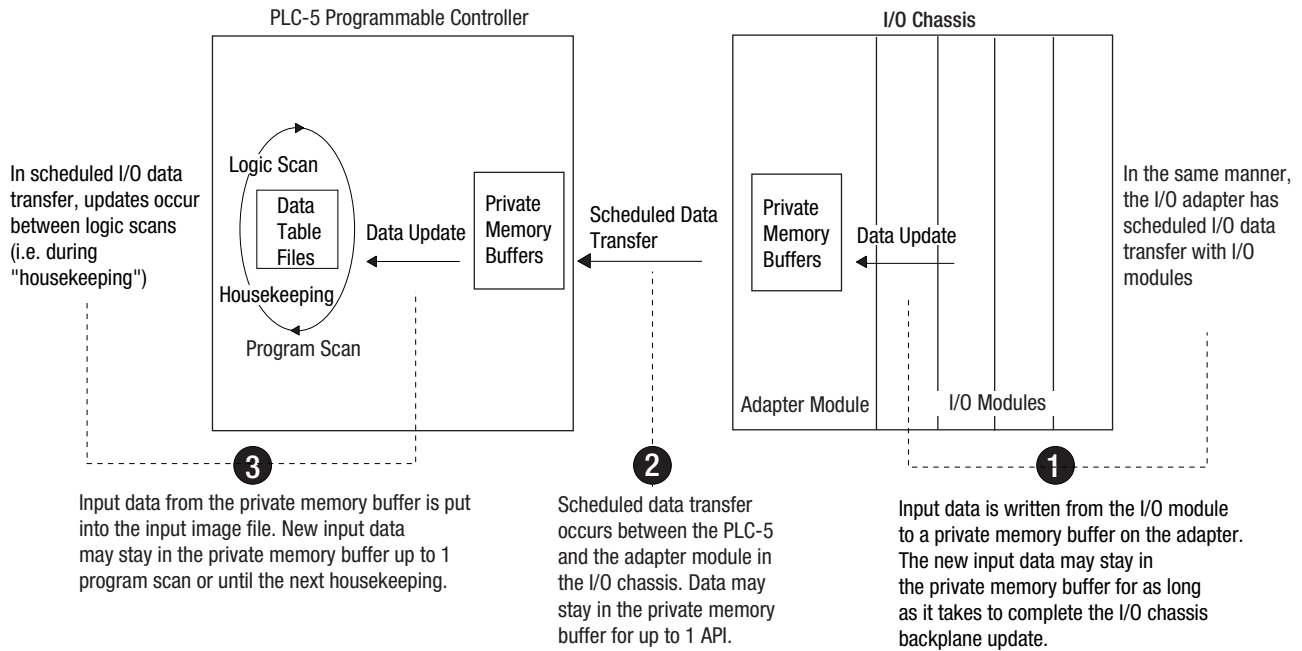

The frequency of I/O chassis backplane updates depends on the adapter, the type of scheduled data transfer (rack or module connection) and the number of different modules being updated. Actual I/O throughput times must be determined with real products to determine if the I/O throughput times meet the requirements of the application.

The following scheduled data-transfer operations are supported by the ControlNet processors on a ControlNet network:

**Table 2.A ControlNet Scheduled Data-Transfer Operations**

Operation	Description
Discrete I/O Data Transfer (can be done as a rack or module connection)	Performed in a deterministic and repeatable manner asynchronous to and independent of the ladder-logic program scan. You configure all ControlNet discrete I/O data transfers on a per-node basis in the I/O map table (scanlist configuration). <sup>1</sup>
Non-discrete I/O Data Transfer (can be done as a module connection)	Handled with the same priority as discrete I/O data transfer. You can update analog data without using block-transfer instructions in ladder programs. You do this by including non-discrete I/O data-transfer configurations in the I/O map table (scanlist configuration). This data is updated in the buffers and data-table files between logic scans in the same manner as that used in discrete I/O data transfer. <sup>1</sup>
Peer-to-peer Communication	Allows a ControlNet processor to communicate with any other ControlNet processor on the ControlNet network with the same priority as that of the discrete and non-discrete I/O data transfers discussed above. <sup>1</sup>

<sup>1</sup> While scheduled data transfer is asynchronous to program scanning, all data is presented synchronously to and from the user data table during housekeeping.

## Unscheduled Data-Transfer Operations on a ControlNet Network

The ControlNet network allows you to use unscheduled messaging when deterministic delivery is not required. Unscheduled operations include:

- unscheduled I/O data transfers, or when unscheduled messaging is event-driven—through ControlNet I/O Transfer (CIO) instructions
- peer-to-peer messaging—through Message (MSG) instructions
- messaging from programming devices
- messaging from Human Machine Interface (HMI) devices

The ControlNet system places your scheduled transfers in the first part of each Network Update Interval (NUI). Time is automatically reserved for network maintenance. Unscheduled transfers are performed during the time remaining in the interval.

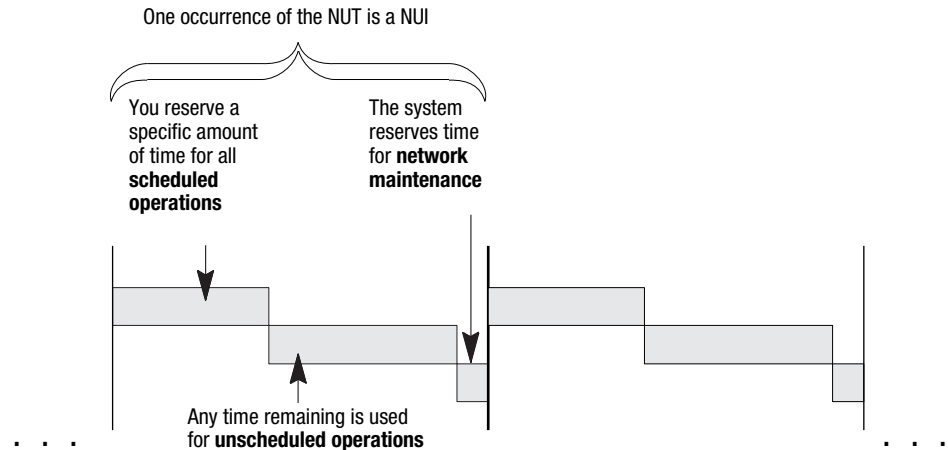

Unscheduled messaging on a ControlNet network is non-deterministic. Your application and your configuration—number of nodes, application program, NUI, amount of scheduled bandwidth used, etc.—determine how much time there is for unscheduled messaging.

**Important:** The ControlNet network reserves time for at least one maximum-sized unscheduled transfer per NUI. Depending on how much time there is for unscheduled messaging, every node may not have a chance to send unscheduled data every NUI.

Table 2.B ControlNet Unscheduled Data-Transfer Operations

Operation	Description	Features
Non-discrete I/O Data Transfer  CIO Instructions	<p>Perform ladder-initiated unscheduled non-discrete I/O data transfers on a ControlNet network by using ControlNet I/O Transfer (CIO) instructions. The data type for these transfers (CT) has the following information:</p> <ul style="list-style-type: none"> <li>• Command:               <ul style="list-style-type: none"> <li>1771 READ reads data from a 1771 non-discrete I/O module</li> <li>1771 WRITE writes data to a 1771 non-discrete I/O module</li> <li>1794 READ reads data from a 1794 I/O module</li> <li>1794 WRITE writes data to a 1794 I/O module</li> <li>1794 FAULT ACTION changes the action a module takes when it faults</li> <li>1794 IDLE ACTION changes the action a module takes when it is idle</li> <li>1794 CONFIG DATA changes a module's configuration data</li> <li>1794 SAFE STATE DATA changes a module's safe-state data</li> <li>CIP GENERIC sends user-specified CIP service</li> <li>Generic bi-directional sends user-specified CIP service which requires reply data</li> <li>1747 READ INPUT reads data from SLC I/O module input file</li> <li>1747 WRITE OUTPUT writes data to SLC I/O module output file</li> <li>1747 READ M0 FILE reads data from SLC I/O module M0 file</li> <li>1747 WRITE M0 FILE writes data to SLC I/O module M0 file</li> <li>1747 READ M1 FILE reads data from SLC I/O module M1 file</li> <li>1747 WRITE M1 FILE writes data to SLC I/O module M1 file</li> <li>1747 SAFE STATE DATA change SLC I/O module safe state data</li> <li>1747 WRITE FLAGS change action SLC I/O module take when it faults and/or goes to idle</li> <li>1747 CONFIG DATA change SLC module's configuration data</li> </ul> </li> <li>• Data-table address in source processor</li> <li>• Size of message in words</li> <li>• Network address of destination node</li> <li>• Slot of destination module</li> <li>• Port number—set to 2 for the ControlNet network</li> <li>• Flags:               <ul style="list-style-type: none"> <li>.TO forces a transfer to time out</li> <li>.EW indicates that the transfer is waiting for an open connection</li> <li>.CO transfer is made continuously in Run mode</li> <li>.ER indicates that the transfer was terminated due to an error</li> <li>.DN indicates that the transfer was made without error</li> <li>.ST indicates that the transfer was started</li> <li>.EN indicates that the transfer instruction is enabled</li> </ul> </li> <li>• Error code—indicates the error when the.ER bit is set<sup>2</sup></li> <li>• Done length—indicates the number of words transferred</li> </ul>	<ul style="list-style-type: none"> <li>• As many as 32 1771 READ and/or 1771 WRITE CIOs can be active at a time<sup>1</sup></li> <li>• Minor fault bit S:17/14 is set when 32 1771 READ and/or 1771 WRITE CIOs are active at a time</li> <li>• As many as a total of 8 1794 FLEX I/O and 1747 SLC I/O CIOs can be active at a time<sup>1</sup></li> <li>• Minor fault bit S:17/15 is set when 8 1794 FLEX I/O CIOs are active at a time</li> <li>• Any transfer initiated from a Processor Input Interrupt (PII) or Selectable Timed Interrupt (STI) program suspends execution of the program scan until the transfer is completed <b>Important:</b> This can extend your program scan by tens of milliseconds.</li> <li>• No transfer is initiated when the processor is in Program mode</li> <li>• Transfers that have been running with the.CO bit set automatically restart on the Program-to-Run transition when the Continue Last step bit is set and the data table has not changed</li> <li>• A transfer has a maximum size of 64 words</li> <li>• If the SFC startover bit is set in the processor configuration file, continuous CIOs may time out if you cycle power in RUN mode. If this happens, the CIO error bit is set. To reset the error bit, the CIO instruction rung condition must go from FALSE to TRUE.</li> </ul> <p>See Chapter 4 and Appendices C and F for more information.</p>

Operation	Description	Features
Peer-to-peer Messaging  MSG Instructions	You can use ControlNet message (MSG) instructions and the data-type MG to create unscheduled messages that are initiated by one ControlNet PLC-5 processor and sent to another ControlNet PLC-5 processor. The MG data type for the ControlNet instruction has the following information: <ul style="list-style-type: none"> <li>• Command—PLC-5 TYPED READ, PLC-5 TYPED WRITE, PLC-3 WORD RANGE READ, PLC-3 WORD RANGE WRITE, PLC-2 UNPROTECTED READ, PLC-2 UNPROTECTED WRITE</li> <li>• Data-table address in source processor</li> <li>• Size of message in elements</li> <li>• Network address of destination processor</li> <li>• Data-table address in destination processor</li> <li>• Port number—set to 2 for the ControlNet network</li> <li>• Flags:                             <ul style="list-style-type: none"> <li>.TO forces a message to time out</li> <li>.EW indicates that the message is waiting for an open connection</li> <li>.CO message is sent continuously in Run mode</li> <li>.ER indicates that the message was terminated due to an error</li> <li>.DN indicates that the message was sent without error</li> <li>.ST indicates that the message was started</li> <li>.EN indicates that the message instruction is enabled</li> <li>.NC forces the connection to close when the message is done</li> </ul> </li> <li>• Error code—indicates the error when the.ER bit is set<sup>2</sup></li> </ul>	<ul style="list-style-type: none"> <li>• As many as 32 ControlNet MSGs can be active at a time<sup>1</sup></li> <li>• Minor fault bit S:17/13 is set when 32 ControlNet MSGs are active at a time</li> <li>• All messages have the same priority</li> <li>• No message is initiated when the processor is in Program mode</li> <li>• Messages that have been running with the.CO bit set automatically restart on the Program-to-Run transition when the Continue Last step bit is set and the data table has not changed</li> <li>• Each message has a maximum size of 1000 elements</li> </ul> See chapter 4 and Appendices C and F for more information.

<sup>1</sup> Because connections are opened and closed as needed, more can exist in a program as long as no more than this number are active at one time.  
<sup>2</sup> See Appendix D for a list of ControlNet error codes.

### Using I/O Forcing Operations

ControlNet I/O forcing occurs in the same way as remote I/O forcing in the ControlNet processors. The processor performs the forcing and transmits the forced data to the output- and input-image tables. You can force any discrete I/O data placed in the I/O image; however, forcing of DIF and DOF data is not supported.

For detailed information about forcing, see your programming software documentation.

### Using Immediate Data-Transfer Operations

ControlNet Immediate Data I/O transfers—Immediate Data Input (IDI) and Immediate Data Output (IDO)—perform similarly to the Remote-I/O supported immediate I/O transfers—Immediate Input (IIN) and Immediate Output (IOT)—which the ControlNet system also supports. The logic scan is temporarily interrupted while the most recent state of up to 64 words is read from or written to the private memory buffer.

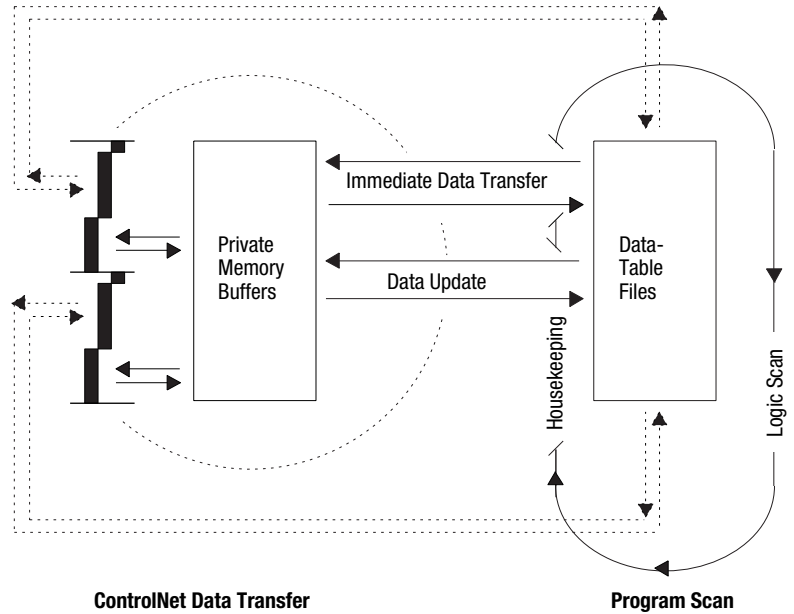

**Table 2.C ControlNet Immediate Data-Transfer Operations**

Instructions	Description												
<p>Immediate I/O-ControlNet and Remote I/O</p> <p>001 —( IIN )—</p> <p>001 —( IOT )—</p>	<p>In the case of an IIN, the most recent copy of the specified input word secured in the last discrete I/O data transfer from the corresponding I/O chassis is used. This value is moved from the private memory buffer to the working data table and is used in all subsequent ladder instructions. This data could be as old as the time taken since the last asynchronous I/O update, and it may not actually reflect the latest state of the input word.</p> <p>In the case of an IOT, the current state of the specified output word is copied to the private memory buffer and is used on the next output update to the I/O chassis. The actual change is not communicated until the next asynchronous I/O transfer.</p> <p>Only 1 word of I/O data can be updated per instruction.</p>												
<p>ControlNet Immediate Data I/O</p> <div style="border: 1px solid black; padding: 5px; margin-bottom: 10px;"> <p style="text-align: center;">IDI</p> <p>IMMEDIATE DATA INPUT</p> <table style="width: 100%; border-collapse: collapse;"> <tr> <td style="border-right: 1px solid black; padding-right: 5px;">Data file offset</td> <td style="padding-left: 5px;">232</td> </tr> <tr> <td style="border-right: 1px solid black; padding-right: 5px;">Length</td> <td style="padding-left: 5px;">10</td> </tr> <tr> <td style="border-right: 1px solid black; padding-right: 5px;">Destination</td> <td style="padding-left: 5px;">N11:232</td> </tr> </table> </div> <div style="border: 1px solid black; padding: 5px;"> <p style="text-align: center;">IDO</p> <p>IMMEDIATE DATA OUTPUT</p> <table style="width: 100%; border-collapse: collapse;"> <tr> <td style="border-right: 1px solid black; padding-right: 5px;">Data file offset</td> <td style="padding-left: 5px;">175</td> </tr> <tr> <td style="border-right: 1px solid black; padding-right: 5px;">Length</td> <td style="padding-left: 5px;">24</td> </tr> <tr> <td style="border-right: 1px solid black; padding-right: 5px;">Source</td> <td style="padding-left: 5px;">N12:175</td> </tr> </table> </div>	Data file offset	232	Length	10	Destination	N11:232	Data file offset	175	Length	24	Source	N12:175	<p>The ControlNet Immediate Data I/O instructions work in much the same way as the immediate I/O instructions. During an input instruction, the most recent data is copied from the private memory buffer to a data-table address that you specify. In the case of an output instruction, the data is copied from an area that you specify to the private memory buffer and sent on the next I/O update. As many as 64 words can be transferred per instruction.</p> <p><b>Important:</b> In most cases, you should set the Data file offset and the Source of an IDO or the Data file offset and the Destination of an IDI to the same address. See Chapter 4 for more information on this and other aspects of using ControlNet IDI and IDO instructions.</p>
Data file offset	232												
Length	10												
Destination	N11:232												
Data file offset	175												
Length	24												
Source	N12:175												

**Using Process Control Sample Complete**

Scheduled data transfers occur continuously and asynchronously to the program scan. If a scheduled connection is an input, then incoming data is copied to a private input buffer upon its receipt. If a scheduled connection is an output, then data from a private output buffer is transmitted during each scheduled communication. Your data table files and private buffers are synchronized during housekeeping, which occurs between program scans. During housekeeping, the latest inputs are copied from the private memory buffers to the processor’s input data table files (file 1 and the DIF) and the output data table files (file 0 and the DOF) are copied to the private output buffers.

In some instances, however, it is useful to have access to new input data as soon as it has been received without waiting for housekeeping to take place at the end of the program scan. Process control sample complete enables you to do so for the following scheduled connection types:

- 1747 analog or module connection
- 1771 analog or module connection
- 1794 analog or module connection
- receive scheduled message

You enable process control sample complete on a per connection basis by setting the PCSC enable bit in the connection’s ControlNet I/O status file entry.

When process control sample complete is enabled for a connection and the processor is in RUN mode, newly received data for that connection is immediately copied into your data table (even if the processor is in the middle of a program scan) and the PCSC new data bit is set in the connection’s ControlNet I/O status file entry. This data will not be updated again during a program scan until you clear the PCSC new data bit. The data is updated during housekeeping, regardless of the state of the new data bit.

If new data is received and the PCSC new data bit is already set, then the PCSC overflow bit is set. In this event, your data table will not be updated. Process control sample complete uses bits 2, 3, and 4 of the first word of the ControlNet I/O status file entry. See Appendix D for more information about the ControlNet I/O status file.

The input data must be mapped into the DIF. PCSC is not enabled if the input data is mapped into the discrete input image table.

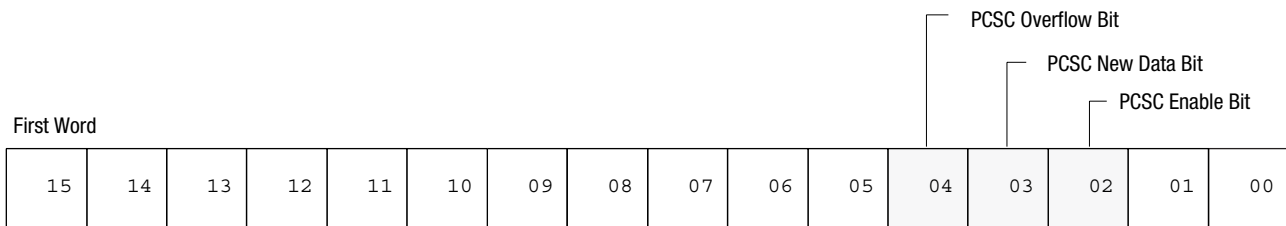

Bit	Description
2—PCSC Enable	When this bit is set, the processor updates your ControlNet data input file when new data is received. Process control sample complete can be dynamically enabled and disabled by your program during a program scan. This can be done by setting and clearing the PCSC enable bit of the connection’s entry in the ControlNet status file. After this bit has been set, the input data should not be read until the PCSC new data bit has been set by the processor.
3—PCSC New Data	This bit is set by the processor when the PCSC enable bit is set to one and new data has been copied to the ControlNet data input file. To insure that you do not access this data while the processor is copying new data to the data input file, <b>do not</b> access the data until the PCSC new data bit has been set by the system. When this bit is set to one, it signifies that new data has been received and it is safe to read from your ControlNet data input file. This data is not updated again until you clear this bit or until housekeeping occurs between program scans. <b>Never</b> set this bit to one.
4—PCSC Overflow	This bit indicates that your program is not checking the PCSC new data bit often enough to use all processor control sample complete data that has arrived. If the PCSC new data bit has not been cleared by the time a new data sample arrives, the PCSC overflow bit is set and the new data is <b>not</b> copied to the ControlNet data input file. You must clear this bit. If you clear the PCSC New Data bit but not the PCSC overflow bit, the ControlNet data input file is still updated when the next process control sample complete data is received. <b>Never</b> set this bit to one.



### Clearing the PCSC New Data and PCSC Overflow Bits

If it is crucial to maintain the integrity of the PCSC overflow bit after new data has arrived while clearing the PCSC new data and overflow bits. Then do the following:

1. Disable process control sample complete by setting the PCSC enable bit for the connection to zero.

When process control sample complete is disabled, the system will not modify the new data and overflow bits while you clear them.

2. Clear the PCSC new data and the PCSC overflow bits.
3. Re-enable process control sample complete by setting the connection's PCSC enable bit back to one.

### Considerations When Using PCSC

When using scheduled ControlNet 1.5 communications to analog I/O (such as map entries) and you are using the PID instruction in the PLC-5/15, then you should do the following:

- the analog module must be set up to use RTS (Real Time Sample) mode
- set your analog RPI (Repetitive Packet Interval) to be at least twice the RTS time
- your ladder program needs to set the PCSC enable bit
- your ladder program needs to use the PCSC done bit to condition the execution of the PID instruction
- the PID loop update must equal the RTS rate
- your ladder program must use the PCSC overflow bit to take appropriate action on an overflow condition

## Understanding Scheduled Connection Types

Scheduled connections are made to I/O devices such as I/O adapters and to peer-to-peer devices such as other controllers.

There are some common scheduled connection types made from the ControlNet PLC-5 to other Allen-Bradley products that are detailed in the following section. These scheduled connection types have certain behaviors and limitations that you must understand before configuring the connections. The ControlNet PLC-5 can also make scheduled connections to products not manufactured by Allen-Bradley. Refer to the literature that accompanies those products for information on their scheduled connection behavior.

Scheduled connection types made from the ControlNet PLC-5 to I/O adapters can be made either to some or all of the discrete I/O on the adapter (called a rack connection), or to individual modules (called a module connection).

There are four general types of scheduled connections from the ControlNet PLC-5 to I/O adapters:

- **exclusive owner** - these scheduled connections indicate the PLC-5 has exclusive ownership of the outputs. These scheduled connections can also gather inputs from the device. There cannot be more than one exclusive owner connection made to either the rack connection or module connection at a time.
- **input only** - these scheduled connections only gather inputs from the I/O adapters. These scheduled connections do not require other scheduled connection types to be first established before its scheduled connection can be established.
- **listen only** - these scheduled connections are similar to input only scheduled connections, except that they require a different scheduled connection to be first established before its connection can be established.
- **redundant owner** - these scheduled connections are similar to exclusive owner scheduled connections because they both can control outputs and gather inputs. The difference between them is that with redundant owner scheduled connections, multiple ControlNet PLC-5 controllers can establish identical redundant connections. Only one of the controllers that establish the redundant scheduled connection will own the outputs.

Redundant connections can only be used in a PLC-5 ControlNet Hot Backup system. Refer to the PLC-5 ControlNet Hot Backup User Manual, publication 1785-6.5.24 for more information on using redundant connections.

### **Allowable Scheduled Connection Type Combinations for I/O Adapter Connections**

Only specific combinations of scheduled connection types are allowable. RSNetWorx software will have a pull down list showing all allowable schedule connection types.

The following details about these combinations assume that different processors are making either rack connections to the same adapter or module connections to the same slot.

**Important:** The 1771-ACN(R15) requires a rack connection to be established before any module connections are accepted.

If an **exclusive owner** connection is made to the adapter:

- another exclusive owner connection will be rejected
- an input only connection can be made
- a listen only connection can be made
- a redundant owner connection will be rejected

If an **input only** connection is made to the adapter:

- an exclusive owner connection can be made
- another input only connection can be made
- a listen only connection can be made
- a redundant owner connection can be made

A **listen only** connection can only be made to the adapter if:

- an exclusive owner connection already exists, or
- an input only connection already exists, or
- a redundant owner connection already exists

If a **redundant owner** connection is made to the adapter:

- an exclusive owner connection will be rejected
- an input only connection can be made
- a listen only connection can be made
- another identical redundant owner connection can be made

### Multiple Processors Can Control I/O on the Same ControlNet Link

A processor at any valid node address can control the outputs of a particular module or rack. However, only one processor can control the same outputs at any one time.

In the following figure, the processor at node 1 can control the outputs of node 2 while the processor at node 3 controls the outputs of node 4.

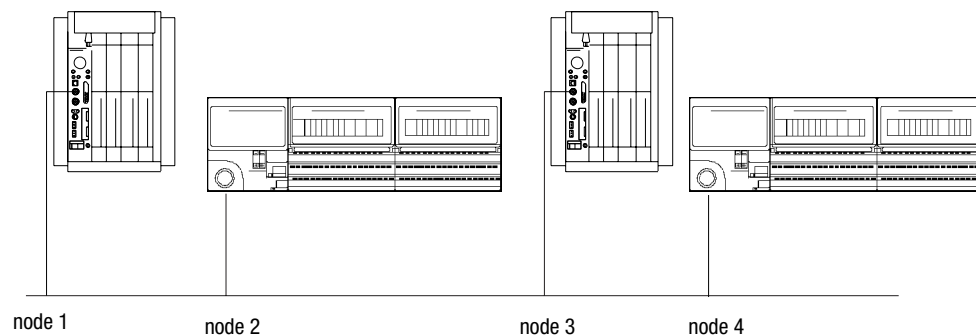

## Understanding Multicast Inputs

This feature enables input devices to send the same data to multiple processors simultaneously.

Advantages of multicast inputs include:

- Network optimization - reduces network usage since data is sent only once simultaneously to all connections. This reduction may allow more complex scheduled connection configurations or improved unscheduled connection performance.
- Device synchronization - inputting data to all devices simultaneously improves synchronization between devices

In the following example, the ControlNet PLC-5 processor at node 2 is sending outputs to the adapter at node 3. Nodes 1, 2, and 4 are all receiving the same input packet from node 3. Nodes 1 and 4 are considered listen-only and are producing heartbeats to keep their connections to the adapter alive.

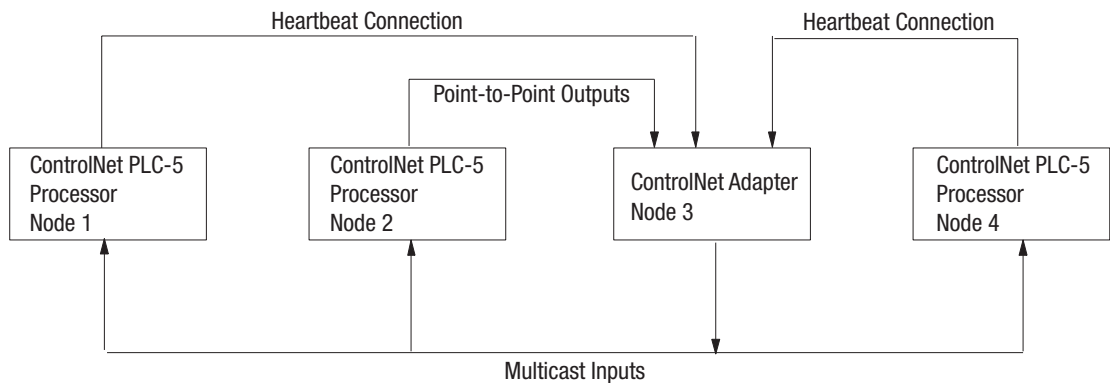

## Understanding Multicast Outputs

This feature enables the PLC-5 to simultaneously send the same output data to more than one target device. To use this feature, both the PLC-5 and the target devices must support multicast outputs.

Advantages of multicast outputs include:

- Network optimization - reduces network usage since data is sent only once simultaneously to all connections. This reduction may allow more complex scheduled connection configurations or improved unscheduled connection performance.
- Device synchronization - outputting data to all devices simultaneously improves synchronization between devices

### Using Multicast Outputs

To use multicast outputs, you must first configure each Multicast Output connection in RSNetwork 3.0:

1. In the Details Tab of Connection Properties dialog, change the Scanner to Target Network Connection to **Multicast**. You cannot modify this field for any device that does not support multicast outputs.
2. The Scanner to Target Multicast ID of the Details Tab indicates to which multicast output group the connection belongs. All connections with the same Multicast ID will have their output data combined into a single transmission on the ControlNet network.

The processor will combine the output data into a single packet and simultaneously send it to all assigned connections that have the same:

- Request Packet Interval
- Output Address in the PLC-5 data table
- Output Size

You must determine if the output data being sent to each device of a multicast group is compatible with the application.

Using Multicast Outputs affects the ControlNet I/O Status file Immediate Inhibit bit and ControlNet I/O Status file Reset bit functionality:

- **ControlNet I/O Status file Immediate Bit** - since all connections in a Scanner to Target Multicast ID group share the same output data, the Immediate Inhibit Bit will not take effect until all connections of that group have their immediate inhibit bit set. After the immediate inhibit takes place, you may independently re-enable each connection by clearing this bit.
- **ControlNet I/O Status file Reset Bit** - all connections of a Scanner to Target Multicast ID group must have this bit set or cleared so that the target devices are put into the correct state. The Reset Bit affects all connections for a given multicast ID group.

## Understanding ControlNet I/O Mapping

All scheduled data transfers must be mapped on a ControlNet network. You specify where I/O data is to be read from or written to—i.e., mapped. You do this and establish the relationship between processors, I/O adapters, and data-table file addresses by creating and maintaining an I/O map table. An I/O map-table entry is required for each scheduled data transfer. The map table is stored in the configuration section of memory and is not accessible by your application program.

Using your programming software, you can automatically configure and map nodes attached to your ControlNet I/O. See Using I/O Mapping Techniques in Chapter 2 for information about ControlNet automatic configuration and I/O mapping.

### Reserving Space for Non-ControlNet I/O

Non-ControlNet processor-resident local I/O and Remote-I/O devices can only use fixed I/O image locations based on rack number for discrete I/O data transfer, while discrete I/O data transfer between ControlNet nodes can be mapped to any unused location in the I/O image tables. Before mapping your ControlNet I/O, therefore, you should configure any processor-resident local I/O and any Remote I/O racks on non-ControlNet channels. This allows the programming software to reserve input- and output-image space for all non-ControlNet processor-resident local I/O and Remote-I/O chassis.

### Processor-Resident Local I/O

If you first configure processor-resident local I/O on your processor, the programming software reserves processor-resident local chassis input- and output-image space starting at offset 0 in both files.

The following table shows the default number of input and output words automatically reserved by the programming software for the different sizes and addressing modes of processor-resident local I/O:

Addressing Mode	Number of Words Reserved			
	4 Slots	8 Slots	12 Slots	16 Slots
2 Slot	8	8	8	8
1 Slot	8	8	16	16
1/2 Slot	8	16	24	32

**Important:** ControlNet I/O cannot map into any part of a rack number used by the processor-resident rack.

## Remote I/O

The following table shows the default number of input and output words reserved by the programming software for the different sizes and addressing modes of non-ControlNet Remote I/O if you first configure non-ControlNet Remote I/O on your processor:

Addressing Mode	Number of Words Reserved			
	4 Slots	8 Slots	12 Slots	16 Slots
2 Slot	2	4	6	8
1 Slot	4	8	12	16
1/2 Slot	8	16	24	32

The programming software reserves non-ControlNet Remote-I/O output- and input-image space according to these guidelines:

- It does not overlap processor-resident local I/O reserved image space
- It addresses input- and output-image space offset in octal from
  - 00-37—for the PLC-5/20C15 processor
  - 00-177—for the PLC-5/40C15 processor
  - 00-177—for the PLC-5/46C15 processor
  - 00-277—for the PLC-5/80C15 processor
- The output-image offset value in the I/O map corresponds to the first slot of the referenced chassis—i.e., in a 4-slot chassis set for 1-slot addressing, the corresponding output-image offset of O:10 would map the words O:10, O:11, O:12, and O:13 to slots 0, 1, 2, and 3 respectively
- The input-image offset corresponds to the first slot in the referenced rack, and the offset location of the input modules in that rack corresponds to the same offset in the image table—i.e., if a chassis set for 1-slot addressing has an input-image offset of I:10 and an input module in slot 3, the word that corresponds to that input module would be I:10 + 3, or I:13

## Supported ControlNet I/O Sizes

The following table shows the maximum I/O map entries allowed in the ControlNet I/O map table:

**Table 2.D Maximum I/O Map Entries**

Processor:	Number of Mappings:	Number of DIF Files:	Number of DIF Words:	Number of DOF Files:	Number of DOF Words:
PLC-5/20C15	64	2	2000	2	2000
PLC-5/40C15	96	3	3000	3	3000
PLC-5/46C15	96	3	3000	3	3000
PLC-5/80C15	128	4	4000	4	4000

Each map-table entry corresponds to one transfer—input only, output only, or both input and output—of data between the ControlNet processor and an I/O rack, an I/O module, or another ControlNet processor.

**Table 2.E Files That You Configure with the I/O Map for Scheduled I/O Usage**

File	Description
ControlNet Status File	User-specified integer data table file containing status information about this processor's scheduled I/O map-table entries. Each I/O map table entry has a status-file offset field pointing to three status words associated with that entry. Refer to Appendix D for more information on I/O map-table entry status words.
ControlNet Diagnostics File	User-specified integer data table file containing diagnostics about the ControlNet network (not required). See Appendix F.
Data Input File (DIF)	User-specified integer data-table file with a maximum of: <ul style="list-style-type: none"> <li>• 2000 words for the PLC-5/20C processor (spanning two contiguous data table files)</li> <li>• 3000 words for the PLC-5/40C processor (spanning three contiguous data table files)</li> <li>• 3000 words for the PLC-5/46C processor (spanning three contiguous data table files)</li> <li>• 4000 words for the PLC-5/80C processor (spanning four contiguous data table files)</li> </ul> This file is typically used for non-discrete input data and peer-to-peer input. Discrete input data may be mapped to DIF as well.
Data Output File (DOF)	User-specified integer data-table file with a maximum of: <ul style="list-style-type: none"> <li>• 2000 words for the PLC-5/20C processor (spanning two contiguous data table files)</li> <li>• 3000 words for the PLC-5/40C processor (spanning three contiguous data table files)</li> <li>• 3000 words for the PLC-5/46C processor (spanning three contiguous data table files)</li> <li>• 4000 words for the PLC-5/80C processor (spanning four contiguous data table files)</li> </ul> This file is typically used for non-discrete output data and peer-to-peer output. Discrete output data may be mapped to DOF as well.
Configuration File	User-specified integer data-table file used to store non-discrete I/O data transfer configuration data. This configuration data is sent to the target device each time the connection is opened.



### Discrete I/O Data-Transfer Mapping

Regardless of the type of I/O—e.g., 1747, 1771, 1794—all ControlNet discrete I/O data is stored within the processor according to the corresponding I/O map-table entry. Discrete I/O data can be stored in either the I/O image table or the DIF/DOF. Any status information transferred along with the I/O data is stored in a separate status file that you specify during configuration.

**Important:** If you want to force your discrete I/O, you must map it to the I/O image table.

### Non-discrete I/O Data-Transfer Mapping

ControlNet non-discrete I/O data can be stored in either the I/O image table or the DIF/DOF. The ControlNet processor supports two distinct image files; both are integer data-table files that you specify:

- Data Input File (DIF)
- Data Output File (DOF)

Each map-table entry for a non-discrete I/O data transfer defines an offset into the DIF or DOF where the data is stored. Using separate data-table files for non-discrete I/O data transfer allows the processor to scan non-discrete I/O data asynchronously to the program scan. Like discrete I/O, the data is presented synchronously to the processor and output buffers during housekeeping.

The DIF and DOF can be overlapped (as in Figure 2.1) so that inputs from one device can be used as outputs to another device. As a result of the overlap, no ladder logic is required to copy the data. If either the DIF or DOF size is greater than 1000 words, then it will span multiple physical files. The physical files comprising the DIF or DOF must be contiguous.

**Figure 2.1 Data Input and Data Output Files**

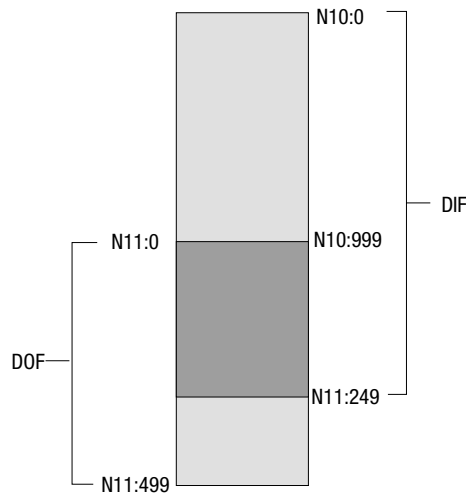

### 1771 Modules

ControlNet 1771 discrete I/O data-transfer mapping requires one map-table entry per node. ControlNet 1771 non-discrete I/O data-transfer mapping requires one map-table entry per module.

The ControlNet scheduled I/O data-transfer mechanism makes it possible to eliminate block-transfer programming to communicate with the 1771 modules. For a complete list of these modules, refer to RSNetWorx for ControlNet documentation.

The types of modules that may be accommodated by the processor's scheduled non-discrete I/O data-transfer mechanism are typically those modules that require a one-time configuration and then continuously read or write.

To communicate with 1771 modules, you can also include explicit CIO instructions in your ladder-logic program. See Chapter 4 and Appendix C for more information.

The 1771 discrete rack must be owned by a processor before any non-discrete connections (scheduled or unscheduled) can be established with the 1771 adapter. The non-discrete connections can be established by the owner processor and/or non-owner processors.

---

**ATTENTION**

The Run/Program mode for all modules in a 1771 chassis is controlled by the owning discrete rack connection. You must consider this when configuring non-discrete connections from other processors.

---

### 1747 Modules

ControlNet 1747 discrete I/O data-transfer mapping requires one map-table entry per node. ControlNet 1747 non-discrete I/O data-transfer mapping requires one map-table entry per module.

The ControlNet scheduled I/O data-transfer mechanism makes it possible to map 1747 modules. For a complete list of these modules, refer to RSNetWorx for ControlNet documentation.

### 1794 Modules

ControlNet 1794 FLEX discrete I/O data-transfer mapping requires one map-table entry per node. ControlNet 1794 non-discrete I/O data-transfer mapping requires one map-table entry per module.

The ControlNet scheduled I/O data-transfer mechanism makes it possible to map 1794 modules. For a complete list of these modules, refer to RSNetWorx for ControlNet documentation.

## Other ControlNet Processors

ControlNet scheduled peer-to-peer communications between ControlNet processors require one map-table entry per message.

You can set up ControlNet peer-to-peer communications between any two processors on a ControlNet network. The ControlNet transfer mechanism makes it possible to map the scheduled peer-to-peer messages listed in the following table.

**Table 2.F Peer-to-Peer Communications Mapping**

Message Type	Description <sup>1</sup>	Valid Sizes
Receive Data From	Scheduled Message	1-240 words
Send Data	Scheduled Message	

<sup>1</sup> RPI Default = 4 x NUT

To communicate between any ControlNet PLC-5 processors on the ControlNet network, you can include MSG instructions in your ladder-logic program. See Chapter 4 and Appendix C for more information.

## Using I/O Mapping Techniques

Discrete I/O interfaced to a PLC-5 processor is typically mapped to the I/O image table. You can map discrete I/O to the DIF and DOF, but you lose the ability to force the I/O if the DIF or DOF is used.

Each version of the PLC-5 processor has a specific amount of I/O image table available, and therefore, a limit on the amount of I/O that can be mapped to the I/O image table. Traditionally, each slot in an I/O chassis is assigned a location in the input image table and the output image table. While this provides very easy mapping of I/O to the image table, it is not the most efficient way to use it. For example, if a slot contains an input module, the corresponding location in the output image table goes unused. With the introduction of the ControlNet network to the PLC-5 processor family, new techniques are available to map discrete I/O into the I/O image table in a more efficient manner.

Input and output data can be mapped to offsets within the I/O image tables and need not be the same size.

## Understanding Discrete Mapping

Each version of a PLC-5 processor has a fixed amount of I/O image space. For example:

This processor:	Has:
PLC-5/20C	32 words of input image table and 32 words of output image table
PLC-5/40C	128 words of input image table and 128 words of output image table
PLC-5/46C	128 words of input image table and 128 words of output image table
PLC-5/80C	192 words of input image table and 192 words of output image table

The I/O image table is used for all discrete I/O connected to the PLC-5 processor, regardless of where it is located (local I/O, Remote I/O, ControlNet network). Since the local chassis reserves a minimum of eight words of input and output, a PLC-5/20C processor has a maximum of 24 words of inputs and 24 words of outputs available for the ControlNet network. Some applications may find that the use of I/O image space needs to be optimized to insure that the I/O requirements can be met.

A node address on a ControlNet network does not directly map to a location in the I/O image table like it does on a Remote I/O network. For example, If you have an 8-slot chassis in 1-slot addressing and set the node address to two, and:

If the node is on a:	Then:
Remote I/O network	the inputs in that chassis automatically map to I:020-I:027 if the node is on a remote I/O network
ControlNet network	you can map the inputs to any location available in the input image table, and the outputs to any location available in the output image table. The input and output locations can be in two totally different rack numbers.

For example, you can specify I:024 as the input location and O:032 as the output location. The only restriction is that you must map the input and output words contiguously. If you mapped eight words of inputs you must map it to a location with eight words available. In this example, words I:024-I:033 must be available.

The ControlNet network also allows the size of the chassis to be set based on what is needed. Using the previous example, the chassis on the Remote I/O network uses eight words of inputs and eight words of outputs, regardless of what modules are actually in the chassis. On the ControlNet network, you can set the sizes to what is actually needed. For example, you can set the input size to six and the output size to three. If no outputs are in the chassis you can set the output size to zero.

### Optimizing the I/O Image Table

You may find that you are close to the I/O image table limits in a PLC-5 processor and need to optimize the use of the I/O image table in order to insure that the application will fit in the processor. This section discusses techniques that make optimal use of the I/O image table available in a PLC-5 processor. The use of these techniques is not required, they merely demonstrate methods which can be used to make maximum use of the available I/O image table. Proceed with caution when using these techniques.

**Important:** You need to understand the ramifications of how you map the I/O before proceeding, as the method you use may make future expansion extremely difficult.

There are two methods to optimize the use of I/O image table in a ControlNet PLC-5 processor.

- optimizing without slot complementary
- optimizing with slot complementary — where you set the I/O chassis backplane switches to a lower density than the modules you are actually using, and then staggering the modules: input, output, input, output, etc. For example, you can set the backplane switches to 2-slot addressing and then place 16-point I/O modules in the rack: input, output, input, output, etc. See *Configuring Complementary I/O for PLC-5 Processors*, publication number 1785-6.8.3, for information about slot complementary I/O.

Both methods make use of arranging the I/O modules in the most efficient manner within the chassis.

In many cases, the optimal solution for a system is a combination of both the methods.

### Optimizing the I/O Image Table without Slot Complementary

The techniques used for I/O image optimization are best illustrated using examples. The following examples all assume 1-slot addressing for all chassis and that the local rack is using rack 0 image table (I:000-007 and O:000-007).

#### Example 1

Examine the following chassis:

ACN	I	O	O	I	O	O	X	X
-----	---	---	---	---	---	---	---	---

I = Discrete Input Module
O = Discrete Output Module
ACN = ControlNet adapter
X = Empty Slot

If you perform an automap on this system, the map table appears like this:

Input file	Input size	Output file	Output size
I:010	8	O:010	8

The automap feature reserves the maximum size of inputs and outputs. It is up to you to manually change the sizes if desired. If you optimize the chassis as shown, the sizes adjust to the following:

Input file	Input size	Output file	Output size
I:010	4	O:010	6

There are two input modules and four output modules in the chassis. However, you cannot set the sizes to two and four because the address you specify is the starting address of the chassis. It identifies the address of the leftmost slot. The size you specify determines how many slots in the chassis written to or read from. (In 1-slot addressing, words equals slots. The concept is the same for any addressing mode. Words are read/written from left to write. In 1/2-slot addressing there are two words per slot.)

In this example, the first slot in the chassis is I:010/O:010, the second slot, I:011/O:011, and so on. The fifth slot is O:014 only. You cannot place an input module in this slot since no input word is mapped to it. The seventh slot has no I/O image table mapped to it. You cannot place a discrete input or output module in the last two slots since there is no I/O image table allocated to it.

**Example 2**

Take another look at the chassis. By moving the modules you can optimize this chassis further. Move all the input modules to the left of the chassis:

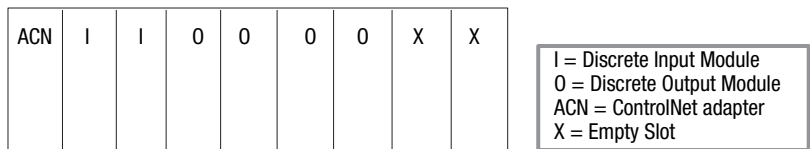

Now if you optimize, the map table looks like this:

Input file	Input size	Output file	Output size
I:010	2	O:010	6

By placing the input modules first, you only have to map two input words to the chassis and do not lose any by having to pass over output modules. The outputs only lose two words by passing over the inputs. This example shows the first rule of module optimization.

**First Rule of Module Optimization**

*When placing discrete modules, put the type (input or output) you have the least of to the left in the chassis.*

**Example 3**

Some chassis may contain analog modules, communication cards, or power supplies. Examine the following chassis:

ACN	A	I	O	I	O	PS	I	I
-----	---	---	---	---	---	----	---	---

I = Discrete Input Module O = Discrete Output Module ACN = ControlNet adapter A = Analog Module PS = Power Supply
---

This chassis contains an analog module and a power supply. Assume all analog modules on a ControlNet network are mapped to an integer table in the PLC-5 processor. Power supplies do not require any I/O image table. Therefore, the optimal configuration of this chassis is:

ACN	O	O	I	I	I	I	A	PS
-----	---	---	---	---	---	---	---	----

I = Discrete Input Module O = Discrete Output Module ACN = ControlNet adapter A = Analog Module PS = Power Supply
---

Input file	Input size	Output file	Output size
I:010	6	O:010	2

Since analog modules and power supplies do not need any I/O image space you should place them to the right so that you don't have to waste any inputs or outputs passing over these modules. This leads to the second important module placement rule of optimization.

**Second Rule of Module Optimization**

*Place modules that do not require I/O image table space to the right in the chassis.*

**Example 4**

To understand how optimization with a ControlNet network preserves I/O image space, look at the following example system:

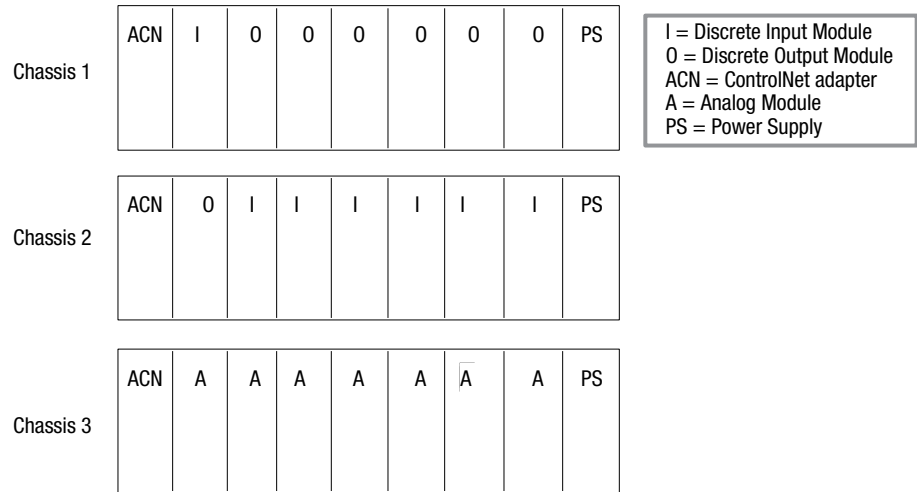

The following chart shows how a Remote I/O system compares to one optimized with a ControlNet network.

Remote I/O					ControlNet Network			
Input			Output		Input		Output	
Chassis	Address	Size	Address	Size	Address	Size	Address	Size
1	I:010	8	O:010	8	I:010	1	O:010	7
2	I:020	8	O:010	8	I:011	7	O:017	1
3	I:030	8	O:030	8	n/a	0	n/a	0
<b>Total Used</b>	24 (3 racks)		24 (3 racks)		8 (1 rack)		8	
<b>Remaining</b>	0		0		16 (2 racks)		16	

If you install the system on a PLC-5/20C processor, the Remote I/O network option would be out of I/O image space, while the ControlNet network option would have used only one-third of the available I/O image space. You must take into account future expansion when optimizing the I/O.



Example 4

Examine the following system:

Chassis 1	ACN	I	O	O	I	I	O	O	O
Chassis 2	ACN	I	A	O	A	X	X	A	I
Chassis 3	ACN	O	O	O	I	I	I	I	A

I = Discrete Input Module O = Discrete Output Module ACN = ControlNet adapter A = Analog Module PS = Power Supply X = Empty Slot
---

	Input file	Input size	Output file	Output size
Chassis 1	I:010	5	O:010	8
Chassis 2	I:015	8	O:020	3
Chassis 3	I:025	7	O:023	3

Assume you want to add an additional output module in one of the empty slots in the second chassis. Only three words of output are mapped to the second chassis. You have to change the output size in the second chassis to five to get to the first empty slot. However, this example started mapping the third chassis at O:023. If you try to set the second chassis size to five, you get an overlap error because words O:023 and O:024 are being used in the third chassis. You can always change the starting address of the third chassis, but then you must change any references to the outputs in your program. It may be better to start mapping the third chassis at O:027 to allow for output expansion. You can add input modules in the empty slots without changing anything since there are already eight words of inputs mapped to the chassis.

**Optimizing the I/O Image Table with Slot Complementary**

Slot complementary makes use of the ability of a chassis to share inputs or outputs between adjacent slots. This allows you to set the density of the chassis to a lower value than the modules used in the chassis and then share the I/O between the slots. For example, you can set a chassis to 2-slot addressing and then place 16-point modules in the chassis, alternating input and output modules.

Example 1

Examine the following chassis:

2-slot addressing  
16-point modules

ACN	I	O	I	O	I	O	I	O
-----	---	---	---	---	---	---	---	---

I = Discrete Input Module  
O = Discrete Output Module  
ACN = ControlNet adapter

In this example the first input module uses eight inputs from the first slot and eight inputs from the second slot (not used by the output module in the second slot). The first output module uses eight outputs from the first slot and eight outputs from the second slot, and so on. Given an 8-slot chassis in 2-slot addressing, there are four words of inputs and four words of outputs used in this chassis. On a ControlNet network, you can map four words of inputs and four words of outputs to this chassis and **no I/O image space is wasted**. If you set the addressing mode to 1-slot addressing and use the methods described in the previous section you waste either four words of input or four words of output image table.

This method works extremely well for cases where there are equal numbers of input and output cards. However, in most cases there are not the same number of each module.

Example 2

Examine the following chassis:

2-slot addressing  
16-point modules

ACN	I	O	I	O	X	O	X	O
-----	---	---	---	---	---	---	---	---

I = Discrete Input Module  
O = Discrete Output Module  
ACN = ControlNet adapter  
X = Empty Slot

In this case you can map two words of input and four words of output to the chassis and not waste any I/O image table. However, you waste physical space (note the two empty slots).

Look at the case where you have 14 input modules and two output modules. If you use slot complementary, you have to purchase an additional chassis, and therefore an additional adapter and power supply, since you can only put eight of the input modules in one chassis (one module every other slot). If you do not use slot complementary, you can fit all the cards in one chassis and only sacrifice two output image table words.

With the slot-complementary method you cannot just put any module anywhere. If you wish to add an output module to the chassis shown above you cannot since there are no **output** slots available; you have to start a new chassis.

### Summary

There are two methods to optimize the use of I/O image table in a ControlNet PLC-5 processor. There are tradeoffs in using each method which are summarized in the following table.

Method:	Tradeoffs:
optimize <b>without</b> slot complementary	<ul style="list-style-type: none"> <li>allows optimization of I/O image table, but not to the extent if using slot complementary</li> <li>does not waste chassis slots</li> <li>can put any module anywhere (provided I/O table exists for that slot)</li> </ul>
optimize <b>with</b> slot complementary	<ul style="list-style-type: none"> <li>allows complete optimization of the I/O image table</li> <li>can waste chassis slots and require additional chassis</li> <li>can only put modules in odd or even slots, depending on the module type</li> </ul>

The best solution in most cases is to combine the two methods. Examine the module requirements at any given chassis or location and see which method fits best. You may find in some areas you have an equal number of input and output modules, and slot complementary optimizing works well. However, you may find in other areas there are space limitations which require the use of the smallest possible chassis, and therefore, you cannot waste slots using slot complementary.

A final point to be aware of is that each system is unique and you must apply these techniques accordingly. For example, you may have the following chassis:

2-slot addressing  
16-point modules

ACN	I	I	O	I	I	I	O	I
-----	---	---	---	---	---	---	---	---

I = Discrete Input Module  
O = Discrete Output Module  
ACN = ControlNet adapter

Using strict rules of optimization you might immediately arrange the chassis like this:

2-slot addressing  
16-point modules

ACN	O	O	I	I	I	I	I	I
-----	---	---	---	---	---	---	---	---

I = Discrete Input Module  
O = Discrete Output Module  
ACN = ControlNet adapter

However, the overall system may be heavy on inputs, and there are no concerns about the output image table. In this case you may want to conserve the input image table for this chassis and arrange it as follows:

2-slot addressing  
16-point modules

ACN	I	I	I	I	I	I	0	0
-----	---	---	---	---	---	---	---	---

I = Discrete Input Module 0 = Discrete Output Module ACN = ControlNet adapter
---

When deciding when, where, and what type of optimization to use, you have to balance:

- space limitations
- additional costs (extra chassis, adapters, etc.)
- I/O image table availability
- future expansion

## Using the ControlNet PLC-5 Processor in a ControlNet I/O System

There can be multiple ControlNet PLC-5 processors updating I/O adapters on a ControlNet network.

- any processor can own adapters on the network
- any processor is allowed to send CIO instructions to I/O modules
- additional processors can do scheduled transfers to any other processor on the ControlNet network by using peer-to-peer communications through the scan configuration list

The following table describes various ControlNet devices that you can add to your network. For a complete listing, contact your local Rockwell Automation sales office.

Catalog Number(s)	Device(s)	Function
1785-L20C15, -L40C15, -L46C15, -L80C15	ControlNet Programmable Controllers	Communicate with other ControlNet nodes using scheduled or unscheduled peer-to-peer communication.
1784-KTC15, -KTCX15, -KTCS	ControlNet ISA Communication Cards	Allows other computer platforms to communicate with the ControlNet network.
1784-PCC	ControlNet PCMCIA Communication Card	Allows other computer platforms to communicate with the ControlNet network.
1770-KFC15, -KFCD15	ControlNet Serial/Parallel Communication Interface	Connects a serial or parallel device to a ControlNet network.
1747-ACN15, -ACNR15	1747 ControlNet SLC I/O Adapters	Allows the ControlNet processor remote access to Allen-Bradley's family of SLC-designated I/O modules via a ControlNet network.
1771-ACN15, -ACNR15	1771 ControlNet I/O Adapters	Allows the ControlNet processor remote access to Allen-Bradley's family of 1771-designated I/O modules via a ControlNet network.
1784-PCIC, -PCICS	ControlNet PCI Communication Cards	Allows other computer platforms to communicate with the ControlNet network.
1794-ACN15, -ACNR15	1794 ControlNet FLEX I/O Adapters	Allows the ControlNet processor remote access to Allen-Bradley's family of 1794-designated I/O modules via a ControlNet network.
1797-ACN15	1797 ControlNet Ex I/O Adapter	Allows the ControlNet processor remote access to Allen-Bradley's family of 1797-designated I/O modules via a ControlNet network.
1788-CN2DN, -CN2FF	1788 ControlNet Linking Devices	Allows the ControlNet processor to link to DeviceNet or Foundation Fieldbus networks.
1756-CNBR, 1756-CN2	ControlLogix ControlNet Bridge	Allows the ControlNet processor remote access to Allen-Bradley's family of 1756 controllers via a ControlNet network.
PV 550, 600, 900, 1000, 1400, 1000e and 1400e	Panel View ControlNet products with ControlNet comm option	Allows the ControlNet processor remote access to Allen-Bradley's PanelView ControlNet operator interfaces via a ControlNet network.
1203-CN1	Any scan port drive or device that communicates thru 1203-CN1	Allows the ControlNet processor remote access to Allen-Bradley's scan port drives or devices that communicate through a 1203-CN1 via a ControlNet network.
1336T AC Vector Drive, 1395 Digital DC Drive	Drives with direct fiber ControlNet connections	Allows the ControlNet processor remote access to Allen-Bradley's AC Vector and Digital DC drives via a ControlNet network.

**Example of a ControlNet Network without Redundant Media**

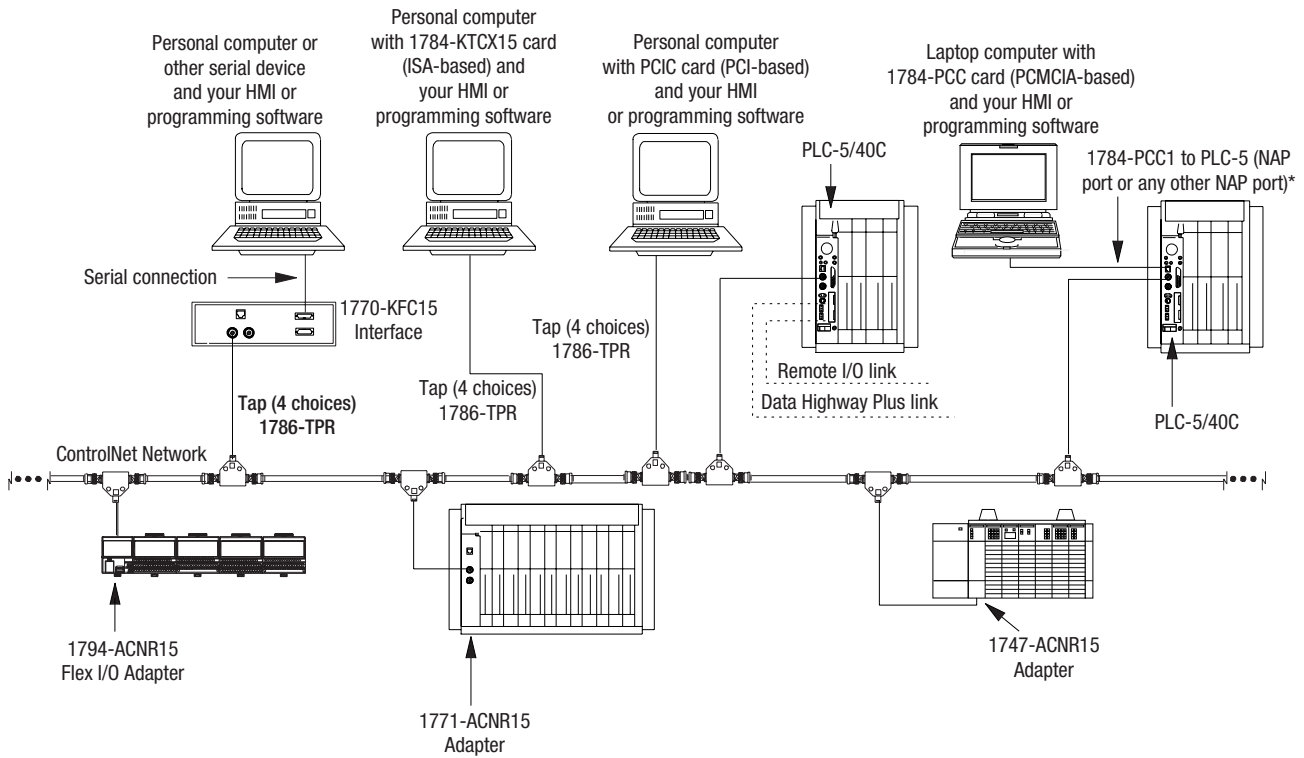

**Example of a ControlNet Network with Redundant Media**

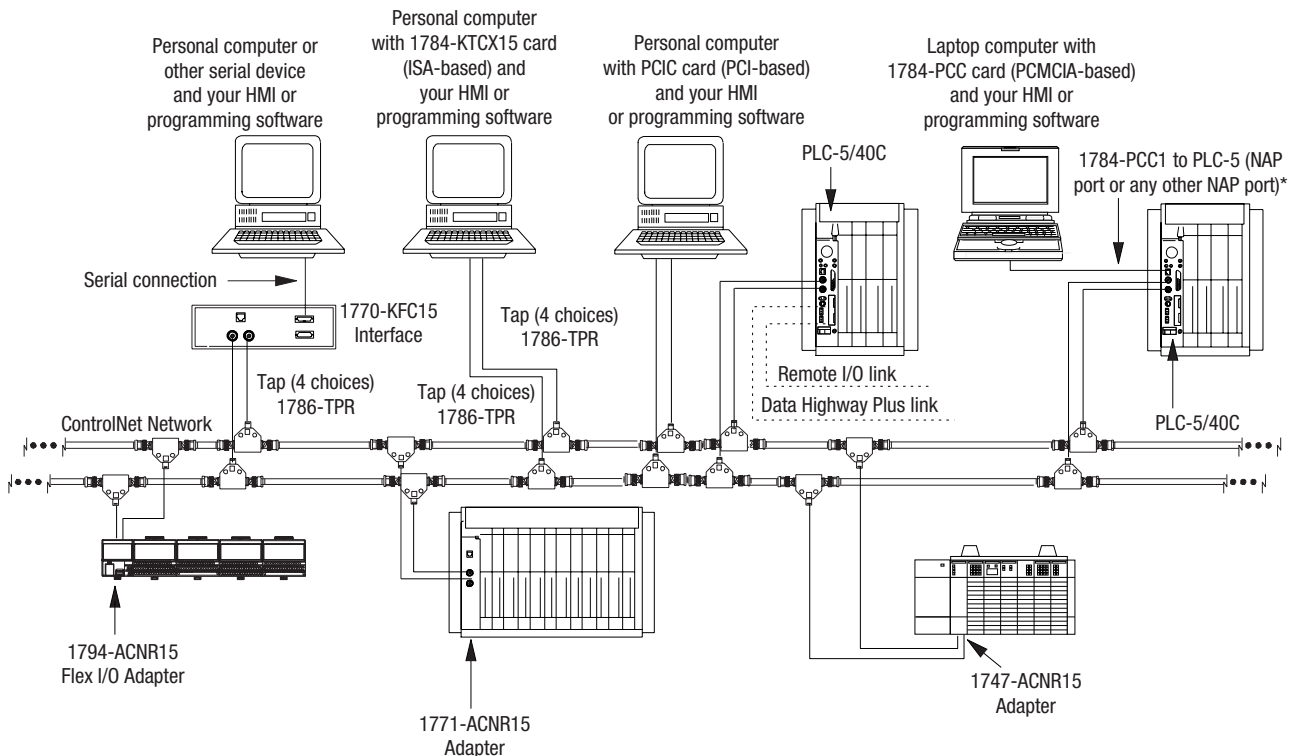

**WARNING**

When used in a Class I, Division 2, hazardous location, this equipment must be mounted in a suitable enclosure with proper wiring method that complies with the governing electrical codes.

**Distributed Keeper Functionality**

All ControlNet processors now keep the ControlNet configuration. The processor with the lowest node address acts as the master keeper, while the other processors serve as backups. If the master keeper drops off the network, the next-lowest numbered processor takes over as the master keeper. No user intervention is required.

**Important:** ControlNet PLC-5 programmable controllers with firmware revision E/B, D/C, or C/L are single keeper devices. All later releases are distributed keeper devices.

There are two rules you must follow when combining single keeper devices and distributed keeper devices on the same network:

- if there is a single keeper device at node 1, there can be no distributed keeper devices on the network
- if there are distributed keeper devices on the network, single keeper devices can also be allowed on the network. However, there cannot be a single keeper device at node 1.

If you plan to have distributed keeper devices on the network, we recommend that you flash upgrade the single keeper devices to be distributed keeper devices.

## Converting from a Non-ControlNet Remote I/O System to a ControlNet I/O System

When you download archived files to a ControlNet PLC-5 processor, the programming software ignores Channel 2 configuration information from anything other than a ControlNet-processor program because Channel 2 is reserved for ControlNet communication on the ControlNet processors. The software sets Channel 2 to the default ControlNet configuration.

Program files <sup>1</sup> for this process:	Archived from a:	On channel:	Can be run on a ControlNet PLC-5 channel:	If they fit and are:	
Messaging and I/O	<ul style="list-style-type: none"> <li>• PLC-5/11</li> <li>• PLC-5/20</li> <li>• PLC-5/20C15</li> <li>• PLC-5/20E</li> <li>• PLC-5/30</li> <li>• PLC-5/40</li> <li>• PLC-5/40C15</li> <li>• PLC-5/46C15</li> <li>• PLC-5/40E</li> </ul>	<ul style="list-style-type: none"> <li>• PLC-5/40L</li> <li>• PLC-5/60</li> <li>• PLC-5/60L</li> <li>• PLC-5/80</li> <li>• PLC-5/80C15</li> <li>• PLC-5/80E</li> </ul>	0	0	downloaded unchanged
			1A	1A	
	<ul style="list-style-type: none"> <li>• PLC-5/20</li> <li>• PLC-5/20C15</li> <li>• PLC-5/20E</li> <li>• PLC-5/30</li> <li>• PLC-5/40</li> <li>• PLC-5/40C15</li> <li>• PLC-5/46C15</li> <li>• PLC-5/40E</li> </ul>	<ul style="list-style-type: none"> <li>• PLC-5/40L</li> <li>• PLC-5/60</li> <li>• PLC-5/60L</li> <li>• PLC-5/80</li> <li>• PLC-5/80C15</li> <li>• PLC-5/80E</li> </ul>	1B	1B	
	<ul style="list-style-type: none"> <li>• PLC-5/20C15</li> <li>• PLC-5/40C15</li> </ul>	<ul style="list-style-type: none"> <li>• PLC-5/46C15</li> <li>• PLC-5/80C15</li> </ul>	2	2	



Program files <sup>1</sup> for this process:	Archived from a:	On channel:	Can be run on a ControlNet PLC-5 channel:	If they fit and are:	
Messaging and I/O continued	<ul style="list-style-type: none"> <li>• PLC-5/11</li> <li>• PLC-5/20</li> <li>• PLC-5/20C15</li> <li>• PLC-5/20E</li> <li>• PLC-5/30</li> <li>• PLC-5/40</li> <li>• PLC-5/40C15</li> <li>• PLC-5/40E</li> </ul>	<ul style="list-style-type: none"> <li>• PLC-5/40L</li> <li>• PLC-5/46C15</li> <li>• PLC-5/60</li> <li>• PLC-5/60L</li> <li>• PLC-5/80</li> <li>• PLC-5/80C15</li> <li>• PLC-5/80E</li> </ul>	1A	2	performed by the ControlNet network—you must make these changes manually by reprogramming <sup>2,3,4</sup>
	<ul style="list-style-type: none"> <li>• PLC-5/20</li> <li>• PLC-5/20C15</li> <li>• PLC-5/20E</li> <li>• PLC-5/30</li> <li>• PLC-5/40</li> <li>• PLC-5/40C15</li> <li>• PLC-5/40E</li> </ul>	<ul style="list-style-type: none"> <li>• PLC-5/40L</li> <li>• PLC-5/46C15</li> <li>• PLC-5/60</li> <li>• PLC-5/60L</li> <li>• PLC-5/80</li> <li>• PLC-5/80C15</li> <li>• PLC-5/80E</li> </ul>	1B	2	
	<ul style="list-style-type: none"> <li>• PLC-5/40</li> <li>• PLC-5/60</li> </ul>	<ul style="list-style-type: none"> <li>• PLC-5/80</li> </ul>	2A or 2B	2	
				1A or 1B	performed by DH+ or remote I/O—you must make these changes manually by reprogramming <sup>5</sup>
	<ul style="list-style-type: none"> <li>• PLC-5/20E</li> <li>• PLC-5/40E</li> <li>• PLC5/40L</li> </ul>	<ul style="list-style-type: none"> <li>• PLC-5/60L</li> <li>• PLC-5/80E</li> </ul>	2	1A or 1B	performed by DH+ or remote I/O—you must make these changes manually by reprogramming <sup>5</sup>
			2	performed by the ControlNet network—you must make these changes manually by reprogramming <sup>3,4,5</sup>	

<sup>1</sup> These include processor files, data-table files, and port configurations.

<sup>2</sup> If you do not update the program, the ControlNet processor will fault.

<sup>3</sup> You must change block-transfer instructions for the ControlNet system from the standard block transfer read (BTR) and block transfer write (BTW) instructions to scheduled transfers or to unscheduled CIO instructions.

<sup>4</sup> You must edit non-ControlNet PLC-5 programs containing references to the I/O Status File for use with I/O connected via the ControlNet network. Information regarding ControlNet status is stored in a separate data file that you specify through the programming software.

<sup>5</sup> If you do not update the program, the data-table locations corresponding to the “missing” I/O devices will not be updated.

### Converting from ControlNet Phase 1.0 or 1.25 to ControlNet Phase 1.5

ControlNet phase 1.0 or 1.25 products will not work in a ControlNet 1.5 system.

To convert ControlNet phase 1.0 or 1.25 to ControlNet phase 1.5, contact your local Rockwell Automation sales office or distributor.

## Notes

## Understanding the ControlNet System Software

### Using This Chapter

This chapter describes the configuration and programming software that you use with your ControlNet PLC-5 processor and specific details about their maintenance. Although the software packages are separate tools, they have specific interdependencies that must be met in order to keep projects synchronized between one another.

### Configuring and Programming Your ControlNet System

Use the following software packages to configure and program your ControlNet system.

Use:	To:
RSNetWorx for ControlNet (henceforth RSNetWorx) software	define ControlNet network parameters, such as: <ul style="list-style-type: none"> <li>• network update time</li> <li>• media redundancy</li> <li>• physical media configuration</li> <li>• maximum scheduled nodes</li> <li>• maximum unscheduled nodes</li> <li>• monitor I/O map entry status</li> </ul>
RSLogix 5 software	<ul style="list-style-type: none"> <li>• enter user program files</li> <li>• create/delete/monitor data table files</li> <li>• enter module configuration</li> <li>• enter channel 0, 1A, 1B, and 3 configuration</li> <li>• administer passwords and privileges</li> </ul>
RSLinx software	provide the ControlNet network interfaces to: <ul style="list-style-type: none"> <li>• poll the network for active devices</li> <li>• monitor station diagnostics</li> </ul>

Additionally, use:

- **RSNetWorx software** to configure the individual scheduled connections for the ControlNet PLC-5. RSNetWorx software creates a project (.xc) file on your personal computer when you save the project. RSNetWorx software writes to the Channel 2 configuration memory during an online save to the ControlNet PLC-5.
- **RSLogix 5 software** to configure and program all other parameters within the ControlNet PLC-5. RSLogix 5 software creates a project (.rsp) file on your personal computer when you save the project.

These two software packages are separate tools because RSNetWorx software is used to configure the entire ControlNet network and RSLogix 5 software is used to configure node-specific information.

Also, the ControlNet network requires that the entire network be configured at one time to make sure all scheduled connections are performed at their configured packet rates.

Two interdependencies exist between RSNetWorx and RSLogix 5 software:

- the I/O configuration utility invoked in RSLogix 5 software
- the ControlNet configuration information is created and saved in RSNetWorx software, but is also saved and downloaded in RSLogix 5 software

### **I/O Configuration Utility**

The I/O configuration utility in RSLogix 5 software is used to simplify the configuration of intelligent I/O modules. It is important to understand the difference between I/O configuration over remote I/O vs. I/O configuration over ControlNet:

- over remote I/O, the information displayed and entered in the configuration applet is always read and written to the data table. Thus, all of the I/O configuration functionality over remote I/O is contained with the RSLogix 5 application.
- over ControlNet, the information displayed and entered in the configuration applet is read and written to **both** the data table and the RSNetWorx project (.xc) file.

The I/O configuration data must be read and written to the RSNetWorx project (.xc) file so that the user can download the I/O configuration data from RSNetWorx software. If the RSNetWorx project (.xc) file was not updated with the I/O configuration edits done within the I/O configuration utility, the edits would be lost when that RSNetWorx project file was downloaded.

You must configure the association to the RSNetWorx project (.xc) file in RSLogix 5 software so that RSLogix 5 software knows which RSNetWorx project (.xc) file to access the I/O configuration information. You can do this within the Controller Properties window in RSLogix 5 software. If you don't use the I/O configuration utility to edit or monitor ControlNet scheduled connections, the association to the RSNetWorx project (.xc) file in RSLogix 5 software is unnecessary.

Certain circumstances can cause the data table configuration information to differ from what is stored in the RSNetWorx project (.xc) file. This can occur when program logic is used to modify the contents of the data table for purposes of reconfiguring a module via a path other than the I/O configuration utility. If such "on the fly" reconfiguration is necessary for your application, consider that subsequently launching the I/O configuration utility applet will result in outdated information being displayed, unless that information has been imported into the RSNetWorx project (.xc) file.

Under these circumstances, consider the following guidelines:

- when configuring intelligent modules over ControlNet, any configuration changes should be performed via a module's respective applet in the I/O configuration utility. This will ensure that the edits are written to both the data table and the RSNetWorx project (.xc) file.
- if you must configure an intelligent module over ControlNet via program logic, you must then upload the online network configuration in RSNetWorx software to synchronize the contents of the data table with the RSNetWorx project (.xc) file. This will ensure that the I/O configuration utility applet will contain current information the next time it is launched.

### **Uploading and Downloading Software Projects**

Considering that both RSLogix 5 and RSNetWorx software can upload and download the ControlNet configuration information, you must make sure that both the RSLogix 5 project (.rsp) file and the RSNetWorx project (.xc) file contain the same ControlNet configuration information. For example, if outdated ControlNet configuration information is present in the RSLogix 5 project (.rsp) file, a download of the RSLogix 5 project may download ControlNet configuration information that does not match the current ControlNet network.

There are two reasons why the RSLogix 5 project (.xc) file contains ControlNet configuration information:

- the RSNetWorx tool can only download to the entire ControlNet network. For example, in an application where a single ControlNet PLC-5 needs to have its program downloaded, RSNetWorx software will attempt to download all nodes on the ControlNet network. This will be time-consuming and require that all ControlNet PLC-5 processors on the ControlNet network be placed in PROGRAM mode.
- the RSLogix 5 software download can download everything to a ControlNet PLC-5 in a single download. If the ControlNet configuration information was not contained within the RSLogix 5 project, both an RSLogix 5 project download and an RSNetWorx project download would be required.

### **Verify that ControlNet PLC-5 Configuration Matches Network Information**

To make sure that the ControlNet configuration information downloaded to the ControlNet PLC-5 processor matches the current ControlNet network information, follow one of these procedures:

### **Download from both RSNetWorx and RSLogix 5 software**

You can download the ControlNet configuration information from RSNetWorx software and the remaining controller information from RSLogix 5 software. When downloading the project from RSLogix 5 software, a dialog box appears and asks whether the ControlNet configuration information stored in the RSLogix 5 project should be downloaded.

With this approach, you will want to keep the existing ControlNet configuration that is currently on the ControlNet PLC-5 processor.

### **Download from RSLogix 5 Software Only**

You can download the entire program from RSLogix 5 software while keeping the ControlNet configuration information up to date. When downloading the ControlNet configuration information from RSLogix 5 software, a dialog box appears and asks whether the ControlNet configuration information stored in the RSLogix 5 project should be downloaded.

With this approach, you will want to overwrite the existing ControlNet configuration that is currently on the ControlNet PLC-5 processor with the ControlNet configuration information that is stored in the RSLogix 5 project (.rsp) file.

The ControlNet configuration information in RSLogix 5 software is kept up to date by uploading from the ControlNet PLC-5 processor and by saving a new RSLogix 5 project (.rsp) file following every save performed in RSNetWorx software, or following an RSNetWorx project download if a save was performed off-line.

**Important:** This approach simplifies the download to a single operation, however it requires the maintenance of keeping the RSLogix 5 project (.rsp) file up to date with the current ControlNet network configuration information for every PLC-5 processor on the ControlNet network. To do this, you must perform the RSLogix 5 upload and save for each and every save performed in RSNetWorx software, even if no ControlNet configuration information changed for any ControlNet PLC-5 processor. This is required because a network keeper signature is reevaluated every save and is unique for every save. The network keeper signature is downloaded to every keeper-capable device on the ControlNet network.

### **Using RSNetWorx Software to Perform Verification Activities After a Download or Save in RSNetWorx Software**

We recommend that you perform two verification activities following a download or save operation in RSNetWorx software:

- **Verify Keeper Signatures**
- **Verify Scanner Signatures**

To verify keeper signatures:

1. In Network menu, choose Keeper Status
2. If any keepers are invalid, select the node(s) and click Update Keeper

To verify scanner signatures:

1. In Network menu, choose Scanner Signature Status
2. If any scanners are invalid, download the RSNetWorx project to the processors that indicate a scanner signature mismatch (you may have to follow additional troubleshooting procedures in RSNetWorx software to correct the scanner signature mismatch).

### **Merge-Save Functionality**

When you add or delete nodes or when you add, modify, or delete I/O map table entries, only those processors on the network whose ControlNet schedules need to change are required to be in Program mode. This feature requires RSNetWorx for ControlNet software version 1.6 or later.

During the save operation, RSNetWorx software gives you two options:

- **Optimize schedule for all connections:** RSNetWorx software recalculates the ControlNet schedule for all the nodes on the ControlNet network. The new schedule is downloaded to all the processors. The processors close all of their existing connections and then reopen their connections according to the new schedule. This option requires that all the processors be in Program mode.
- **Merge changes into existing schedule:** RSNetWorx software merges the pending changes into the current ControlNet schedule. The new schedule is only downloaded to those processors that are affected by the change. Only those processors that are affected by the change have to be in Program mode. All other processors on the network can remain in Run mode and their connections remain open. This option is only available if the current schedule can accommodate the pending changes and if the ControlNet network parameters (such as NUT, maximum scheduled address, maximum unscheduled address, or media redundancy) do not change.

**Important:** Performing a download via RSNetWorx software may require all the processors to be in Program mode.

## **For More Information**

For more information about using these software packages, see the online help systems included with RSNetWorx for ControlNet and RSLogix 5 software.

## Notes



## Programming Your ControlNet System

### Using This Chapter

Topic	Page
ControlNet message instructions	4-1
ControlNet I/O transfer instructions	4-3
ControlNet immediate data input and output instructions	4-6
Using Selectable Timed Interrupts (STIs) in a program on a ControlNet network	4-9
Recovering from Major Fault Codes 200 and 201	4-9

### Using ControlNet Message Instructions

You can use the Message (MSG) instruction and the MG data type to send message commands over the ControlNet system within the local ControlNet link:

- PLC-5 TYPED WRITE
- PLC-5 TYPED READ
- PLC-3 WORD RANGE READ
- PLC-3 WORD RANGE WRITE
- PLC-2 UNPROTECTED READ
- PLC-2 UNPROTECTED WRITE

Use your programming software to go to the instruction entry for message block screen.

If you want to:	Do this:
change the command type	Select one of the following: <ul style="list-style-type: none"> <li>• PLC-5 TYPED WRITE—to select a write operation to another PLC-5 processor</li> <li>• PLC-5 TYPED READ—to select a read operation from another PLC-5 processor</li> <li>• PLC-3 WORD RANGE READ—to select a write operation to another PLC-3 processor</li> <li>• PLC-3 WORD RANGE WRITE—to select a read operation from another PLC-3 processor</li> <li>• PLC-2 UNPROTECTED READ—to select a write operation to another PLC-2 processor</li> <li>• PLC-2 UNPROTECTED WRITE—to select a read operation from another PLC-2 processor</li> </ul>
enter a PLC-5 data table address	Type the PLC-5 data table address.

If you want to:	Do this:
enter the size in elements	Type a number of elements from 1 to 1000.
enter the destination network address	Type a number from 1 to 99.
enter a destination data table address	Type the destination data table address.

The fields of the MG data type that you can directly address are:

Field	Definition	Location
.EW	Enabled-waiting flag bit	word 0, bit 02
.CO	Continuous control bit	word 0, bit 03
.ER	Errored flag bit	word 0, bit 04
.DN	Done flag bit	word 0, bit 05
.ST	Started flag bit	word 0, bit 06
.EN	Enabled flag bit	word 0, bit 07
.TO	Abort (Time out) control bit	word 0, bit 08
.NR	No-response flag bit—not used	word 0, bit 09
.NC	No-cache bit	word 0, bit 10
.ERR	Error-code word	word 1
.RLEN	Requested length word	word 2
.DLEN	Done length word	word 3
.DATA[0] through .DATA[51]	Remaining words	words 4 through 55

For more detailed information about writing ladder programs and using message instructions, see your programming software documentation.

### Multihop Messaging Via the MSG Instruction

You can use the MSG instruction to communicate from a processor on one ControlNet link to a processor on another ControlNet link via ControlBus using 1756-CNB ControlNet bridge modules.

You can also configure a ControlNet ladder MSG instruction to:

- a Data Highway Plus device by bridging across the 1756-CNB(R) and 1756-DHRIO modules
- an Ethernet device by bridging across the 1756-CNB(R) and 1756-ENET modules

Refer to your programming software documentation for information about configuring multihop messages.

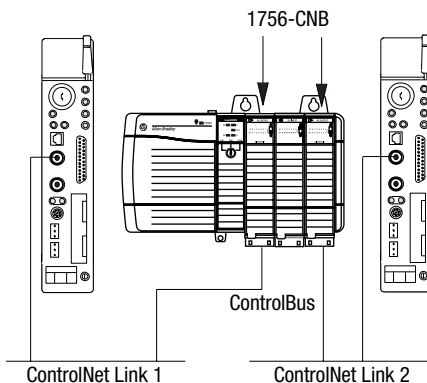

### Option to Close Communication Connection when MSG is Done

This feature allows you to configure the ControlNet ladder MSG instruction to close its communication connection when the message operation is done - thus conserving ControlNet resources on low duty rate messages. Do this by setting the NC configuration bit in the ladder MSG control file.

### Understanding the ControlNet PLC-2 Compatibility File

When a PLC-2 command is received from the ControlNet network, the ControlNet PLC-5 processor uses the user-specified file as the PLC-2 compatibility file. All PLC-2 commands received from the ControlNet network use the same PLC-2 compatibility file. The ControlNet PLC-5 processor uses the value stored in S:73 of the processor status file as the PLC-2 compatibility file number.

The PLC-2 file number must be between 3 and 999, inclusive. The corresponding data table file must exist and be large enough to accommodate the PLC-2 requests. You can use a MOV instruction in the ladder program to update S:73.

The PLC-2 type MSG instructions error if the PLC-2 compatibility file on the target PLC-5 processor is invalid.

Condition PLC-2 Compatibility file number is:	Error Code Returned	Corrective Action
less than 3 or greater than 999	0x8000	Set S:73 to a value between 3 and 999, inclusive.
between 3 and 999, but file does not exist	0x8000	Create the data table file referred by S:73.
between 3 and 999, exists, but file is not large enough	0x5000	Increase the size of the data table file referred by S:73.

### Using the ControlNet I/O Transfer Instruction

You can use the ControlNet I/O Transfer (CIO) instruction and the ControlNet Transfer (CT) data type to make ControlNet I/O transfers within the local ControlNet link. Use your programming software to go to the instruction entry for ControlNet I/O transfer block screen.

If you want to:	Do this:
change the command type	Select one of the following: <ul style="list-style-type: none"> <li>• 1771 READ - reads input data from 1771 non-discrete I/O module</li> <li>• 1771 WRITE - writes output data to 1771 non-discrete I/O module</li> <li>• 1794 READ - reads data from a 1794 I/O module</li> <li>• 1794 WRITE - writes data to a 1794 I/O module</li> <li>• 1794 FAULT ACTION - changes the action that a module takes when it faults</li> <li>• 1794 IDLE ACTION - changes the action that a module takes when it is idle</li> <li>• 1794 CONFIG DATA - changes a module's configuration data</li> <li>• CIP GENERIC - sends user-specified CIP service</li> <li>• 1794 CONFIG DATA - changes a module's configuration data</li> <li>• 1794 SAFE STATE DATA - changes a module's safe-state data</li> <li>• CIP GENERIC - sends user-specified CIP service</li> <li>• GENERIC BI-DIRECTIONAL - sends user-specified CIP service which requires reply data</li> <li>• 1747 READ INPUT - reads data from SLC I/O module input file</li> <li>• 1747 WRITE OUTPUT - writes data to SLC I/O module output file</li> <li>• 1747 READ M0 FILE - reads data from SLC I/O module M0 file</li> <li>• 1747 WRITE M0 FILE - writes data to SLC I/O module M0 file</li> <li>• 1747 READ M1 FILE - reads data from SLC I/O module M1 file</li> <li>• 1747 WRITE M1 FILE - writes data to SLC I/O module M1 file</li> <li>• 1747 SAFE STATE - change SLC I/O module safe state DATA data</li> <li>• 1747 WRITE FLAGS - change action SLC I/O module take when it faults and/or goes to idle</li> <li>• 1747 CONFIG DATA - change SLC module configuration data</li> </ul>
enter a PLC-5 data table address	Type the data table address.
enter the size in elements	Type the number of elements: <ul style="list-style-type: none"> <li>• 0<sup>1</sup> to 64 for 1771 READ or 1771 WRITE</li> <li>• 1 for 1794 FAULT ACTION or 1794 IDLE ACTION</li> <li>• 1 to 15 for 1794 CONFIG DATA or 1794 SAFE STATE DATA</li> <li>• 1 to 16 for 1794 READ or 1794 WRITE</li> <li>• 1 to 32 for 1747 READ INPUT or 1747 WRITE INPUT</li> <li>• 1 to 138 for 1747 READ M0 FILE, 1747 WRITE M0 FILE, 1747 READ M1 FILE, 1747 WRITE M1 FILE</li> <li>• 1 to 138 for 1747 SAFE STATE DATA</li> <li>• 1 for 1747 WRITE FLAGS</li> <li>• 1 to 138 for 1747 CONFIG DATA</li> </ul>
enter the destination network address	Type a number from 1 to 99.
enter the destination slot number	Type the number of the slot that holds the I/O device - number from 0 to 15.

<sup>1</sup> If you enter a 0, the module determines the size of the transfer. In this case, you must make sure that your data table can accommodate up to 64 words.

The fields of the CT data type that you can directly address are:

Field	Definition	Location
.EW	Enabled-waiting flag bit	word 0, bit 02
.CO	Continuous control bit	word 0, bit 03
.ER	Errored flag bit	word 0, bit 04
.DN	Done flag bit	word 0, bit 05
.ST	Started flag bit	word 0, bit 06
.EN	Enabled flag bit	word 0, bit 07
.TO	Abort (Time out) control bit	word 0, bit 08
.ERR	Error-code word	word 1
.RLEN	Requested length word	word 2
.DLEN	Done length word	word 3
.FILE	Transfer file number	word 4
.ELEM	Transfer element number	word 5
.DATA[0] through.DATA[15]	Remaining words	words 6 through 21

The CIP Generic and Generic Bi-directional CIO command types allow you to enter any possible CIP command over the ControlNet network. This allows the processor to send commands to devices not listed in the command type list, or to send special CIP commands to devices. Use of these command types requires specific details of the device to which the command is being sent.

For more detailed information about writing ladder programs, see your programming software documentation.

### **Sending Continuous Messages**

If you use continuous mode message instructions, do not toggle the rung condition unless the continuous message is done or errored. Once enabled, the continuous message will only stop under the following conditions:

- if a message error is detected
- if you reset the message CO bit
- if you set the TO status bit

You can change the CO and TO bits through the message block configuration screen or with ladder logic.

## 1771 ControlNet Transfers in PIs and STIs

When a 1771 Read or 1771 Write CIO instruction is encountered in a PII or STI, the processor resumes execution of lower priority ladder programs (main logic programs) until the CIO is completed. If you want the PII or STI to run to completion before returning to your main logic program, place the CIO instruction inside of a UID/UIE pair in your PII or STI program file.

### Using ControlNet Immediate Data Input and Output Instructions

You can use two instructions for immediate data input and output on a ControlNet network—Immediate Data Input (IDI) and Immediate Data Output (IDO).

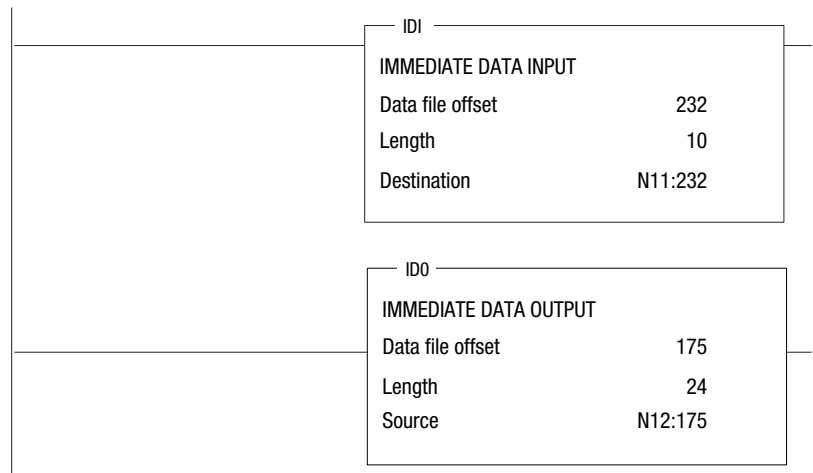

In the previous example, an IDI is initiated that updates the destination file from the private buffer before the next normal input-image update. The Data File Offset (232) is the offset into the buffer where the data is stored. The Length (10) identifies the number of words in the transfer—it can be an immediate value ranging from 1 to 64 or a logical address that specifies the number of words to be transferred. The Destination (N11:232) is the destination of the words to be transferred. The Destination should be the matching data table address in the DIF except when you use the instruction to ensure data-block integrity in the case of Selectable Timed Interrupts (STIs). See Using Selectable Timed Interrupts with a Program on a ControlNet Network on page 4-9.

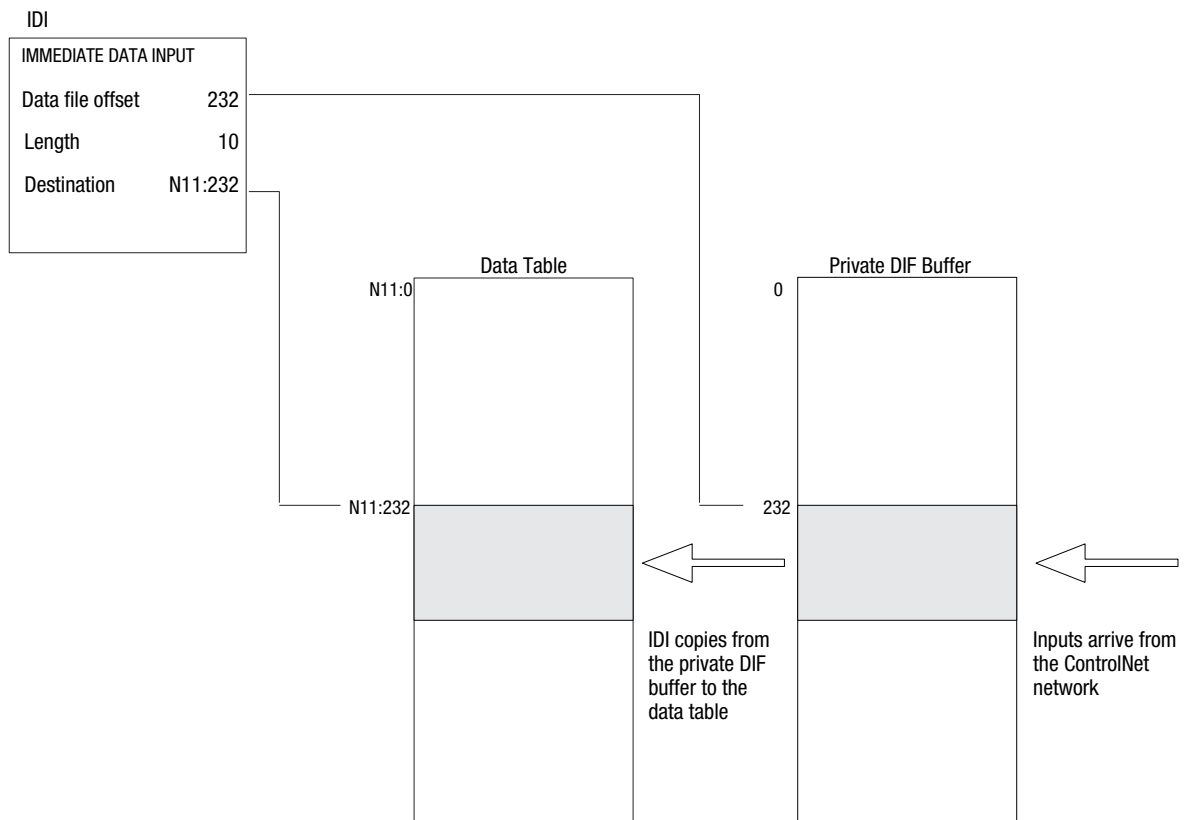

An IDO is initiated that updates the private memory output buffer from the source file before the next normal output-image update. The Data File Offset (175) is the offset into the buffer where the data is stored. The Length (24) identifies the number of words in the transfer or a logical address that specifies the number of words to be transferred. The Source (N12:175) is the source of the words to be transferred. The Source should be the matching data table address in the DOF except when you use the instruction to ensure data-block integrity in the case of Selectable Timed Interrupts (STIs). See Using Selectable Timed Interrupts with a Program on a ControlNet Network on page 4-9

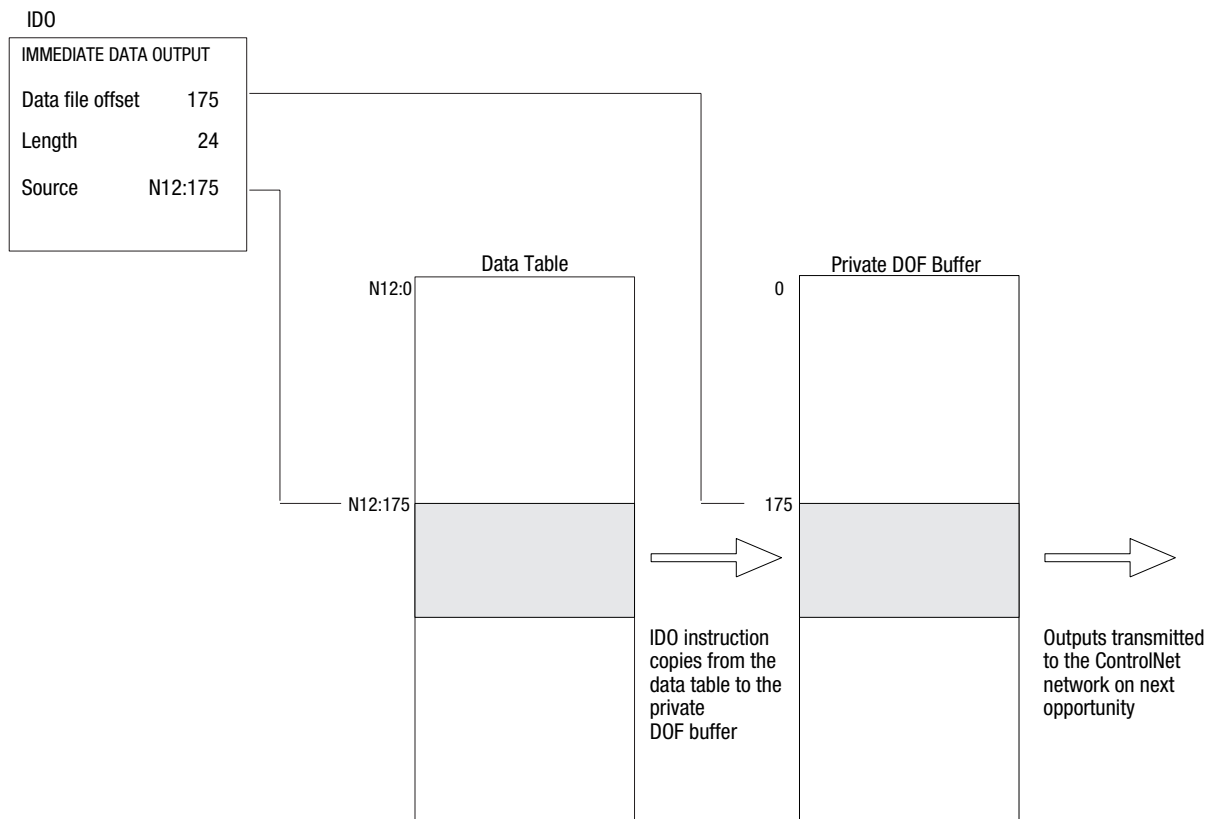

For more detailed information about writing ladder programs and programming ControlNet I/O transfers using Immediate Input (IIN) and Immediate Output (IOT) instructions, see your programming software documentation.



## Using Selectable Timed Interrupts with a Program on a ControlNet Network

You must be careful when using Selectable Timed Interrupts (STIs) with a program on a ControlNet network.

A Selectable Timed Interrupt (STI) periodically interrupts primary program execution in order to run a subprogram to completion. If an STI occurs while a normal ControlNet non-discrete I/O data transfer or a ControlNet Immediate Data I/O instruction (IDO or IDI) is in progress and they both operate on the same set of data, the integrity of that block of data is jeopardized.

To ensure data-block integrity, write your STI routine so that it operates on its own copy of the data block that it needs. Use ControlNet Immediate Data I/O instructions (IDO and IDI) within your STI to copy the needed block of data out to and back from a temporary location that is different from that used by the normal data table.

For detailed information about STIs, see your programming software documentation.

## Recovering from Major Fault 200 and 201

A Major Fault with error code 200 and 201 means that the processor was unable to transmit the scheduled data it is configured to transmit. This is typically caused by disturbances on the ControlNet channel because of missing terminators, bad connectors, or noisy conditions. These disturbances may cause the processor to fall off the network while its trying to transmit its scheduled data. If you consistently get these faults, you may want to check and repair the cable.

This fault can also occur when the processor falls behind and did not have the scheduled data ready to send on time.

Depending on the requirements of the application, you may consider adding a fault routine to the application to clear an occurrence of a Major Fault with error code 200 and 201.

For detailed information about creating fault routines, refer to chapter 16 of the Enhanced and Ethernet PLC-5 Programmable Controllers User Manual, publication 1785-6.5.12.

**Note:** To monitor for ControlNet noise via ladder logic or HMI, declare a ControlNet diagnostic file using RSNetWorx software. Refer to Appendix F: *ControlNet Diagnostic File Layout* for definitions. You can also monitor for ControlNet noise via RSWho's station diagnostics in RSLinx.

## Notes

## Monitoring and Troubleshooting Your ControlNet System

### Using This Chapter

Topic	Page
Using the general status indicators	5-1
Using the ControlNet status indicators	5-3
Using the Data Highway Plus and Remote I/O Status Indicators	5-5
Monitoring the ControlNet configuration and status	5-5
Using the DH+/RIO Status Indicators	5-6

### Using the General Status Indicators

The general status indicators inform you of the general operational state of the processor.

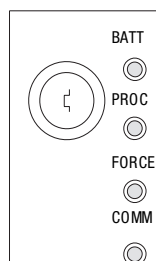

Indicator	Color	Description	Probable Cause	Recommended Action
BATT	Red	Battery low	Battery low	Replace battery within 10 days
	Off	Battery is good	Normal operation	No action required



Indicator	Color	Description	Probable Cause	Recommended Action
PROC	Green (steady)	Processor is in run mode and fully operational	Normal operation	No action required
	Green (blinking)	Processor memory is being transferred to EEPROM	Normal operation	No action required
	Red (blinking)	Major fault	<ul style="list-style-type: none"> <li>RSLogix 5 download in progress</li> <li>Run-time error</li> </ul>	During RSLogix 5 download, this is normal operation - wait for download to complete. If not during RSLogix 5 download: <ul style="list-style-type: none"> <li>Check major fault bit in status file (S:11) for error definition</li> <li>Clear fault, correct problem, and return to run mode</li> </ul>
	Alternating Red and Green	Processor in FLASH-memory programming mode	Normal operation if processor's FLASH memory is being reprogrammed	No action required - allow flash update to complete
	Red (steady)	Power cycle with problem battery	Battery is low, disconnected or not installed	Properly replace or install battery (see Chapter 1 for more information)
	Red (steady)	Fault with memory loss	<ul style="list-style-type: none"> <li>New processor</li> <li>Invalid ControlNet network address</li> <li>Processor has failed internal diagnostics</li> </ul>	<ul style="list-style-type: none"> <li>Use programming software to clear and initialize memory</li> <li>Verify that ControlNet address switch is not set to 0</li> <li>Install battery (to preserve failure diagnostics), then power down, reseal processor and power up; then reload your program. If you are unable to reload your program, replace the processor. If you are able to reload your program and fault persists, contact Technical Support at 440.646.6800 to diagnose the problem.</li> </ul>
	Off	Processor is in program load or test mode or is not receiving power		Check power supply and connections
FORCE	Amber (steady)	SFC and/or I/O forces enabled	Normal operation	No action required
	Amber (blinking)	SFC and/or I/O forces present but not enabled		
	Off	SFC and/or I/O forces not present		
COMM	Off	No transmission on channel 0	Normal operation if channel is not being used	
	Green (blinking)	Transmission on channel 0	Normal operation if channel is being used	

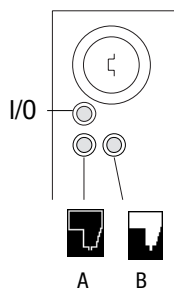

## Using the ControlNet Status Indicators

The ControlNet status indicators inform you of the operational state of the ControlNet network.



Indicator	Color	Description	Probable Cause	Recommended Action
I/O	Off	ControlNet I/O not present or not operating	Normal operation if Channel 2 not being used	No action required
	Steady Green	All nodes configured in the ControlNet map table present and operating properly	Normal operation	No action required
	Flashing Green/Off	At least one node configured for the ControlNet network not present or not operating properly	Cable(s) or connector(s) broken or not connected	Repair or replace cable(s) or connector(s), and reconnect
			Destination module(s) bad or missing	Repair or replace module(s)
Flashing Red/Off	All nodes configured for ControlNet not present or not operating properly	Node(s) not on network	Connect node to network	
		Cable(s) or connector(s) broken or not connected	Repair or replace cable(s) or connector(s), and reconnect	
		Nodes not on network	Connect nodes to network	



Indicator	Color <sup>1</sup>	Probable Cause	Recommended Action	
 and  <b>A</b> and <b>B</b>	Off	Internal diagnostics failed	<ol style="list-style-type: none"> <li>1. Turn power off, make sure ControlNet address is not 00, reseal processor, then power up</li> <li>2. Clear memory and reload your program</li> <li>3. Replace EEPROM with new program</li> <li>4. If still an error, replace the processor</li> </ol>	
		No power	Check power supply	
	Steady Red	Faulted unit	Cycle power or reset unit	If fault persists, contact your Rockwell Automation representative or distributor
			Flashing Green	Normal operation if processor is in FLASH memory program mode
	Flashing Red/Green	The processor's ControlNet address is above UMAX	Configure the ControlNet network so that UMAX is at least as high as the processor's ControlNet address.	
			Set the processor's ControlNet address at or below UMAX.	
	Alternating Red/Green	Self-test	No action required	
Alternating Red/Off	Incorrect node configuration	Check network address and other ControlNet configuration parameters		

Indicator	Color <sup>1</sup>	Probable Cause	Recommended Action
 A                     or  B	Off	Channel disabled	No action required <hr/> Configure for ControlNet communication
	Steady Green	Normal operation	No action required
	Flashing Green/Off	Temporary errors	Make sure that the processor is connected to the ControlNet network with an Allen-Bradley tap. <hr/> Check media for broken cables, loose connectors, missing terminators, etc.
	Flashing Red/Off	Media fault	Make sure that the processor is connected to the ControlNet network with an Allen-Bradley tap. <hr/> Check media for broken cables, loose connectors, missing terminators, etc.
		No other nodes present on network	Add other nodes to the network
Flashing Red/Green	Incorrect network configuration	Cycle power or reset unit <hr/> If fault persists, contact your Rockwell Automation representative or distributor	

<sup>1</sup> Definition of terms:

- **alternating**—the two indicators alternate between the two defined states at the same time (applies to both indicators viewed together); the two indicators are always in opposite states, out of phase
- **flashing**—the indicator alternates between the two defined states (applies to each indicator viewed independent of the other); if both indicators are flashing, they flash together, in phase
- **steady**—indicator is on continuously in the defined state

## Using the DH+/RIO Status Indicators

Indicator	Color	Channel Mode	Description	Probable Cause	Recommended Action		
 or  A or B	Green (steady)	Remote I/O Scanner	Active Remote I/O link, all adapter modules are present and not faulted	Normal operation	No action required		
		Remote I/O Adapter	Communicating with scanner				
		DH+	Processor is transmitting or receiving on DH+ link				
	Green (blinking rapidly or slowly)	Remote I/O Scanner	At least one adapter is faulted or has failed	<ul style="list-style-type: none"> <li>• Power off at remote rack</li> <li>• Cable broken</li> </ul>	<ul style="list-style-type: none"> <li>• Restore power to the rack</li> <li>• Repair cable</li> </ul>		
		DH+	No other nodes on network				
	Red (steady)	Remote I/O Scanner Remote I/O Adapter DH+	Hardware fault	Hardware error	<ul style="list-style-type: none"> <li>• Turn power off, then on.</li> <li>• Check that the software configurations match the hardware set-up.</li> <li>• Replace the processor.</li> </ul>		
Red (blinking rapidly or slowly)		Remote I/O Scanner	Faulted adapters detected			<ul style="list-style-type: none"> <li>• Cable not connected or is broken</li> <li>• Power off at remote racks</li> </ul>	<ul style="list-style-type: none"> <li>• Repair cable</li> <li>• Restore power to racks</li> </ul>
		DH+	Bad communication on DH+				
Off	Remote I/O Scanner Remote I/O Adapter DH+	Channel offline	Channel is not being used	Place channel online if needed			

## Monitoring ControlNet Configuration and Status

Use the following software packages to monitor ControlNet configuration and status information.

Use:	To:
RSNetWorx for ControlNet	define ControlNet network parameters, such as: <ul style="list-style-type: none"> <li>• network update time</li> <li>• media redundancy</li> <li>• physical media configuration</li> <li>• maximum scheduled nodes</li> <li>• maximum unscheduled nodes</li> <li>• monitor I/O map entry status</li> </ul>
RSLogix5	<ul style="list-style-type: none"> <li>• monitor ControlNet diagnostic file<sup>1</sup></li> <li>• enter user program files</li> <li>• create/delete/monitor data table files</li> <li>• enter module configuration</li> <li>• enter channel 0, 1A, 1B, and, 3 configuration</li> <li>• administer passwords and privileges</li> </ul>
RSLinx	to provide the ControlNet network interfaces to: <ul style="list-style-type: none"> <li>• poll the network for active devices</li> <li>• monitor station diagnostics</li> </ul>

<sup>1</sup> It is highly recommended that you declare an extended ControlNet diagnostic file (63 words) using RSNetWorx. This file will allow you to monitor for noise (via ladder and HMI query), to monitor the overall health of scheduled connections (words 40 and 41), and to monitor ControlNet buffer usage.

For information about using these software packages, see the online help systems for RSNetWorx for ControlNet and RSLogix5 software.



## Processor Specifications

<b>Backplane Current</b>	1785-L20C15: 2.7A @ 5Vdc 1785-L40C15, -L46C15, -L80C15: 3.3A @ 5Vdc
<b>Heat Dissipation</b>	1785-L20C15: 54 BTU/hour 1785-L40C15, -L46C15, -L80C15: 59 BTU/hour
<b>Operating Temperature</b>	IEC 60068-2-1 (Test Ad, Operating Cold), IEC 60068-2-2 (Test Bd, Operating Dry Heat), IEC 60068-2-14 (Test Nb, Operating Thermal Shock): 0-60°C (32-140°F)
<b>Storage Temperature</b>	IEC 60068-2-1 (Test Ab, Un-packaged Non-operating Cold), IEC 60068-2-2 (Test Bc, Un-packaged Non-operating Dry Heat), IEC 60068-2-14 (Test Na, Un-packaged Non-operating Thermal Shock): -40 to 85°C (-40 to 185°F)
<b>Relative Humidity</b>	IEC 60068-2-30 (Test Db, Un-packaged Non-operating Damp Heat): 5-95% non condensing
<b>Vibration</b>	IEC60068-2-6 (Test Fc, Operating): 2g @10-500Hz
<b>Shock</b>	IEC60068-2-27:1987, Test Ea (Unpackaged shock, ES#002) Operating - 30g Non-operating - 50g
<b>Emissions</b>	CISPR 11: Group 1, Class A
<b>ESD Immunity</b>	IEC 61000-4-2: 4kV contact discharges
<b>Radiated RF Immunity</b>	IEC 61000-4-3: 10V/m, 3V/m Broadcast Bands, with 1kHz sine-wave 80% AM from 30MHz to 1000MHz
<b>EFT/B Immunity</b>	IEC 61000-4-4: ±2kV at 5kHz on communications ports
<b>Surge Transient Immunity</b>	IEC 61000-4-5: ±2kV line-earth(CM) on signal ports
<b>Conducted RF Immunity</b>	IEC 61000-4-6: 10Vrms with 1kHz sine-wave 80%AM from 150kHz to 30MHz
<b>Enclosure Type Rating</b>	None (open style)
<b>Time-of-Day Clock/Calendar<sup>1</sup></b>	Maximum Variations at 60° C: ±5 min per month Typical Variations at 20° C: ±20 s per month Timing Accuracy: 1 program scan
<b>Available Cartridges</b>	1785-CHBM ControlNet Hot Backup Cartridge <sup>2</sup> (required for each processor used in a hot backup system) 1785-RC Relay Cartridge
<b>Battery</b>	Allen-Bradley 1770-XYC
<b>Memory Modules<sup>3</sup></b>	<ul style="list-style-type: none"> <li>• 1785-ME32</li> <li>• 1785-ME64</li> <li>• 1785-M100</li> </ul>
<b>I/O Modules</b>	Bulletin 1771 I/O, 1794 I/O, 1746 I/O, and 1791 I/O including 8-, 16-, 32-pt, and intelligent modules

<sup>1</sup> The clock/calendar will update appropriately each year.

<sup>2</sup> The 1785-CHBM cannot be used with the 1785-5/60C processor.

<sup>3</sup> The 1785-ME16 cannot be used with ControlNet PLC-5 processors.

<sup>4</sup> For more information, refer to publication 1770-4.1, *Industrial Automation Wiring and Grounding Guidelines*.

<sup>5</sup> See the Product Certification link at <http://www.ab.com> for Declarations of Conformity, Certificates, and other certification details.

<b>Hardware Addressing</b>	2-slot <ul style="list-style-type: none"> <li>• Any mix of 8-pt modules</li> <li>• 16-pt modules must be I/O pairs</li> <li>• No 32-pt modules</li> </ul> 1-slot <ul style="list-style-type: none"> <li>• Any mix of 8- or 16-pt modules</li> <li>• 32-pt modules must be I/O pairs</li> </ul> 1/2-slot—Any mix of 8-,16-, or 32-pt modules	
<b>Communication</b>	<ul style="list-style-type: none"> <li>• Serial</li> <li>• DH+</li> <li>• DH using 1785-KA</li> <li>• Remote I/O</li> <li>• ControlNet</li> </ul>	Wire Category 2 <sup>4</sup>
	<ul style="list-style-type: none"> <li>• Relay Cartridge</li> </ul>	Wire Category 1 <sup>4</sup>
<b>Location</b>	1771-A1B, -A2B, A3B, -A3B1, -A4B chassis; left-most slot	
<b>Weight</b>	PLC-5/20C15: 3 lbs, 3 oz (1.45 kg)	
	PLC-5/40C15: 3 lbs, 2 oz (1.42 kg)	
	PLC-5/46C15: 3 lbs, 2 oz (1.42 kg)	
	PLC-5/80C15: 3 lbs, 2 oz (1.42 kg)	
<b>Keying</b>	<ul style="list-style-type: none"> <li>• Between 40 and 42</li> <li>• Between 54 and 56</li> </ul>	
<b>Certifications (when product is marked)</b>	UL UL Listed Industrial Control Equipment CSA CSA Certified Process Control Equipment CSA CSA Certified Process Control Equipment for Class I, Division 2 Group A,B,C,D Hazardous Locations CE <sup>5</sup> European Union 89/336/EEC EMC Directive, compliant with: EN 50081-2; Industrial Emissions EN 50082-2; Industrial Immunity European Union 73/23/EEC LVD Directive, compliant with: EN 61131-2; Programmable Controllers C-Tick <sup>5</sup> Australian Radiocommunications Act, compliant with: AS/NZS 2064; Industrial Emissions	



<sup>1</sup> The clock/calendar will update appropriately each year.  
<sup>2</sup> The 1785-CHBM cannot be used with the 1785-5/60C processor.  
<sup>3</sup> The 1785-ME16 cannot be used with ControlNet PLC-5 processors.  
<sup>4</sup> For more information, refer to publication 1770-4.1, *Industrial Automation Wiring and Grounding Guidelines*.  
<sup>5</sup> See the Product Certification link at <http://www.ab.com> for Declarations of Conformity, Certificates, and other certification details.

		PLC-5/20C15	PLC-5/40C15	PLC-5/46C15	PLC-5/80C15
<b>Maximum User Memory Words</b>		16K	48K <sup>1</sup>	48K <sup>1</sup>	100K <sup>2</sup>
<b>Maximum Total I/O</b>	<b>Any Mix</b>	512	2048	2048	3072
	<b>Complimentary</b>	512 in and 512 out	2048 in and 2048 out	2048 in and 2048 out	3072 in and 3072 out
<b>Program Scan Time</b>		0.5 ms per K word (bit logic) 2 ms per K word (typical)			
<b>ControlNet I/O<sup>3</sup></b>	<b>Transmission Rate</b>	5M bit/s			
	<b>Network Update Time (NUT)</b>	2-100 ms (user selectable)			
	<b>Number of ControlNet Ports</b>	1 (redundant)			
	<b>Maximum Number of Nodes per Link without a Repeater</b>	48—with 250 m (approx. 820 ft) cable length			
	<b>Maximum Number of Nodes per Link with Repeaters</b>	99			
	<b>Maximum Link Cable Length without a Repeater</b>	1,000 m (approximately 3,280 ft)—with 2 nodes 500 m (approximately 1,640 ft)—with 32 nodes 250 m (approximately 820 ft)—with 48 nodes			
	<b>Maximum Number of I/O Map Entries</b>	64	96	96	128
	<b>Maximum DIF/DOF Size</b>	2000 words	3000 words	3000 words	4000 words
	<b>Maximum Link Cable Length with Repeaters</b>	6,000 m (approximately 19,680 ft)—with 2 nodes 3,000 m (approximately 9,840 ft)—typical			
<b>Remote I/O and DH+</b>	<b>Transmission Rate</b>	57.6K bit/s 115.2K bit/s 230.4K bit/s			
	<b>I/O Scan Time (Typical)</b>	10 ms per rack @ 57.6K bit/s 7 ms per rack @ 115.2K bit/s 3 ms per rack @ 230K bit/s			
	<b>Maximum Number of Remote I/O Racks</b>	3	15	15	23
	<b>Maximum Number of Remote I/O Devices</b>	12	60	60	92
	<b>Number of Ports Configurable for DH+ or Remote I/O (Adapter or Scanner)</b>	1	2	2	2
	<b>Number of Dedicated DH+ Ports</b>	1	0	0	0
<b>Number of Serial Ports</b>		1			
<b>Number of Coprocessor Ports</b>		1			
<b>Maximum Number of MCPs</b>		16			

<sup>1</sup> The PLC-5/40C15 and -5/46C15 processors have a limit of 32K words per data-table file.

<sup>2</sup> The PLC-5/80C15 processor has a limit of 56K words per program file and 32 K words per data table file. The PLC-5/80C processor has 64K words of total data table space.

<sup>3</sup> For more information, see the ControlNet Cable System Planning and Installation Manual, publication 1786-6.2.1.

The following information applies when operating this equipment in hazardous locations:	Informations sur l'utilisation de cet équipement en environnements dangereux:
<p>Products marked "CL I, DIV 2, GP A, B, C, D" are suitable for use in Class I Division 2 Groups A, B, C, D, Hazardous Locations and nonhazardous locations only. Each product is supplied with markings on the rating nameplate indicating the hazardous location temperature code. When combining products within a system, the most adverse temperature code (lowest "T" number) may be used to help determine the overall temperature code of the system. Combinations of equipment in your system are subject to investigation by the local Authority Having Jurisdiction at the time of installation.</p>	<p>Les produits marqués "CL I, DIV 2, GP A, B, C, D" ne conviennent qu'à une utilisation en environnements de Classe I Division 2 Groupes A, B, C, D dangereux et non dangereux. Chaque produit est livré avec des marquages sur sa plaque d'identification qui indiquent le code de température pour les environnements dangereux. Lorsque plusieurs produits sont combinés dans un système, le code de température le plus défavorable (code de température le plus faible) peut être utilisé pour déterminer le code de température global du système. Les combinaisons d'équipements dans le système sont sujettes à inspection par les autorités locales qualifiées au moment de l'installation.</p>
<p><b>WARNING</b></p>  <p><b>EXPLOSION HAZARD</b></p> <ul style="list-style-type: none"> <li>• Do not disconnect equipment unless power has been removed or the area is known to be nonhazardous.</li> <li>• Do not disconnect connections to this equipment unless power has been removed or the area is known to be non-hazardous. Secure any external connections that mate to this equipment by using screws, sliding latches, threaded connectors, or other means provided with this product.</li> <li>• Substitution of components may impair suitability for Class I, Division 2.</li> <li>• If this product contains batteries, they must only be changed in an area known to be non-hazardous.</li> </ul>	<p><b>AVERTISSEMENT</b></p>  <p><b>RISQUE D'EXPLOSION</b></p> <ul style="list-style-type: none"> <li>• Couper le courant ou s'assurer que l'environnement est classé non dangereux avant de débrancher l'équipement.</li> <li>• Couper le courant ou s'assurer que l'environnement est classé non dangereux avant de débrancher les connecteurs. Fixer tous les connecteurs externes reliés à cet équipement à l'aide de vis, loquets coulissants, connecteurs filetés ou autres moyens fournis avec ce produit.</li> <li>• La substitution de composants peut rendre cet équipement inadapté à une utilisation en environnement de Classe I, Division 2.</li> <li>• S'assurer que l'environnement est classé non dangereux avant de changer les piles.</li> </ul>

## Processor Status File

**S:0 - S:2**

Processor status data is stored in data-file 2.

This word of the status file:	Stores:				
S:0	Arithmetic flags <ul style="list-style-type: none"> <li>• bit 0 = carry</li> <li>• bit 1 = overflow</li> <li>• bit 2 = zero</li> <li>• bit 3 = sign</li> </ul>				
S:1	Processor status and flags				
S:1/00	RAM checksum is invalid at power-up				
S:1/01	Processor in run mode				
S:1/02	Processor in test mode				
S:1/03	Processor in program mode				
S:1/04	Processor uploading to memory module				
S:1/05	Processor in download mode				
S:1/06	Processor has test edits enabled				
S:1/07	Mode select switch in REMOTE position				
S:1/08	Forces enabled				
S:1/09	Forces present				
S:1/10	Processor successfully uploaded to memory module				
S:1/11	Performing online programming				
S:1/12	Not defined				
S:1/13	User program checksum calculated				
S:1/14	Last scan of ladder or SFC step				
S:1/15	Processor running first program scan or the first scan of the next step in an SFC				
S:2	Switch setting information				
S:2/00 through S:2/05	Channel 1A DH+ station number				
S:2/06	Channel 1A DH+ baud rate <table style="margin-left: 20px;"> <tr> <td>0</td> <td>57.6 kbps</td> </tr> <tr> <td>1</td> <td>230.4 kbps</td> </tr> </table>	0	57.6 kbps	1	230.4 kbps
0	57.6 kbps				
1	230.4 kbps				



This word of the status file:	Stores:
S:10/04	Edits prevent SFC continuing; data table size changed during program mode; reset automatically in run mode
S:10/05	Invalid I/O status file
S:10/06	reserved
S:10/07	No more command blocks exist to execute block-transfers
S:10/08	Not enough memory on the memory module to upload the program from the processor
S:10/09	No MCP is configured to run
S:10/10	MCP not allowed
S:10/11	PII word number not in local rack
S:10/12	PII overlap
S:10/13	no command blocks exist to get PII
S:10/14	Arithmetic overflow

**S:11**

This word of the status file:	Stores:
S:11	major fault word
S:11/00	Corrupted program file (codes 10-19). See major fault codes (S:12).
S:11/01	Corrupted address in ladder program (codes 20-29). See major fault codes (S:12).
S:11/02	Programming error (codes 30-49). See major fault codes (S:12).
S:11/03	Processor detected an SFC fault (codes 71-79). See major fault codes (S:12).
S:11/04	Processor detected an error when assembling a ladder program file (code 70); duplicate LBLs found.
S:11/05	Start-up protection fault. The processor sets this major fault bit when powering up in Run mode if the user control bit S:26/1 is set.
S:11/06	Peripheral device fault
S:11/07	User-generated fault; processor jumped to fault routine (codes 0-9). See major fault codes (S:12).
S:11/08	Watchdog faulted
S:11/09	System configured wrong (codes 80 - 82, 84 - 88, 200 - 208). See major fault codes (S:12).
S:11/10	Recoverable hardware error
S:11/11	MCP does not exist or is not a ladder or SFC file

This word of the status file:	Stores:
S:11/12	PII file does not exist or is not a ladder file
S:11/13	STI file does not exist or is not a ladder file
S:11/14	Fault routine does not exist or is not a ladder file
S:11/15	Faulted program file does not contain ladder logic

**S:12**

This word stores the following fault codes:

This fault code:	Indicates this fault:	And the fault is:
00-09	<p>Reserved for user-defined fault codes.</p> <p>You can use user-defined fault codes to identify different types of faults or error conditions in your program by generating your own recoverable fault. To use these fault codes, choose an input condition that decides whether to jump to a fault routine file, then use the JSR instruction as the means to jump to the fault routine file.</p> <p>To use the JSR instruction, enter the fault code number 0-9 (an immediate value) as the first input parameter of the instruction. Any other input parameters are ignored (even if you have an SBR instruction at the beginning of your fault routine file. You cannot pass parameters to the fault routine file using JSR/SBR instructions).</p> <p>You do not have to use the user-defined fault codes to generate your own fault. If you program a JSR with no input parameters, the processor will write a zero to the Fault Code field. The purpose of using the user-defined fault codes is to allow you to distinguish among <b>different</b> types of faults or error codes based on the 0-9 fault code numbers.</p> <p>When the input condition is true, the processor copies the fault code number entered as the first input parameter of the JSR instruction into word 12 of the processor status file (S:12), which is the Fault Code field. The processor sets a Major Fault S:11/7 "User-Generated Fault." The processor then faults unless you clear the Major Fault word (S:11) or the specific fault bit via ladder logic in the fault routine.</p>	<p><i>Recoverable:</i> the fault routine can instruct the processor to clear the fault and then resume scanning the program.</p> <p>A fault routine executes when any of these faults occur.</p>



<b>This fault code:</b>	<b>Indicates this fault:</b>	<b>And the fault is:</b>
10	Run-time data table check failed	<p><i>Recoverable:</i> the fault routine can instruct the processor to clear the fault and then resume scanning the program.</p> <p>A fault routine executes when any of these faults occur.</p>
11	Bad user program checksum	
12	Bad integer operand type, restore new processor memory file	
13	Bad mixed mode operation type, restore new processor memory file	
14	Not enough operands for instruction, restore new processor memory file	
15	Too many operands for instructions, restore new processor memory file	
16	Corrupted instruction, probably due to restoring an incompatible processor memory file (bad opcode)	
17	Can't find expression end; restore new processor memory file	
18	Missing end of edit zone; restore new processor memory file	
19	Download aborted	
20	You entered too large an element number in an indirect address	
21	You entered a negative element number in an indirect address	
22	You tried to access a non-existent program file	
23	You used a negative file number, you used a file number greater than the number of existing files, or you tried to indirectly address files 0, 1, or 2	
24	You tried to indirectly address a file of the wrong type	<i>Recoverable</i>
30	You tried to jump to one too many nested subroutine files	<p><i>Non-recoverable:</i> the fault routine will be executed but cannot clear major fault bit 2.</p>
31	You did not enter enough subroutine parameters	
32	You jumped to an invalid (non-ladder) file	
33	You entered a CAR routine file that is not 68000 code	
34	You entered a negative preset or accumulated value in a timer instruction	<i>Recoverable</i>
35	You entered a negative time variable in a PID instruction	
36	You entered an out-of-range setpoint in a PID instruction	
37	You addressed an invalid module in a block-transfer, immediate input, or immediate output instruction	
38	You entered a RET instruction from a non-subroutine file	<p><i>Non-recoverable</i> the fault routine will be executed but cannot clear major fault bit 2.</p>
39	FOR instruction with missing NXT	
40	The control file is too small for the PID, BTR, BTW, or MSG instruction	<i>Recoverable</i>

<b>This fault code:</b>	<b>Indicates this fault:</b>	<b>And the fault is:</b>
41	NXT instruction with missing FOR	<i>Non-recoverable</i> the fault routine will be executed but cannot clear major fault bit 2.
42	You tried to jump to a non-existent label	
43	File is not an SFC	
44	Error using SFR. This error occurs if: <ul style="list-style-type: none"> <li>• you tried to reset into a simultaneous path</li> <li>• you specified a step reference number that is not found or is not tied to a step (it is a transition)</li> <li>• the previous SFR to a different step is not complete</li> </ul>	
45	Invalid channel number entered	<i>Recoverable</i>
46	Length operand of IDI or IDO instruction is greater than the maximum allowed	
47	SFC action overlap. An action was still active when the step became re-activated	<i>Non-recoverable</i>
48-69	Reserved	<i>Recoverable</i>
70	The processor detected duplicate labels	
71	The processor tried to start an SFC subchart that is already running	
72	The processor tried to stop an SFC subchart that isn't running	
73	The processor tried to start more than the allowed number of subcharts	
74	SFC file error detected	
75	The SFC has too many active functions	
76	SFC step loops back to itself.	
77	The SFC references a step, transition, subchart, or SC file that is missing, empty or too small	
78	The processor cannot continue to run the SFC after power loss	
79	You tried to download an SFC to a processor that cannot run SFCs	
80	You have an I/O configuration error	<i>Recoverable</i>
81	You illegally set an I/O chassis backplane switch by setting both switch 4 and 5 on	
82	Illegal cartridge type for selected operation. This error also occurs if the processor doesn't have a memory module, but the backplane switches are set for a memory module. Make sure the backplane switches are correct (set switch 6 ON and switch 7 OFF if the processor doesn't have a memory module).	

This fault code:	Indicates this fault:	And the fault is:
83	User watchdog fault	<i>Recoverable</i>
84	Error in user-configured adapter mode block-transfer	
85	Memory module bad	
86	Memory module is incompatible with host	
87	Scanner rack list overlap	
88	Scanner channels are overloading the remote I/O buffer; too much data for the processor to process. If you encounter fault code 88, be sure you followed proper design guidelines. Specifically, make sure you: <ul style="list-style-type: none"> <li>• group together 1/4-racks and 1/2-racks of each logical rack. Do not intersperse these with other rack numbers</li> <li>• if using complementary I/O addressing, treat complementary rack addresses individually when grouping racks; primary rack numbers are separate from complement rack numbers</li> </ul>	
90	Sidecar module extensive memory test failed. Call your Rockwell Automation representative for service	
91	Sidecar module undefined message type	
92	Sidecar module requesting undefined pool	
93	Sidecar module illegal maximum pool size	
94	Sidecar module illegal ASCII message	
95	Sidecar module reported fault, which may be the result of a bad sidecar program or of a hardware failure	
96	Sidecar module not physically connected to the PLC-5 processor	
97	Sidecar module requested a pool size that is too small for PC <sup>3</sup> command (occurs at power-up)	
98	Sidecar module first/last 16 bytes RAM test failed	
99	Sidecar module-to-processor data transfer faulted	
100	Processor-to-sidecar module transfer failed	
101	Sidecar module end of scan transfer failed	
102	The file number specified for raw data transfer through the sidecar module is an illegal value	
103	The element number specified for raw data transfer through the sidecar module is an illegal value	
104	The size of the transfer requested through the sidecar module is an illegal size	
105	The offset into the raw transfer segment of the sidecar module is an illegal value	
106	Sidecar module transfer protection violation; for PLC-5/26, -5/46, and -5/86 processors only	
200	ControlNet scheduled output data missed. The processor is unable to transmit the scheduled data it is configured to transmit.	<i>Recoverable</i> Check your network for missing terminators or other sources of electrical noise (see the Industrial Automation Wiring and Grounding Guidelines, publication 1770-4.1)

<b>This fault code:</b>	<b>Indicates this fault:</b>	<b>And the fault is:</b>
201	ControlNet input data missed. The processor is unable to process incoming data from the network.	<i>Recoverable</i> Check your network for missing terminators or other sources of electrical noise (see the Industrial Automation Wiring and Grounding Guidelines, publication 1770-4.1).
202	ControlNet diagnostic data missed.	<i>Recoverable</i> Contact your local Rockwell Automation representative if you get this message.
203	ControlNet schedule transmit data overflow.	<i>Recoverable</i> Contact your local Rockwell Automation representative if you get this message.
204	Too many output connections per NUI.	<i>Recoverable</i> Make scheduled outputs with short Requested Packet Intervals longer and reaccept edits for the ControlNet configuration.

This fault code:	Indicates this fault:	And the fault is:
205	<p>ControlNet configuration exceeds processor bandwidth.</p> <p><b>IMPORTANT: Scheduled connections will be closed. You must cycle power, save with RSNetWorx, or download the program to reopen the connections.</b></p> <p>Because the configuration software is unable to accurately predict all the resources that the processor will require to execute your ControlNet configuration software (based on the relative loading on the processor), this fault code is used if the processor determines that your configuration (typically when you accept Channel 2 edits) exceeds the processor's available bandwidth.</p> <p>Typical causes of this error code include:</p> <ul style="list-style-type: none"> <li>• receiving data from the ControlNet network faster than the ControlNet PLC-5 processor can parse it</li> <li>• performing I/O updates too frequently</li> <li>• performing immediate ControlNet I/O ladder instructions too frequently</li> </ul> <p><b>See S:74 and S:75 for additional information.</b></p>	<p><i>Recoverable</i></p> <p>Reduce the number of ControlNet I/O map table entries. Possible ways:</p> <ul style="list-style-type: none"> <li>• using a discrete rack connection instead of multiple discrete module connections</li> <li>• combining multiple I/O racks into a single I/O rack</li> <li>• putting peer-to-peer data in contiguous blocks in the data table so that less send and receive scheduled messages are required</li> </ul> <p>Increase your Network Update Time and/or increase the Requested Packet Intervals for scheduled data transfers in your I/O map table.</p> <p>Increase your ladder program scan by either adding more logic or by increasing the Communications Time Slice (S:77).</p> <p>Reduce the number or frequency of immediate ControlNet I/O ladder instructions that are performed.</p>
206	This error code is reserved.	Contact your local Rockwell Automation representative if you get this message.
207	This error code is reserved.	Contact your local Rockwell Automation representative if you get this message.
208	Too many pending ControlNet I/O connections.	<p><i>Recoverable</i></p> <p>Delete one or more I/O map table entries and reaccept edits for the ControlNet configuration.</p>
230	System attempted transition to Run mode with processor in Invalid backup state.	<p>Change from the Invalid backup state to the No Control backup state before transitioning into Run mode. Refer to the Invalid backup state troubleshooting table later in this chapter.</p>

<b>This fault code:</b>	<b>Indicates this fault:</b>	<b>And the fault is:</b>
231	Bypassed qualification (may occur during race condition when both processors attempt to go into Run mode at the same time).	Transition the PLC-5 processors into Run mode one at a time.
232	Both processors attempted to be primaries.	Check all media for broken cables, loose connectors, missing terminators, etc.
233	ControlNet configuration invalid on transition into Run mode.	Reconfigure the ControlNet channel.
234	Failed Qualification.	Refer to the qualification major faults troubleshooting table later in this chapter.
235	Illegal invalid backup state	Cycle power to the processor. If the fault reoccurs, contact Rockwell Automation Technical Support at 440-646-6800
236	Illegal No Control backup state	Cycle power to the processor. If the fault reoccurs, contact Rockwell Automation Technical Support at 440-646-6800
237	Illegal Primary/Secondary backup state	Cycle power to the processor. If the fault reoccurs, contact Rockwell Automation Technical Support at 440-646-6800
238	Incompatible firmware revisions	Install the same series and revision of firmware into both hot backup PLC-5 processors
239	ControlNet keeper mismatch	Use RSNetworx to make the PLC-5 processor a valid keeper

## S:13-S:24

This word of the status file:	Stores:
S:13	Program file where fault occurred
S:14	Rung number where fault occurred
S:15	VME status file
S:16	I/O status File
S:17	Minor fault (word 2) See also S:10.
S:17/00	BT queue full to remote I/O
S:17/01	Queue full - channel 1A; maximum remote block-transfers used
S:17/02	Queue full - channel 1B; maximum remote block-transfers used
S:17/03	Queue full - channel 2A; maximum remote block-transfers used
S:17/04	Queue full - channel 2B; maximum remote block transfers used
S:17/05	No modem on serial port
S:17/06	<ul style="list-style-type: none"> <li>• Remote I/O rack in local rack table or</li> <li>• Remote I/O rack is greater than the image size. This fault can also be caused by the local rack if the local rack is set for octal density scan and the I/O image tables are smaller than 64 words (8 racks) each.</li> </ul>
S:17/07	Firmware revision for channel pairs 1A/1B or 2A/2B does not match processor firmware revision
S:17/08	ASCII instruction error
S:17/09	Duplicate node address
S:17/10	DF1 master poll list error
S:17/11	Protected processor data table element violation
S:17/12	Protected processor file violation
S:17/13	Using all 32 ControlNet MSGs
S:17/14	Using all 32 ControlNet 1771 CIOs
S:17/15	Using all 8 1794 ControlNet FLEX I/O CIOs
S:18	Processor clock year
S:19	Processor clock month
S:20	Processor clock day
S:21	Processor clock hour
S:22	Processor clock minute

This word of the status file:	Stores:
S:23	Processor clock second
S:24	Indexed addressing offset
S:25	Reserved

**S:26-S:35**

This word of the status file:	Stores:
S:26	User control bits
S:26/00	Restart/continuous SFC: when reset, processor restarts at first step in SFC. When set, processor continues with active step after power loss or change to RUN
S:26/01	Start-up protection after power loss: when reset, no protection. When set, processor sets major fault bit S:11/5 when powering up in run mode.
S:26/02	Define the address of the local rack: when reset, local rack address is 0. When set, local rack address is 1.
S:26/03	Set complementary I/O (series A only): when reset, complementary I/O is not enabled. When set, complementary I/O is enabled.
S:26/04	Local block-transfer compatibility bit: when reset, normal operation. When set, eliminates frequent checksum errors to certain BT modules.
S:26/05	PLC-3 scanner compatibility bit: when set (1), adapter channel response delayed by 1 ms; when reset (0) operate in normal response time.
S:26/06	Data table-modification inhibit bit. When set (1), user cannot edit the data table or modify forces while the processor keyswitch is in the RUN position. You control this bit with your programming software
S:26/07 through S:26/15	Reserved
S:27	Rack control bits: (See also S:7, S:32, S:33, S:34, and S:35) <ul style="list-style-type: none"> <li>• S:27/0-7 - - I/O rack inhibit bits for racks 0-7</li> <li>• S:27/8-15 - - I/O rack reset bits for racks 0-7</li> </ul>
S:28	Program watchdog setpoint
S:29	Fault routine file
S:30	STI setpoint
S:31	STI file number
S:32	Global status bits: (See also S:7, S:27, S:33, S:34, and S:35) <ul style="list-style-type: none"> <li>• S:32/0-7 rack fault bits for racks 10-17 (octal)</li> <li>• S:32/8-15 unused</li> </ul>



This word of the status file:	Stores:
S:33	Rack control bits: (See also S:7, S:27, S:32, S:34, and S:35) <ul style="list-style-type: none"> <li>• S:33/0-7 I/O rack inhibit bits for racks 10-17</li> <li>• S:33/8-15 I/O rack reset bits for racks 10-17</li> </ul>
S:34	Global status bits: (See also S:7, S:27, S:32, S:33, and S:35) <ul style="list-style-type: none"> <li>• S:34/0-7 rack fault bits for racks 20-27 (octal)</li> <li>• S:34/8-15 unused</li> </ul>
S:35	Rack control bits: (See also S:7, S:27, S:32, S:33, and S:34) <ul style="list-style-type: none"> <li>• S:35/0-7 I/O rack inhibit bits for racks 20-27</li> <li>• S:35/8-15 I/O rack reset bits for racks 20-27</li> </ul>

**Important:** Setting inhibit bits in the processor status file (S:27, S:33, or S:35) does not update inhibit bits in the I/O status file.

## S:36-S:78

This word of the status file:	Stores:
S:36 - S:45	Reserved
S:46	PII program file number
S:47	PII module group
S:48	PII bit mask
S:49	PII compare value
S:50	PII down count
S:51	PII changed bit
S:52	PII events since last interrupt
S:53	STI scan time (in ms)
S:54	STI maximum scan time (in ms)
S:55	PII last scan time (in ms)
S:56	PII maximum scan time (in ms)
S:57	User program checksum
S:58	Reserved
S:59	Extended-local I/O channel discrete transfer scan (in ms)
S:60	Extended-local I/O channel discrete maximum scan (in ms)
S:61	Extended-local I/O channel block-transfer scan (in ms)
S:62	Extended-I/O channel maximum block-transfer scan (in ms)
S:63	Protected processor data table protection file number

This word of the status file:	Stores:
S:64	The number of remote block-transfer command blocks being used by channel pair 1A/1B.
S:65	The number of remote block-transfer command blocks being used by channel pair 2A/2B.
S:66	Reserved.
S:68	<p>Installed memory card type. The four most-significant bits indicate memory card type:</p> <p><b>Value:</b>    <b>Memory card type:</b></p> <p>0            No memory card installed</p> <p>1            1785-ME16 installed</p> <p>2            1785-ME32 installed</p> <p>3            1785-ME64 installed</p> <p>4            1785-ME100 installed</p> <p>5            1785-CHBM installed</p> <p>6            1785-RC installed</p> <p>7-15        Reserved</p> <p>When the 1785-RC module is installed, the eight least-significant bits indicate the memory card's status:</p> <p><b>Bit:</b>        <b>Is set when:</b></p> <p>3            the 1785-RC memory card is installed in the processor</p> <p>2            contact is detected closed. The bit resets when contact is detected open</p> <p>1            the relay is driven open. The bit resets when the relay is closed.</p> <p>0            120Vac is present on the memory card. The bit resets when 120Vac is not present on the card.</p> <p>When any other memory card is installed, the bits are undefined</p>
S:72	ControlNet node number of this processor.
S:73	<p>ControlNet PLC-2 compatibility file</p> <p>When a PLC-2 command is received from the ControlNet network, the processor uses this file number. The PLC-2 file number must be between 3 and 999, inclusive.</p>
S:74	<p>Time (in milliseconds) between iterations of the ControlNet subsystem diagnostics</p> <p>When this value exceeds 2000, the processor may major fault with error code 205. See Appendix E, "Fault Codes".</p>
S:75	Maximum amount of time (in milliseconds) between iterations of the ControlNet subsystem diagnostics
S:76	<p>Number of slots in processor-resident local rack</p> <p>0            Illegal</p> <p>1            4 slots</p> <p>2            12 slots</p> <p>3            8 slots</p> <p>4            16 slots</p>
S:77	Communication time slice for communication housekeeping functions (in ms)
S:78	<p>MCP I/O update disable bits</p> <p>Bit 0 for MCP A</p> <p>Bit 1 for MCP B</p> <p>etc.</p>

**S:79-S127**

<b>This word of the status file:</b>	<b>Stores:</b>
S:79	MCP inhibit bits Bit 0 for MCP A Bit 1 for MCP B etc.
S:80-S:127	MCP file number MCP scan time (in ms) MCP max scan time (in ms) The above sequence applies to each MCP; therefore, each MCP has 3 status words. For example, <ul style="list-style-type: none"> <li>word 80: file number for MCP A</li> <li>word 81: scan time for MCP A</li> <li>word 82: maximum scan time for MCP A</li> <li>word 83: file number for MCP B</li> <li>word 84: scan time for MCP B</li> <li>etc.</li> </ul>

## Notes

## ControlNet Instruction Set

For detailed information about the instruction set for programming PLC-5 processors, see the Enhanced and Ethernet PLC-5 Programmable Controllers User Manual, publication 1785-6.5.12, and the PLC-5 Instruction Set Reference, publication 1785-6.1.

### ControlNet I/O Transfer Instruction

Instruction	Description
<div style="border: 1px solid black; padding: 5px; width: fit-content;"> <p style="margin: 0;">CIO</p> <hr style="border: 0; border-top: 1px solid black; margin: 2px 0;"/> <p style="margin: 0;">CNET I/O TRANSFER</p> <p style="margin: 0;">Control block      CT21:50</p> </div>	<p>ControlNet I/O Transfer CT</p> <p><u>Status Bits</u>            TO—Time-Out Bit            EW—Enabled-Waiting Bit            CO—Continuous Bit            ER—Error Bit            DN—Done Bit            ST—Start Bit            EN—Enable Bit</p>
<p>If the input conditions go from false to true, the data is transferred according to the instruction parameters you set when you enter the ControlNet I/O transfer instruction. The Control Block (CT21:50) contains status and instruction parameters.</p> <p>You cannot use N (integer) control blocks on the ControlNet network.</p> <p>For continuous CIOs, condition the rung to be true for only one scan.</p>	

### Message Instructions on a ControlNet Network

Instruction	Description
<div style="border: 1px solid black; padding: 5px; width: fit-content;"> <p style="margin: 0;">MSG</p> <hr style="border: 0; border-top: 1px solid black; margin: 2px 0;"/> <p style="margin: 0;">SEND/RECEIVE MESSAGE</p> <p style="margin: 0;">Control block      MG10:10</p> </div>	<p>Message MSG</p> <p><u>Status Bits</u>            TO—Time-Out Bit            EW—Enabled-Waiting Bit            CO—Continuous Bit            ER—Error Bit            DN—Done Bit            ST—Start Bit            EN—Enable Bit            NC—No Cache Bit</p>
<p>If the input conditions go from false to true, the data is transferred according to the instruction parameters you set when you enter the message instruction. The Control Block (MG10:10) contains status and instruction parameters.</p> <p>You cannot use N (integer) control blocks on the ControlNet network.</p> <p>For continuous MSGs, condition the rung to be true for only one scan.</p>	

## Immediate Data I/O Instructions

Instruction		Description								
<p style="text-align: center;">— IDI —</p> <table border="1"> <tr> <td colspan="2">IMMEDIATE DATA INPUT</td> </tr> <tr> <td>Data file offset</td> <td>232</td> </tr> <tr> <td>Length</td> <td>10</td> </tr> <tr> <td>Destination</td> <td>N11:232</td> </tr> </table>	IMMEDIATE DATA INPUT		Data file offset	232	Length	10	Destination	N11:232	Immediate Data Input IDI	If the input conditions are true, an immediate data input is initiated that updates the destination file from the private buffers before the next normal input-image update. The Data file offset (232) is where the data is stored. The Length (10) identifies the number of words in the transfer—it can be an immediate value ranging from 1 to 64 or a logical address that specifies the number of words to be transferred. The Destination (N11:232) is the destination of the words to be transferred. The Destination should be the matching data-table address in the DIF except when you use the instruction to ensure data-block integrity in the case of Selectable Times Interrupts (STIs). See page 4-8 in the Using ControlNet Immediate Data Input and Output Instructions section.
IMMEDIATE DATA INPUT										
Data file offset	232									
Length	10									
Destination	N11:232									
<p style="text-align: center;">— IDO —</p> <table border="1"> <tr> <td colspan="2">IMMEDIATE DATA OUTPUT</td> </tr> <tr> <td>Data file offset</td> <td>175</td> </tr> <tr> <td>Length</td> <td>24</td> </tr> <tr> <td>Source</td> <td>N12:175</td> </tr> </table>	IMMEDIATE DATA OUTPUT		Data file offset	175	Length	24	Source	N12:175	Immediate Data Output IDO	If the input conditions are true, an immediate data output is initiated that updates the private memory output buffers from the source file before the next normal output-image update. The Data file offset (175) is the offset into the buffer where the data is stored. The Length (24) identifies the number of words in the transfer—it can be an immediate value ranging from 1 to 64 or a logical address that specifies the number of words to be transferred. The Source (N12:175) is the source of the words to be transferred. The Source should be the matching data-table address in the DOF except when you use the instruction to ensure data-block integrity in the case of Selectable Timed Interrupts (STIs). See page 4-8 in the Using ControlNet Immediate Data Input and Output Instructions section.
IMMEDIATE DATA OUTPUT										
Data file offset	175									
Length	24									
Source	N12:175									

## Immediate I/O Execution Times

Instruction:	Processor:	Execution Time (μs)		Words of Memory
		True:	False:	
INN - Immediate Input	PLC-5/20 C15 PLC-5/40C15, -5/46C15 and -5/80C15	389 347	1.1	2
IOT - Immediate Output	PLC-5/20 C15 PLC-5/40C15, -5/46C15 and -5/80C15	323+(14.5 x dis)+(6.7 x DOF) 330+(27.5 x dis)+(13.25 x DOF)	1.1	2
IDI - Immediate Data Input	PLC-5/20 C15 PLC-5/40C15, -5/46C15 and -5/80C15	538+(0.65 x words) 488+(0.65 x words)	1.1	4-7
IDO - Immediate Data Output	PLC-5/20 C15 PLC-5/40C15, -5/46C15 and -5/80C15	286+(1.23 x words)+(14.5 x DOF)+(6.7 x dis) 270+(1.6 x words)+(27.5 x DOF)+(13.25 x dis)	1.1	4-7
words - IDI or IDO transfer length dis - Total number of ControlNet connections using the discrete Output image file DOF - Total number of ControlNet connections using the Data Output File				

## ControlNet I/O Map-Entry Status Words and Error Codes

### I/O Map-Entry Status Words

The ControlNet status file is an integer data-table file that you specify and configure with the I/O map for scheduled-I/O usage. It contains status information about all of the ControlNet network's scheduled I/O connections. Each I/O map-table entry has a status-file offset field pointing to three status words associated with the connection.

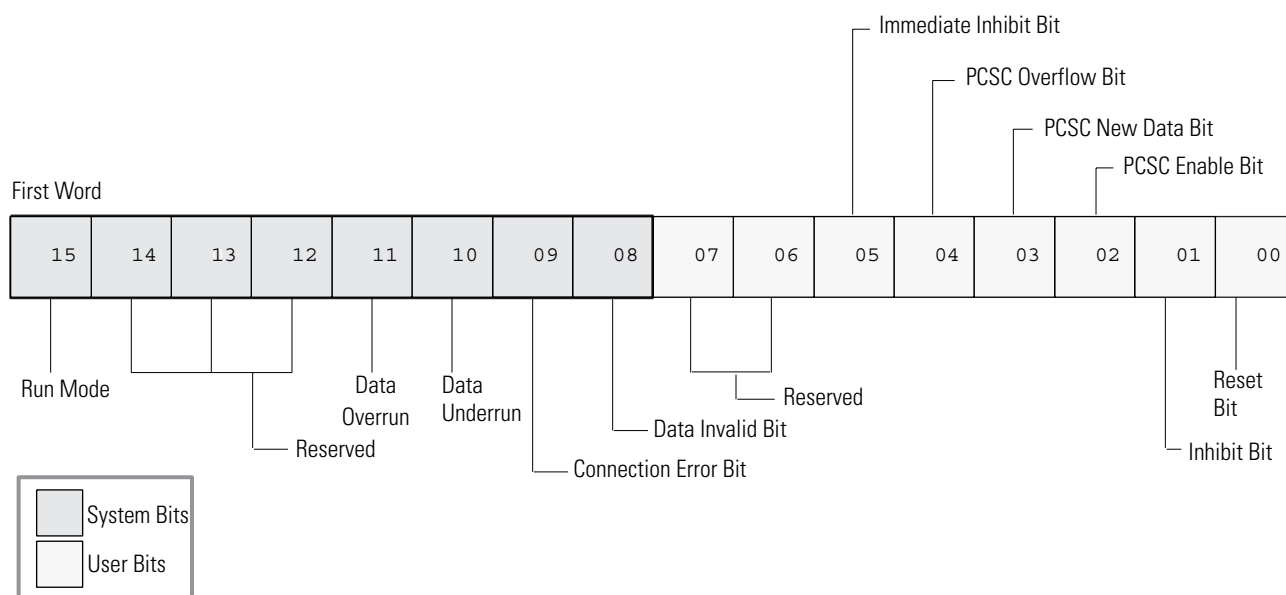

15	14	13	12	11	10	09	08	07	06	05	04	03	02	01	00
Error Messages								07	06	05	04	03	02	01	00
15	14	13	12	11	10	09	08	07	06	05	04	03	02	01	00

For critical I/O points, always condition your logic with bits 8 and 9 of the first ControlNet status word.

The following table explains the bits in the first word of the ControlNet I/O status file:

Bit Number	Description	Use
00	Reset Bit	Set this bit to put the associated connection into PROGRAM mode, even if the processor is in Run mode. Clear this bit to set the mode of the associated connection according to the processor's mode. This bit has no effect for 1771 block transfer modules.
01	Inhibit Bit	Set this bit to perform an orderly shutdown of the associated connection. If the target node is a ControlNet adapter, the adapter will go into idle mode. The processor will not attempt to reopen the connection as long as this bit is set. The processor will also set the Data Invalid Bit and Connection Error Bit. Clear this bit to allow the processor to attempt to open the associated connection.
02	PCSC Enable Bit	Set this bit to enable Process Control Sample Complete for the associated I/O map entry. Clear this bit to disable Process Control Sample Complete for the associated I/O map entry.
03	PCSC New Data Bit	The processor sets this bit when the PCSC Enable Bit is set and new data arrives from the associated connection. Clear this bit when you are finished processing the current sample of data.
04	PCSC Overflow Bit	The processor sets this bit when the PCSC Enable Bit and the PCSC New Data Bits are set and new data arrives from the associated connection. This means that PCSC data is arriving faster than your ladder program is processing it. Clear this bit after you modify your ladder program to handle the incoming PCSC data.
05	Immediate Inhibit Bit	Set this bit to immediately stop communicating on the associated connection. This has the same effect as if you disconnected the target node from the ControlNet network. If the target node is a ControlNet adapter and the adapter is setup for Processor Restart Lockout, the adapter will go into Processor Restart Lockout mode. The processor will not attempt to reopen the connection as long as this bit is set. The processor will also set the Data Invalid Bit and Connection Error Bit. Clear this bit to allow the processor to attempt to open the associated connection.
08	Data Invalid Bit	The processor sets this bit when data is not received from the associated target node. The error code in second and third words of the ControlNet I/O status tells you why the data is invalid. Also, if either the Inhibit Bit or Immediate Inhibit Bit is set, the Data Invalid Bit will be set. The processor clears this bit when valid data is received from the associated target node. In your program, make sure that this bit is clear before you use the associated data.
09	Connection Error Bit	The processor sets this bit when the associated connection is not made to the target node. The error code in second and third words of the ControlNet I/O status tells you why the connection is not made. Also, if either the Inhibit Bit or Immediate Inhibit Bit is set, the Connection Invalid Bit will be set. The processor clears this bit when the associated connection is made to the target node.
10	Data Underrun	This bit is set whenever the length of data received for the associated connection is smaller than expected. The Data Invalid Bit will also be set if the length of data received is less than the value configured in the Input Data Size field for the connection in RSNetworkx.
11	Data Overrun	This bit is set whenever the length of data received for the associated connection is larger than expected. The Data Invalid Bit will not be set.
15	Run Mode	This bit is set to give the Run/Idle status of the target device for connections that support Run/Idle notification (such as Peer-to-Peer Receive Data connections).



The following table explains the second and third status words in the ControlNet I/O status file.

ControlNet I/O Connection Type	Bit 9 of First Word of I/O Status File Entry (Connection Error)	Second Word of I/O Status File Entry	Third Word of I/O Status File Entry
All	Set	0	Error code (see the "Error Messages" section)
Receive Data	Clear	0	0 = peer processor is in PROGRAM mode 1 = peer processor is in RUN mode
Send Data	Clear	0	Number of peer listeners
1747 Discrete	Clear	If bit $x$ is clear, then the module in slot $x$ is OK. If bit $x$ is set, then the module in slot $x$ is missing, bad, or is the wrong type.	
1747 Analog	Clear	0	0
1771 Discrete	Clear	0	0
1771 Analog Read	Clear	0	Error code from read
1771 Analog Write	Clear	Error code from write	0
1771 Analog Read/Write	Clear	Error code from write	Error code from read
1794 Discrete	Clear	0	If bit $x$ is clear, then the module in slot $x$ is OK. If bit $x$ is set, then the module in slot $x$ is missing, bad, or is the wrong type.
1794 Analog Read	Clear	0	If bit $x$ is clear, then the module in slot $x$ is OK. If bit $x$ is set, then the module in slot $x$ is missing, bad, or is the wrong type.
1794 Analog Write	Clear	0	0
1794 Analog Read/Write	Clear	0	If bit $x$ is clear, then the module in slot $x$ is OK. If bit $x$ is set, then the module in slot $x$ is missing, bad, or is the wrong type.

## Error Codes

The following is a list of ControlNet error codes, messages, possible causes, and possible corrective actions. These errors can originate in either the PLC-5 programmable controller or the target device:

Decimal Code	Hex. Code	Error Message	Explanation/Possible Cause(s)	Possible Corrective Action(s)
VARIOUS	VARIOUS	CONFIGURATION DATA CORRUPTED	The ControlNet configuration is corrupted.	Reenter the map entry that is failing.
				Reenter the ladder instruction that is failing.
1	0x0001	CONNECTION FAILED	The ControlNet cable from the originating node to the target node is broken or disconnected.	Fix and/or reconnect the ControlNet cable.
			The target node is not powered.	Supply power to the target node.
			The target's node number is greater than SMAX.	Reconfigure the ControlNet network so that the target's node number is less than or equal to SMAX.
5	0x0005	UNKNOWN DESTINATION ADDRESS	The slot addressed does not exist.	Use a rack with more slots.
				Correct the I/O map table.
			The map table is corrupted.	Reenter the I/O map entry that is failing.
			The target node of the MSG instruction is not a processor or the target node of the CIO instruction is not the correct I/O adapter.	Edit the ladder program so that the correct target node is used.  Replace the target node with the correct type of node.
12	0x000C	OBJECT IN WRONG STATE	The target Scheduled Peer Output map entry is inhibited.	Clear the inhibit and immediate inhibit bits for the target Scheduled Peer Output map entry.
14	0x000E	ATTRIBUTE CANNOT BE SET	A CIO instruction attempted to set an attribute that cannot be set at the destination module. For example, a CIO tried to send safe-state data to a Flex module that does not support safe-state data.	Insert a module that can have this attribute set into the correct slot.
				Edit the ladder program so that it does not attempt to set this attribute.
19	0x0013	NOT ENOUGH DATA	The transfer length is zero.	Increase the transfer length.
			The processor data table is too small to hold the data to be transferred.	Increase the size of the data table to accommodate the transfer length.
21	0x0015	TOO MUCH DATA	The transfer length is too large.	Decrease the transfer length.

Decimal Code	Hex. Code	Error Message	Explanation/Possible Cause(s)	Possible Corrective Action(s)
38	0x0026	INVALID DESTINATION ADDRESS SIZE	The map table is corrupted.	Reenter the I/O map entry that is failing.
			The target node of the MSG instruction is not a processor or the target node of the CIO instruction is not the correct I/O adapter.	Edit the ladder program so that the correct target node is used.  Replace the target node with the correct type of node.
256	0x0100	CONNECTION IN USE	The connection at the target node is already in use.	No action is required. The connection can be re-established after the target node times out the old connection.
262	0x0106	CONNECTION USED BY OTHER NODE	The originating node attempted to use a connection that is already being used by another node.	Delete or inhibit any other node's connection so that the preferred node can establish the connection.
			A non-discrete connection is setup to a discrete module.	Replace the target module with the correct non-discrete module.  Correct the I/O map table.
263	0x0107	CONNECTION NOT FOUND	The connection at the target node does not exist.	Make sure I/O map entries exist in the I/O map tables of both the originating and target nodes.
265	0x0109	INVALID CONNECTION SIZE	The originating node requested a connection size that the target node cannot accommodate.	Correct the connection size in the map table. If it is a listen-only connection, make sure that the connection size is not larger than the size of the controlling connection.
				Set the addressing mode switches of the 1771 rack dip correctly.
				Use a rack with the correct number of slots.
273	0x0111	INVALID RPI	The target node cannot produce the data at or faster than the requested packet interval (RPI) entered in the map table.	Increase the requested packet interval (RPI) entered in the map table.
275	0x0113	OUT OF CONNECTIONS	The maximum number of connections to/from this node has been exceeded.	Reduce the number of I/O connections, MSG instructions, or CIO instructions to/from this node.
276	0x0114	PRODUCT CODE MISMATCH	The target node/module does not match the node/module entered in the map table.	Replace the target node/module with the correct node/module.
277	0x0115	PRODUCT TYPE MISMATCH		Correct the I/O map table.
278	0x0116	REVISION MISMATCH	The series/revision of the target node/module does not match the series/revision entered in the map table.	Replace the target node/module with the correct node/module.
				Correct the I/O map table.

Decimal Code	Hex. Code	Error Message	Explanation/Possible Cause(s)	Possible Corrective Action(s)
279	0x0117	INVALID CONNECTION POINT	The PLC-5C is requesting data from a ControlLogix tag that does not exist.	Change the PLC-5C I/O map entry to use the correct tag.
				Change or add the tag to the ControlLogix processor.
			The PLC-5C does not support ControlNet hot backup. Refer to publication 1785-6.5.24 for more information.	Verify that the PLC-5C is a Series F PLC-5/40C or -5/80C.
				Verify that the 1785-CHBM Hot Backup module is properly installed.
		The target node does not support ControlNet Hot Backup.	Replace the target node with one that supports ControlNet Hot Backup.	
280	0x0118	INVALID CONFIGURATION FORMAT	The target node/module does not match the node/module entered in the map table.	Replace the target node/module with the correct node/module.
				Verify that the target node/module is powered up.
				Correct the map table.
281	0x0119	OWNER CONNECTION NOT OPEN	The originating node attempted to open a listen-only connection before the owner connection was opened.	Correct any connection errors associated with the owner connection.
			The CIO instruction failed because the 1771 discrete rack has no owner.	In the I/O map table, add a discrete connection for the 1771 I/O rack.
			The ControlNet cable from the controlling node to the target node is broken or disconnected.	Fix and/or reconnect the ControlNet cable.
			The controlling node is not powered.	Supply power to the controlling node.
			The target 1771 adapter is in Processor Restart Lockout.	Press the reset button on the target 1771 adapter.
			Cycle power to the target 1771 adapter.	
282	0x011A	OUT OF APPLICATION CONNECTIONS	The maximum number of connections to/from this node has been exceeded.	<ul style="list-style-type: none"> <li>If this is an I/O connection, reduce the number of I/O connections.</li> <li>If this is a MSG instruction, reduce the number of MSG instructions.</li> <li>If this is a CIO instruction, reduce the number of CIO instructions.</li> </ul>
515	0x0203	CONNECTION TIMED OUT	The ControlNet cable from the originating node to the target node is broken or disconnected.	Fix and/or reconnect the ControlNet cable.
			The target node is not powered.	Supply power to the target node.

Decimal Code	Hex. Code	Error Message	Explanation/Possible Cause(s)	Possible Corrective Action(s)
516	0x0204	UNCONNECTED REQUEST TIMED OUT	The ControlNet cable from the originating node to the target node is broken or disconnected.	Fix and/or reconnect the ControlNet cable.
			The target node is not powered.	Supply power to the target node.
			The originator's and/or the target's node number is greater than UMAX.	Reconfigure the ControlNet network so that the originator's and target's node numbers are less than or equal to UMAX.
			The target node is too busy to respond.	Reduce the number of unconnected requests to the target node.
769	0x0301	OUT OF BUFFER MEMORY	The maximum number of connections to/from this node has been exceeded.	<ul style="list-style-type: none"> <li>If this is an I/O connection, reduce the number of I/O connections.</li> <li>If this is a MSG instruction, reduce the number of MSG instructions.</li> <li>If this is a CIO instruction, reduce the number of CIO instructions.</li> </ul>
770	0x0302	SCHEDULED BANDWIDTH NOT AVAILABLE	There are too many words scheduled for transmission.	Edit the I/O map table to reduce the number of scheduled words.
			The network update time (NUT) is too small.	Increase the network update time (NUT).
			The originator's and/or the target's node number is greater than SMAX.	Reconfigure the ControlNet network so that the originator's and target's node numbers are less than or equal to SMAX.
772	0x0304	NO SCHEDULED CONFIGURATION	The ControlNet cable from the originating node to the keeper was broken or disconnected when the ControlNet network was configured.	Fix and/or reconnect the ControlNet cable and reconfigure the ControlNet network.
			The keeper was not powered when the ControlNet network was configured.	Supply power to the keeper and reconfigure the ControlNet network.
			The originating and/or target node is not properly configured to send scheduled data.	Edit the I/O map table of the originating and/or target nodes to send scheduled data.
773	0x0305	SCANNER SIGNATURE MISMATCH	The ControlNet cable from the originating node to the keeper was broken or disconnected when the ControlNet network was configured.	Fix and/or reconnect the ControlNet cable. Reconfigure the ControlNet network by enabling and accepting edits with RSNetWorx.
			The ControlNet processor was not configured on the current network.	Reconfigure the ControlNet network by enabling and accepting edits with RSNetWorx.
			The ControlNet network was formed by joining two existing ControlNet networks.	Reconfigure the new ControlNet network by enabling and accepting edits with RSNetWorx.

Decimal Code	Hex. Code	Error Message	Explanation/Possible Cause(s)	Possible Corrective Action(s)
774	0x0306	KEEPER NOT AVAILABLE	The ControlNet cable from the originating node to the keeper is broken or disconnected.	Fix and/or reconnect the ControlNet cable.
			The keeper is not powered.	Supply power to at least one ControlNet processor.
			No keeper exists on the ControlNet network.	Add at least one ControlNet processor to the network. Reconfigure the ControlNet network by enabling and accepting edits with RSNetWorx.
789	0x0315	INVALID PATH SEGMENT TYPE	The map table is corrupted.	Reenter the I/O map entry that is failing.
			The target node of the CIO instruction is not the correct I/O adapter.	Edit the ladder program so that the correct target node is used. Replace the target node with the correct adapter.
791	0x0317	INVALID SCHEDULE DATA	The ControlNet cable from the originating node to the programming terminal was broken or disconnected when the ControlNet network was configured.	Fix and/or reconnect the ControlNet cable and reconfigure the ControlNet network.
			The originating node was not powered when the ControlNet network was configured.	Supply power to the originating node and reconfigure the ControlNet network.
797	0x31D	INVALID TARGET TAG	The PLC-5C is requesting data from a ControlLogix tag that is not configured as a producer.	Change the PLC-5C I/O map entry to use the correct tag. Reconfigure the tag in the ControlLogix processor to be a producer.
		REDUNDANT CONNECTION MISMATCH	Configuration for this redundant connection does not match the configuration used by the Hot Backup partner.	Change the PLC-5C I/O map and module configuration data to match the Hot Backup partner.
798	0x31E	TAG IS ALREADY PRODUCED THE MAXIMUM NUMBER OF TIMES	The PLC-5C is requesting data from a ControlLogix tag that is already being produced the maximum number of times.	In the ControlLogix processor, increase the number of times this tag can produce data.
65522	0xFFF2	CONFIGURATION FROM MAP ENTRY FAILED	The ControlNet cable from the originating node to the target node is broken or disconnected.	Fix and/or reconnect the ControlNet cable.
			The target node is not powered.	Supply power to the target node.
			The target slot is empty.	Insert the proper module in the correct slot of the target node.
			The target slot contains the wrong module type.	
			An incorrect module or slot was entered in the map table.	Edit the I/O map table to show the correct module type and slot.

Decimal Code	Hex. Code	Error Message	Explanation/Possible Cause(s)	Possible Corrective Action(s)
65523	0xFFFF3	CONTROLNET TRANSFER QUEUE FULL	The immediate CIO instruction could not be executed because the queue is full.	Edit the ladder program so that the number of active 1771 READ/WRITE CIO instructions is equal to or less than the maximum of 32.
65527	0xFFFF7	MODULE TIMED OUT	The target slot is empty.	Insert the proper module in the correct slot of the target node.
			The target slot contains the wrong module type.	
			An incorrect module or slot was entered in the map table.	Edit the I/O map table to show the correct module type and slot.
65529	0xFFFF9	COMMUNICATION ERROR CAUSED LOSS OF DATA	A communication error between the adapter and the module caused the transfer to be aborted.	Make sure that the module is properly seated in the correct slot of the target node.
				Make sure that the adapter's power supply is providing the proper voltage.
			The target slot contains the wrong module type.	Insert the proper module in the correct slot of the target node.
			An incorrect module or slot was entered in the I/O map table.	Edit the I/O map table to show the correct module type and slot.

Decimal Code	Hex. Code	Error Message	Explanation/Possible Cause(s)	Possible Corrective Action(s)
65530	0xFFFA	MODULE DECLARED INVALID LENGTH	A communication error between the adapter and the module caused the transfer to be aborted.	Make sure that the module is properly seated in the correct slot of the target node.
				Make sure that the adapter's power supply is providing the proper voltage.
			The target slot contains the wrong module type.	Insert the proper module in the correct slot of the target node.
			An incorrect module or slot was entered in the map table.	Edit the I/O map table to show the correct module type and slot.
65531	0xFFFB	INVALID READ DATA	A communication error between the adapter and the module caused the transfer to be aborted.	Make sure that the module is properly seated in the correct slot of the target node.
				Make sure that the adapter's power supply is providing the proper voltage.
			The target slot contains the wrong module type.	Insert the proper module in the correct slot of the target node.
			An incorrect module or slot was entered in the map table.	Edit the I/O map table to show the correct module type and slot.
65532	0xFFFC	INVALID WRITE DATA	A communication error between the adapter and the module caused the transfer to be aborted.	Make sure that the module is properly seated in the correct slot of the target node.
				Make sure that the adapter's power supply is providing the proper voltage.
			The target slot contains the wrong module type.	Insert the proper module in the correct slot of the target node.
			An incorrect module or slot was entered in the map table.	Edit the I/O map table to show the correct module type and slot.
65533	0xFFFD	DATA TABLE TOO SMALL	The processor data table is too small to hold the data to be transferred.	Increase the size of the data table to accommodate the transfer length.



## Notes



## Fault Codes

Fault routines execute when a PLC-5 processor encounters a run-time error (major fault) during program execution.

A fault routine processes the major fault bit found in S:11 and determines the course of program execution based on the fault bit present. Fault routines provide a means to either:

- systematically shut down a process or control operation
- log and clear the fault and continue normal operation

For more information about fault routines, see Enhanced and Ethernet PLC-5 Programmable Controllers User Manual, publication 1785-6.5.12.

## Clearing Faults

When a major fault occurs, you need to clear faults before your process can continue.



**ATTENTION:** Clearing a major fault does **not** correct the **cause** of the fault. Be sure to examine the fault bit and correct the cause of the fault before clearing it. For example, if a major fault is encountered that causes bit S:11/2 to be set, which indicates a *programming error*, **do not** use a routine to clear the fault until you correct your program.

## Additional Major Fault Codes

The processor stores fault codes in word 12 of the processor status file (S:12). The following table lists new major fault codes specific to the ControlNet processor.

This fault code:	Indicates this fault:	Take this corrective action:
200	ControlNet scheduled output data missed. The processor is unable to transmit the scheduled data it is configured to transmit.	Check your network for missing terminators or other sources of electrical noise (see the Industrial Automation Wiring and Grounding Guidelines, publication 1770-4.1)
201	ControlNet input data missed. The processor is unable to process incoming data from the network	Check your network for missing terminators or other sources of electrical noise (see the Industrial Automation Wiring and Grounding Guidelines, publication 1770-4.1).
202	This error code is reserved.	Contact your local Rockwell Automation representative if you get this message.
203	This error code is reserved.	Contact your local Rockwell Automation representative if you get this message.
204	Too many output connections per NUI.	Make scheduled outputs with short Requested Packet Intervals longer and reaccept edits for the ControlNet configuration.

This fault code:	Indicates this fault:	Take this corrective action:
205	<p>ControlNet configuration exceeds processor resources.</p> <p><b>IMPORTANT: Scheduled connections will be closed. You must cycle power, save with RSNetWorx, or download the program to reopen the connections.</b></p> <p>Because the configuration software is unable to accurately predict all the resources that the processor will require to execute your ControlNet configuration software (based on the relative loading on the processor), this fault code is used if the processor determines that your configuration (typically when you accept Channel 2 edits) exceeds the processor's available bandwidth.</p> <p>Typical causes of this error code include:</p> <ul style="list-style-type: none"> <li>• receiving data from the ControlNet network faster than the ControlNet PLC-5 processor can parse it</li> <li>• performing I/O updates too frequently</li> <li>• performing immediate ControlNet I/O ladder instructions too frequently.</li> </ul> <p><b>See S:74 and S:75 for more information.</b></p>	<ul style="list-style-type: none"> <li>• Reduce the number of ControlNet I/O map table entries. Possible ways to do this include: <ul style="list-style-type: none"> <li>- using a discrete rack connection instead of multiple discrete module connections</li> <li>- combining multiple I/O racks into a single I/O rack</li> <li>- putting peer-to-peer data in contiguous blocks in the data table so that less send and receive scheduled messages are required</li> </ul> </li> <li>• Increase your Network Update Time and/or increase the Requested Packet Intervals for scheduled data transfers in your I/O map table.</li> <li>• Increase your ladder program scan by either adding more logic or by increasing the Communications Time Slice (S:77).</li> <li>• Reduce the number or frequency of immediate ControlNet I/O ladder instructions that are performed.</li> </ul>
206	This error code is reserved.	Contact your local Rockwell Automation representative if you get this message.
207	This error code is reserved.	Contact your local Rockwell Automation representative if you get this message.
208	Too many pending ControlNet I/O connections.	Delete one or more I/O map table entries and reaccept edits for the ControlNet configuration.
230	System attempted transition to Run mode with processor in Invalid backup state.	Change from the Invalid backup state to the No Control backup state before transitioning into Run mode. Refer to the Invalid backup state troubleshooting table later in this chapter.
231	Bypassed qualification (may occur during race condition when both processors attempt to go into Run mode at the same time).	Transition the PLC-5 processors into Run mode one at a time.
232	Both processors attempted to be primaries.	Check all media for broken cables, loose connectors, missing terminators, etc..
233	ControlNet configuration invalid on transition into Run mode.	Reconfigure the ControlNet channel.
234	Failed Qualification.	Refer to the qualification major faults troubleshooting table later in this chapter.
235	Illegal invalid backup state	Cycle power to the processor. If the fault reoccurs, contact Rockwell Automation Technical Support at 440-646-6800
236	Illegal No Control backup state	Cycle power to the processor. If the fault reoccurs, contact Rockwell Automation Technical Support at 440-646-6800
237	Illegal Primary/Secondary backup state	Cycle power to the processor. If the fault reoccurs, contact Rockwell Automation Technical Support at 440-646-6800
238	Incompatible firmware revisions	Install the same series and revision of firmware into both hot backup PLC-5 processors
239	ControlNet keeper mismatch	Use RSNetworx to make the PLC-5 processor a valid keeper

## ControlNet Diagnostics File Layout

When you specify a Control Diagnostic File in RSNetWorx for the ControlNet network, the PLC-520C, -5/40C, -5/46C or -5/80C processor copies the 40 words of diagnostic counters into the specified integer file.

Twenty-three additional diagnostic counters are available in the ControlNet diagnostic file. To access these counters, you must first use RSLogix5 to increase the size of the ControlNet diagnostic integer file to 63 words.

The layout of the ControlNet diagnostic file is described in the following table. The processor updates this file once every second.

Field Names	File Offset <sup>1</sup> (word;bits)
Buffer Errors	0;15-00
Last 8 Nodes from which bad packets were received	1-4;
Good Frames Transmitted (center significant byte)	5;07-00
Good Frames Transmitted (least significant byte)	5;15-08
Good Frames Received (least significant byte)	6;07-00
Good Frames Transmitted (most significant byte)	6;15-08
Good Frames Received (most significant byte)	7;07-00
Good Frames Received (center significant byte)	7;15-08
Channel A Errors	8;07-00
Bad Received Frames	8;15-08
Aborted Frames Transmitted	9;07-00
Channel B Errors	9;15-08
NUI Overloads	10;07-00
Highwaters/Out-of-Steps	10;15-08
Blockages	11;07-00
Slot Overloads	11;15-08
Aborted Frames Received	12;07-00
Non-Concurrences	12;15-08
Frames with Duplicate Node Address Received	13;07-00
Lonely Occurrences	13;15-08
Collisions	14;07-00
Noise Hits	14;15-08
Moderators from non-lowmen	15;07-00

<b>Field Names</b>	<b>File Offset<sup>1</sup> (word;bits)</b>
Node Address of current Moderator	15;15-08
Cannot Hear Moderator Occurrences (i.e., Lonely)	16;07-00
Network Parameter Mismatch Occurrences	16;15-08
Reserved	17;07-00
SM Commands Received from the wire	17;15-08
Reserved	18;07-00
Reserved	18;15-08
Fault Register -- Pre Reset	19;07-00
Reserved	19;15-08
Reserved	20;07-00
Fault Register -- Post Reset	20;15-08
Dirty bits	21;7-0
SMAC version number	21;15-8
Interface mode	22;7-0
Toggle bits	22;15-8
Channel status (see following table)	23;7-0
Media bits (see following table)	23;15-8
Keeper State	24
Reserved	25-39
Current number of open scheduled connections (always less than or equal to the number in Word 41)	40
Current number of configured scheduled connections	41
Accumulated number of scheduled connection timeouts	42
Current number of active MSG instructions (always less than or equal to 32)	43
Maximum number of simultaneously active MSG instructions (always less than or equal to 32)	44
Accumulated number of MSG connection timeouts	45
Current number of active 1771 CIO instructions (always less than or equal to 32)	46
Maximum number of simultaneously active 1771 CIO instructions (always less than or equal to 32)	47
Accumulated number of 1771 CIO connection timeouts	48
Current number of active 1794 and CIP CIO instructions (always less than or equal to 8)	49
Maximum number of simultaneously active 1794 and CIP CIO instructions (always less than or equal to 8)	50
Accumulated number of 1794 and CIP CIO connection timeouts	51
Current number of open target Message Router connections (always less than or equal to 32)	52

Field Names	File Offset <sup>1</sup> (word;bits)
Maximum number of simultaneously open target Message Router connections (always less than or equal to 32)	53
Accumulated number of target Message Router connection timeouts	54
Current number of used unconnected clients (always less than or equal to 8)	55
Maximum number of simultaneously used unconnected clients (always less than or equal to 8)	56
Accumulated number of unconnected client timeouts	57
Current number of used unconnected servers (always less than or equal to 20)	58
Maximum number of simultaneously used unconnected servers (always less than or equal to 20)	59
Accumulated number of unconnected server timeouts	60
Accumulated number of dropped unconnected requests	61
Accumulated number of JITT overruns	62

<sup>1</sup> The file offset in the user-specified ControlNet diagnostics file. For example, if you specified N12, then the Buffer Errors would be located in N12:0, bits 15 - 00.

The following table describes each bit in word 23 (Channel status and Media bits) of the diagnostic file.

Bit(s):	Description:	Values:
2 - 0	channel A LED state	000 = off 001 = green
5 - 3	channel B LED state	010 = flashing green/off 011 = flashing red/off 100 = flashing red/green 101 = railroading red/off 110 = railroading red/green 111 = red
6	redundancy warning	0 = normal 1 = non-selected channel is unusable
7	active channel	0 = channel B active 1 = channel A active
8	repeater mode	0 = device set for normal mode 1 = device set for repeater mode
9	channel A media mode	0 = configured for Coaxial 1 = configured for fiber
10	channel B media mode	0 = configured for Coaxial 1 = configured for fiber
15 - 11	reserved	

**Note: A value of 219 in word 23 indicates that the ControlNet network is not usable.**

## Notes



## Numerics

**1747 modules**  
 discrete I/O data transfer mapping 2-20

**1770-CD** 1-15, 1-23

**1770-KFC Communication Interface** 2-31

**1771 modules**  
 discrete I/O data transfer mapping 2-20

**1771-ACN and -ACNR ControlNet I/O Adapters** 2-31

**1771-AF** 1-14

**1771-AS** 1-14

**1771-ASB** 1-14

**1771-DCM** 1-14

**1771-SN** 1-14

**1772-SD, -SD2** 1-14

**1775-S4A, -S4B** 1-14

**1775-SR** 1-14

**1784-CP13** 1-20, 1-23

**1784-KTC Communication Card** 2-31

**1784-KTx** 1-20, 1-23

**1784-KTxD** 1-20, 1-23

**1784-PCC Communication Card** 2-31

**1784-PCM5** 1-20, 1-23

**1784-PCM6** 1-20, 1-23

**1784-PCMK** 1-20, 1-23

**1786-BNC -BNC Connector** 1-24

**1786-BNCJ -BNC Connector** 1-24

**1786-BNCJI -BNC Connector** 1-24

**1786-BNCP -BNC Connector** 1-24

**1786-CP** 1-21

**1786-CP ControlNet Network Access Cable** 1-24

**1786-CTK ControlNet Tool Kit** 1-24

**1786-RG6 Quad Shield Cable** 1-24

**1786-RPA Repeater** 1-24

**1786-TPR Tap** 1-17, 1-24

**1786-TPS Tap** 1-17, 1-24

**1786-TPVR Tap** 1-24

**1786-TPVS Tap** 1-24

**1786-TPYR Tap** 1-17

**1786-TPYS Tap** 1-17

**1786-XT BNC Terminator** 1-24

**1794 FLEX I/O data transfer mapping** 2-20

**1794 FLEX I/O data transfer mapping** 2-20

**1794 modules**  
 discrete I/O data-transfer mapping 2-20

**1794-ACN ControlNet FLEX I/O Adapter** 2-31

**6008-SQH1, -SQH2** 1-14

## A

**automatic I/O mapping** 2-16

## B

**battery compartment**  
 location of  
 on PLC-5/20C 1-3  
 on PLC-5/40C 1-4

**battery status** 5-1

## C

**cables**  
 remote I/O 1-13

**cabling** 1-23

**catalog numbers**  
 ControlNet PLC-5 processors P-1

**Channel 1A** 2-34

**Channel 1B** 2-34

**CIOs** 2-4

**clearing faults** E-1

**Closing ControlNet communication** 4-3

**communication**  
 time slice B-14

**Communication Connection, closing** 4-3

**communication connection, closing** 4-3

**communication ports**  
 location of  
 on PLC-5/20C 1-3  
 on PLC-5/40C 1-4

**communication, option to close** 4-3

**configuration software** 3-1

**configuration utility** 3-2

**connecting a programming terminal**  
 1-19

**connecting to a ControlNet network**  
 1-17

**connection**  
 definition of P-2

**connection error bit** D-2

**Conserving ControlNet resources** 4-3

**ControlNet**  
 diagnostics counters F-1  
 diagnostics file layout F-1  
 Scheduled Data Transfer 2-2

**ControlNet cabling** 1-23

**ControlNet communication, closing** 4-3

**ControlNet diagnostics file layout** F-1

**ControlNet I/O**

- error messages D-4
- features 2-1
- files configured with map
  - Data Input File (DIF) 2-18, 2-19
  - Data Output File (DOF) 2-18, 2-19
  - Default Configuration File 2-18
  - I/O Status File 2-18
- I/O forcing 2-7
- immediate data transfer operations 2-8
- map table
  - creating 2-16
  - entries 2-16
- mapping scheduled data transfers 2-16
- scheduled data transfer operations 2-2, 2-4
- scheduled operations
  - discrete I/O data transfer 2-4
  - nondiscrete I/O data transfer 2-4
  - peer-to-peer communication 2-4
- understanding 2-1
- unscheduled data transfer operations 2-4
- unscheduled non-discrete I/O data transfer 2-4
- unscheduled operations
  - ControlNet I/O Transfer (CIO) instruction
    - description C-1
  - ControlNet I/O Transfer (CIO) instructions
    - description 2-6
    - features 2-6
  - I/O transfer instructions
    - programming 4-3
  - immediate data I/O instructions
    - programming 4-6
  - ladder rung messages 2-4
  - messaging from programming
    - devices 2-4
  - non-discrete I/O data transfers 2-6
    - description C-1
    - features C-1
  - peer-to-peer messaging 2-4, 2-7

- peer-to-peer messaging instructions
  - 4-1
  - programming C-1

**ControlNet I/O automatic mapping 2-16****ControlNet I/O mapping**

- automatic 2-16
- reserving rack space for remote I/O linked racks before mapping 2-16
- understanding 2-16
  - discrete I/O data transfer mapping 2-19
  - mapping data transfers 2-18
  - non-discrete I/O data transfer mapping 2-19, 2-20

**ControlNet I/O status file D-2****ControlNet I/O Transfer (CIO)**

- instructions** 2-4, 2-6, 4-3, C-1

**ControlNet immediate data I/O**

- instructions
  - Immediate Data Input (IDI) C-2
  - Immediate Data Output (IDO) C-2
- process C-2

**ControlNet immediate data I/O****instructions**

- process 2-9

**ControlNet Immediate Data Input (IDI)**

- instruction** 2-9

**ControlNet Immediate Data Output (IDO)**

- instruction** 2-9

**ControlNet network**

- definition of P-2
- locating additional information P-4

**ControlNet network examples 2-32****ControlNet PLC-5 configuration**

- matches network information 3-3

**ControlNet PLC-5/20C processor 1-3****ControlNet PLC-5/40C processor 1-4****ControlNet processor**

- configuring your ControlNet system 3-1
- installing 1-1
- planning to use 2-1
- programming your system 4-1

**ControlNet publications P-4****ControlNet status processor**

**ControlNet system**

- cabling 1-23
- configuring 3-1
  - changing a 1794 I/O modules fault action 2-6, 4-4
  - changing a 1794 I/O modules idle action 2-6, 4-4
- configuring nodes 2-16
- locating additional information P-4
- monitoring 5-1
- network maintenance 2-5
- network update cycle
  - what happens in 2-5
- scheduled operations 2-5
- selecting devices to connect 2-31
- troubleshooting 5-1
- unscheduled operations 2-5
- using ControlNet PLC5 processors in 2-31

**ControlNet system software 3-1****ControlNet, conserving resources 4-3****Converting**

- ControlNet phase 1.0 or 1.25 to 1.5 2-35
- non-ControlNet to ControlNet system 2-34

**D****Data Highway Plus status indicators 5-5****Data Input File**

- definition P-2
- description 2-18, 2-19

**data invalid bit D-2****Data Output File**

- definition P-2
- description 2-18, 2-19

**data overrun D-2****data underrun D-2****Default Configuration File**

- description 2-18

**diagnostics file layout**

- ControlNet F-1

**DIF P-2, 2-18, 2-19****diganostics counters F-1****discrete I/O data transfer**

definition of P-2

description 2-4

**discrete I/O data transfer mapping 2-19****distributed keeper**

functionality 2-33

**DOF P-2, 2-18, 2-19****download from RSLogix 5 3-3****download software projects 3-3****drop cable**

definition of P-2

**E****error codes D-4****error codes 200 and 201 4-9****Expected Network Packet Time**

- 1771 non-discrete I/O data transfer mapping 2-21

**F****fault codes E-1****fault codes 200 and 201 4-9****fault routines E-1****files**

- configured with I/O map for scheduled I/O usage 2-18
- Data Input 2-18, 2-19
- Data Output 2-18, 2-19
- Default Configuration 2-18
- I/O Status 2-18, 2-35, D-1
- I/O status 2-18
- processor status B-1

**frame**

definition of P-2

**front panel**

- PLC-5/20C processor 1-3
- PLC-5/40C processor 1-4

**G****global status bits**

- racks 07 B-2
- racks 1017 B-12

- I**
- I/O**
    - ControlNet 2-1
      - automatic mapping 2-16
      - discrete I/O data transfer mapping 2-19
      - files configured with map
        - Data Input File (DIF) 2-18, 2-19
        - Data Output File (DOF) 2-18, 2-19
        - Default Configuration File 2-18
        - I/O Status File 2-18
      - I/O forcing 2-7
      - immediate data transfer 2-8
      - map table
        - creating 2-16
        - entries 2-16
        - maximum number of entries 2-18
      - mapping 2-16
      - mapping data transfers 2-18
      - non-discrete I/O data transfer mapping 2-19, 2-20
      - reserving rack space for remote I/O
        - linked racks before mapping 2-16
      - scheduled data transfer 2-2
      - scheduled operations
        - discrete I/O data transfer 2-4
        - non-discrete I/O data transfer 2-4
        - peer-to-peer communication 2-4
      - unscheduled
        - I/O data transfer instructions 4-3
        - immediate data I/O instructions 4-6
        - Message instruction 2-7, 4-1, C-1
        - non-discrete I/O data transfers 2-6, C-1
        - non-discrete I/O data transfer instructions 4-3
      - unscheduled data transfer 2-4
      - unscheduled non-discrete I/O data transfer 2-4
      - unscheduled operations
        - messaging from programming devices 2-4
        - non-discrete I/O data transfer 2-4
        - peer-to-peer messaging 2-4
    - I/O configuration utility** 3-2
    - I/O forcing** 2-7
    - I/O map table**
      - definition of P-2
    - I/O map entry status words** D-1
    - I/O mapping techniques** 2-21
    - I/O status indicator** 5-3
    - IDI** 2-9
    - IDO** 2-9
    - IIN** 2-9
    - Immediate Data Input (IDI) instruction** C-2
    - Immediate Data Output (IDO) instruction** C-2
    - immediate data transfer operations** 2-8
    - immediate I/O**
      - process 2-9
    - immediate inhibit bit** D-2
    - Immediate Input (IIN) instruction** 2-9
    - Immediate Output (IOT) instruction** 2-9
    - indicators**
      - PLC-5/20C 1-3
      - PLC-5/40C 1-4
    - inhibit bit** D-2
    - installed memory card type**
      - using status to determine B-14
    - installing keying bands for the processor** 1-10
    - installing your processor**
      - checking your processor package 1-5
      - connecting a programming terminal 1-19
        - ControlNet connection 1-21
        - DH+ connection 1-19
        - serial channel 1-20
      - connecting to a ControlNet network 1-17
      - identifying the components of the processor 1-3
      - installing a DH+ link 1-15
      - installing a remote I/O link 1-13
      - installing keying bands for the processor 1-10
      - installing the processor in the chassis 1-13

- locating additional information 1-1
  - removing the processor from the chassis 1-13
  - selecting cables
    - ControlNet cables 1-23
    - DH+ programming 1-23
    - remote I/O 1-23
    - serial 1-22
  - selecting the ControlNet network address 1-12
  - selecting the DH+ station address of Channel 1A 1-11
  - setting the I/O chassis backplane switches 1-9
  - setting the I/O chassis configuration plug 1-10
  - specifying the serial interface of Channel 0 1-12
- instructions**
- ControlNet I/O Transfer (CIO) 2-6, C-1
    - how to use 4-3
    - when to use 2-20, 2-35
  - ControlNet Immediate Data Input (IDI) 2-9, C-2
    - how to use 4-6
  - ControlNet Immediate Data Output (IDO) 2-9, C-2
    - how to use 4-6
  - ControlNet Message (MSG)
    - how to use 4-1
  - Immediate Input (IIN) 2-9
  - Immediate Output (IOT) 2-9
  - Message (MSG) 2-7
    - how to use C-1
    - when to use 2-21
- IOT** 2-9
- K**
- keeper**
- definition P-2
- keeper signature**
- verification 3-4
- keyswitch**
- location of
    - on PLC-5/20C 1-3
    - on PLC-5/40C 1-4
- L**
- ladder rung messaging** 2-4
- link**
- definition of P-2
- M**
- major fault 200 and 201** 4-9
- major fault codes** E-1
- map table** 2-16
- maptable entries** 2-16
- maptable entry** P-2
- memory card type**
- using status file to determine B-14
- memory module space** 1-3, 1-4
- merge-save functionality** 3-5
- Message instructions** 2-4, 2-7, 4-1, C-1
- monitoring ControlNet system** 5-1
- MSGs** 2-4
- multicast** 2-14
- multicast inputs** 2-14
- multicast outputs** 2-14
- N**
- NAP** P-2
- Network Access Port**
- definition of P-2
- network address**
- definition of P-2
- network examples** 2-32
- Network Update Interval** 2-5
- definition of P-2
- Network Update Time**
- definition of P-3
- node**
- definition of P-3
- non-discrete I/O data transfer** P-3, 2-4
- non-discrete I/O data transfer mapping** 2-20
- non-redundant media** 1-17
- NUI** P-2, 2-5
- NUT** P-3
- O**
- Option to Close Communication** 4-3
- owner**
- definition of P-3

**P**

- PCMCIA Communication Card** 2-31
- PCSC** 2-9
  - considerations 2-11
- PCSC enable bit** D-2
- PCSC new data bit** D-2
- PCSC overflow bit** D-2
- Peer In** 2-21
- Peer Out** 2-21
- performing verification activities** 3-4
- PLC-5**
  - using in a ControlNet system 2-31
- PLC-5 catalog numbers** P-1
- PLC-5 processors** P-4
- PLC-5 programming software** P-4
- PLC-5 publications** P-4
- Process Control Sample Complete** 2-9
- processor**
  - definition P-3
  - front panel
    - PLC-5/20C 1-3
    - PLC-5/40C 1-4
  - specifications A-1
- processor status file** B-1
  - layout B-1
- processor resident local I/O** 2-16
- processors**
  - ControlNet PLC-5 programmable controllers P-1
- programming a processor**
  - through Channel 0 1-20
- programming software** 3-1
- programming terminal**
  - connecting 1-19
- publications**
  - ControlNet cabling 1-25
  - ControlNet system 1-18

**R**

- rack control bits**
  - racks 07 B-12
  - racks 1017 B-13
- recovery**
  - fault codes 200 and 201 4-9
- redundant media** 1-17
  - definition of P-3
- redundant media example** 2-32
- related ControlNet publications** P-4
- related PLC-5 publications** P-4

**remote I/O**

- cable lengths 1-13
  - nonControlNet 2-17
- remote I/O status indicators** 5-5
- remote I/O immediate I/O transfers** 2-8, 4-8
- repeater**
  - definition of P-3
- replacing a non-ControlNet remote I/O network with a ControlNet network** 2-16, 2-34, 2-35
- Requested Packet Interval**
  - definition P-3
- reset bit** D-2
- RSLinux software** 3-1
- RSLogix software** 3-1
- RSNetWorx for ControlNet software** 3-1
- RSNetWorx to perform verification activities** 3-4

**S**

- scan list configuration**
  - definition P-2
- scan list entry**
  - definition P-2
- scanner signature**
  - verification 3-4
- scheduled connection types**
  - definition P-3
- Scheduled Data Transfer**
  - definition 2-2
- scheduled data transfer operations** 2-2, 2-4
- scheduled maximum node**
  - definition P-3
- scheduled peer-to-peer communication** 2-4
- scheduled peer-to-peer communications** 2-21
- scheduled peer-to-peer communications mapping** 2-21
- scheduled transfers**
  - definition of P-3
- screens**
  - Instruction Entry for ControlNet I/O Transfer Block 4-3
  - Instruction Entry for Message Block 4-1
- segment**
  - definition of P-3

- terminating 1-17
- Selectable Timed Interrupts (STIs)**
  - using with ControlNet system 4-9
- selecting the DH+ station address of Channel 1A** 1-11
- setting the I/O chassis backplane switches** 1-9
  - addressing switches 1-9
  - EEPROM transfer switches 1-9
  - last state switch 1-9
  - processor memory protection switch 1-9
- setting the I/O chassis configuration plug** 1-10
- SMAX**
  - definition P-3
- Software** 3-1
- specifications**
  - PLC-5 A-1
- specifying the serial interface of Channel 0** 1-12
- status**
  - layout for the processor B-1
- Status File** D-1
  - I/O
    - description 2-18
- status file**
  - processor B-1
- status indicators**
  - location of
    - on PLC-5/20C 1-3
    - on PLC-5/40C 1-4
  - PLC-5 5-1
  - using 5-1, 5-3
- status words**
  - I/O map entry D-1

## T

- tap** 1-21
  - connecting 1-17
  - definition of P-3
  - using 1-17
- terminator**

- definition of P-3
- troubleshooting ControlNet system** 5-1
- trunk cable**
  - definition of P-3
- trunkcable section** P-3

## U

- UMAX**
  - definition P-3
- Unscheduled Data Transfer**
  - definition 2-4
- unscheduled data transfer operations** 2-4
- unscheduled maximum node**
  - definition P-3
- unscheduled non-discrete I/O data transfer** 2-4
- unscheduled transfers**
  - definition of P-3
- upload/download software projects** 3-3
- user control bits**
  - processor status file B-12
- using ControlNet I/O Transfer (CIO) instructions** 4-3
- using ControlNet Immediate Data I/O instructions** 4-6
- using ControlNet Message (MSG) instructions** 4-1
- using the ControlNet status indicators** 5-3
- using the general status indicators** 5-1
- using this manual**
  - conventions used P-4
  - intended audience for P-1
  - introduction to P-1
  - recommended preparation for P-1

## V

- verification activities** 3-4
- verify keeper signature** 3-4
- verify scanner signature** 3-4





# How Are We Doing?

Your comments on our technical publications will help us serve you better in the future. Thank you for taking the time to provide us feedback. You can complete this form and mail (or fax) it back to us or email us at [RADocumentComments@ra.rockwell.com](mailto:RADocumentComments@ra.rockwell.com).

Pub. Title/Type ControlNet PLC-5 Programmable Controllers

Cat. No. 1785-L20C15,  
1785-L40C15,  
1785-L46C15,  
1785-L80C15      Pub. No. 1783-UM001A-EN-P      Pub. Date April 2008      Part No. \_\_\_\_\_

Please complete the sections below. Where applicable, rank the feature (1=needs improvement, 2=satisfactory, and 3=outstanding).

<b>Overall Usefulness</b>	1	2	3	How
				_____
<b>Completeness</b> (all necessary information is provided)	1	2	3	Can we add more information to help you?
				procedure/step      illustration      feature
				example      guideline      other
				explanation      definition
				_____
				_____
<b>Technical Accuracy</b> (all provided information is correct)	1	2	3	Can we be more accurate?
				text      illustration
				_____
				_____
<b>Clarity</b> (all provided information is easy to understand)	1	2	3	How can we make things clearer?
	_____			
	_____			
				_____
<b>Other Comments</b>	You can add additional comments on the back of this form.			
	_____			
	_____			

Your Name \_\_\_\_\_  
 Your Title/Function \_\_\_\_\_  
 Location/Phone \_\_\_\_\_

Would you like us to contact you regarding your comments?  
 No, there is no need to contact me  
 Yes, please call me  
 Yes, please email me at \_\_\_\_\_  
 Yes, please contact me via \_\_\_\_\_

Return this form to: Rockwell Automation Technical Communications, 1 Allen-Bradley Dr., Mayfield Hts., OH 44124-9705  
 Fax: 440-646-3525      Email: [RADocumentComments@ra.rockwell.com](mailto:RADocumentComments@ra.rockwell.com)

PLEASE FASTEN HERE (DO NOT STAPLE)

Other Comments

PLEASE FOLD HERE

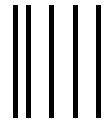

NO POSTAGE  
NECESSARY  
IF MAILED  
IN THE  
UNITED STATES

PLEASE REMOVE

**BUSINESS REPLY MAIL**

FIRST-CLASS MAIL PERMIT NO. 18235 CLEVELAND OH

POSTAGE WILL BE PAID BY THE ADDRESSEE

**Rockwell  
Automation**

1 ALLEN-BRADLEY DR  
MAYFIELD HEIGHTS OH 44124-9705

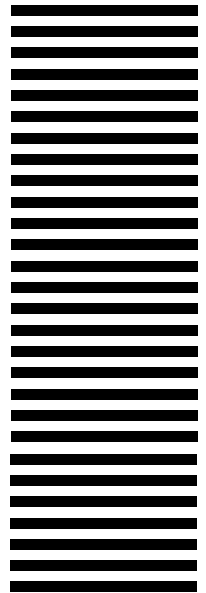

## Notes

# Rockwell Automation Support

Rockwell Automation provides technical information on the Web to assist you in using its products. At <http://support.rockwellautomation.com>, you can find technical manuals, a knowledge base of FAQs, technical and application notes, sample code and links to software service packs, and a MySupport feature that you can customize to make the best use of these tools.

For an additional level of technical phone support for installation, configuration, and troubleshooting, we offer TechConnect support programs. For more information, contact your local distributor or Rockwell Automation representative, or visit <http://support.rockwellautomation.com>.

## Installation Assistance

If you experience a problem within the first 24 hours of installation, please review the information that's contained in this manual. You can also contact a special Customer Support number for initial help in getting your product up and running.

United States	1.440.646.3434 Monday – Friday, 8am – 5pm EST
Outside United States	Please contact your local Rockwell Automation representative for any technical support issues.

## New Product Satisfaction Return

Rockwell Automation tests all of its products to ensure that they are fully operational when shipped from the manufacturing facility. However, if your product is not functioning and needs to be returned, follow these procedures.

United States	Contact your distributor. You must provide a Customer Support case number (call the phone number above to obtain one) to your distributor in order to complete the return process.
Outside United States	Please contact your local Rockwell Automation representative for the return procedure.

[www.rockwellautomation.com](http://www.rockwellautomation.com)

### Power, Control and Information Solutions Headquarters

Americas: Rockwell Automation, 1201 South Second Street, Milwaukee, WI 53204-2496 USA, Tel: (1) 414.382.2000, Fax: (1) 414.382.4444

Europe/Middle East/Africa: Rockwell Automation, Vorstlaan/Boulevard du Souverain 36, 1170 Brussels, Belgium, Tel: (32) 2 663 0600, Fax: (32) 2 663 0640

Asia Pacific: Rockwell Automation, Level 14, Core F, Cyberport 3, 100 Cyberport Road, Hong Kong, Tel: (852) 2887 4788, Fax: (852) 2508 1846

Publication 1785-UM022C-EN-P - February 2008

Supersedes Publication 1785-UM022B-EN-P - February 2002

Copyright © 2008 Rockwell Automation, Inc. All rights reserved. Printed in the U.S.A.